

Section - 06



Pages 319-392

- ★ Amputation, Elevators, Raspatories, Saws, Bone Livers, Bone Files & Curettes
- ★ Mallets, Tampers, Chisels, Gauges, Bone Holding Forceps, Bone Rongeurs, Bone Cutting Forceps, Meniscus Instruments
- ★ Wire Extension, Finger Nail Instruments



Amputation and Resection Knives



Double Cutting

1/2

1/2

1/2

1/2

06-8001
Length of blade
Phalangeal knife
105 mm

06-8002
Length of blade
Interosseous knife
110 mm

06-8003
Length of blade
Periosteum knife
with raspator
65 mm

06-8004 - 06-8005
LANGENBECK
Length of blades
Resection knives
55 mm

06-8004

06-8005



Amputation Retractors

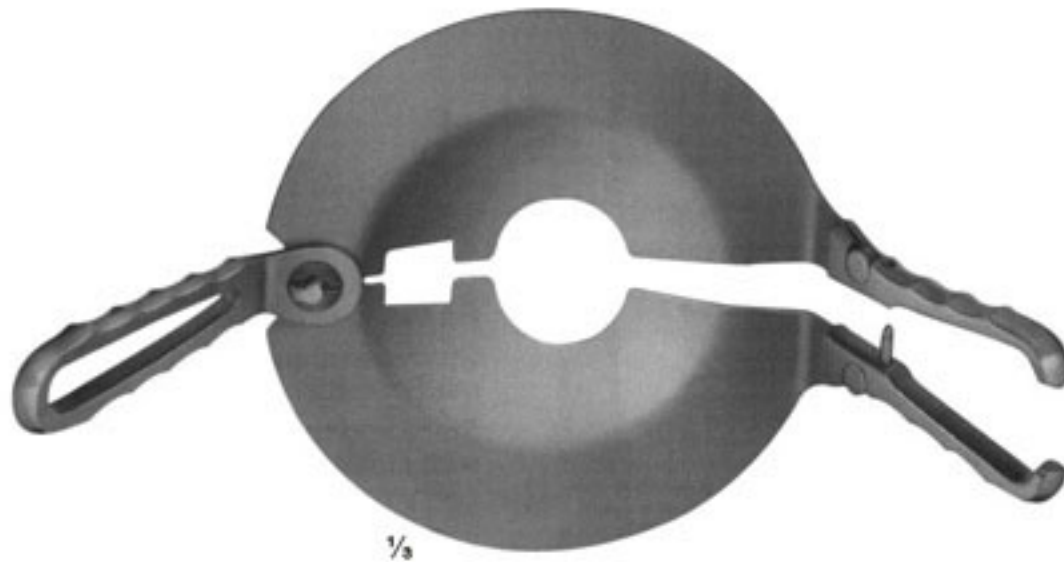

3/4

06-8006
PERCY
removeable handles

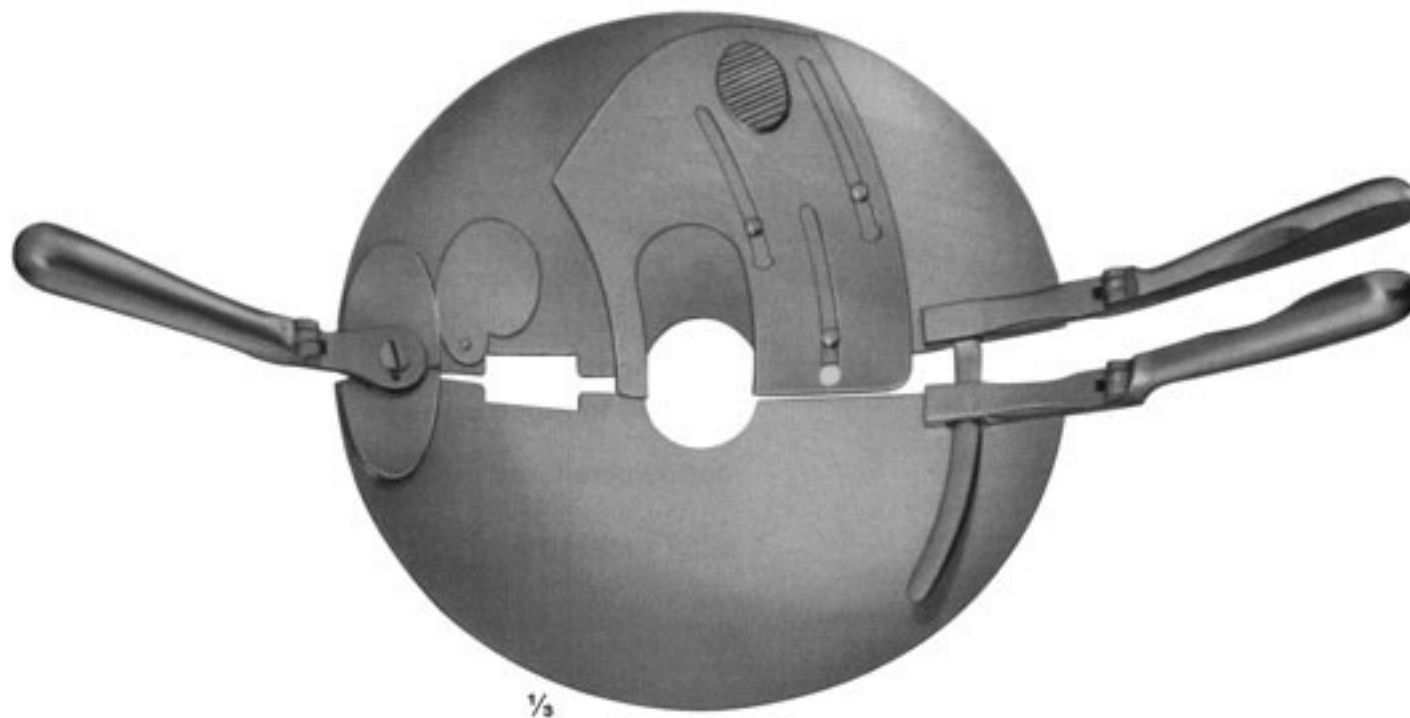

3/4

06-8007
PERCY
reversible handles



Amputation Saws



1/3

06-8008
CHARRIERE
 Length of blade
 215 mm
 complete with one saw
 blade each(**06-8009** and **06-8010**)
 350 mm

Spare saw blades, carbon steel
06-8009 12 mm
06-8010 20 mm

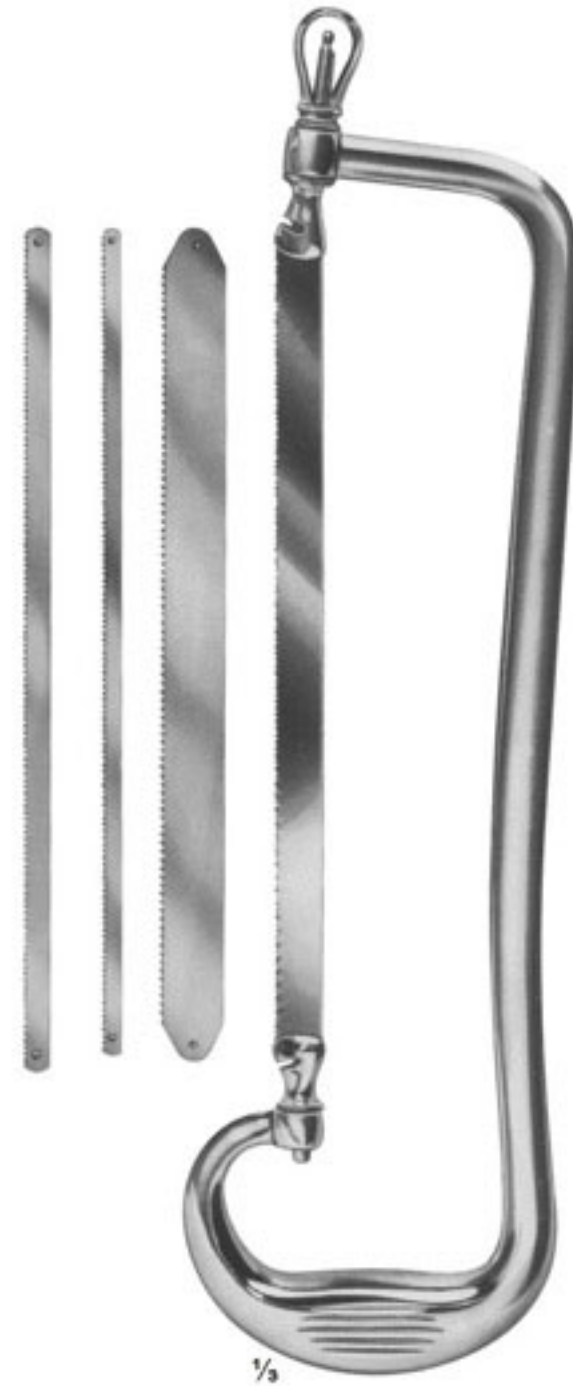

1/3

06-8011
RUST
 Length of blade
 235 mm
 complete with one saw
 blade each(**06-8013**, **06-8014**
 and 2 saw blades **06-8015**)
 390 mm
06-8012 Bow only

Spare saw blades, carbon steel
06-8013 6 mm
06-8014 8 mm
06-8015 12 mm
06-8016 20 mm



Amputation Saws

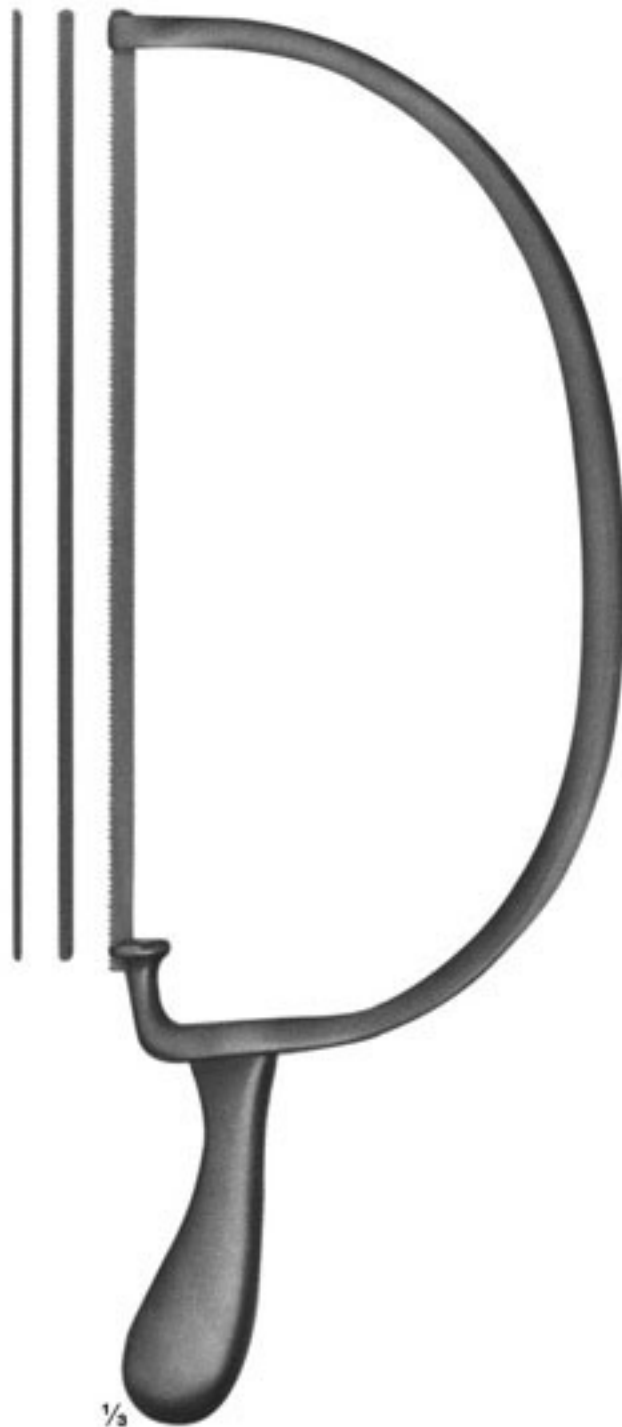

1/3

06-8017
BIER
Length of blade
270 mm
complete with one saw
blade each(06-8018, 06-8019 and 06-8020)
420 mm

Spare saw blades, carbon steel
06-8018 4 mm
06-8019 6 mm
06-8020 8 mm

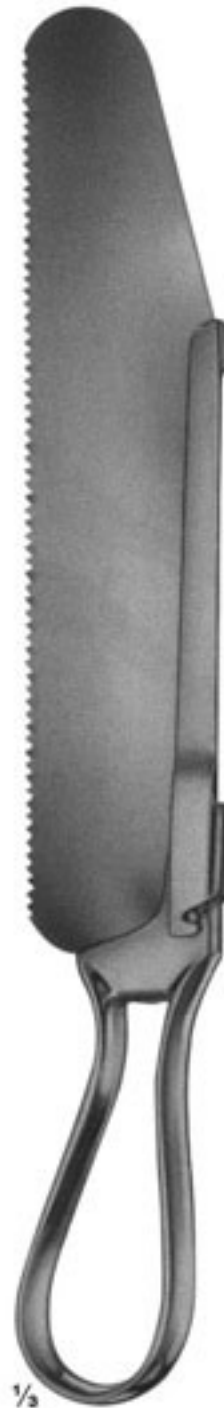

1/3

06-8021
CHARRIERE
Length of blade
180 mm
Spare saw blade,
carbon steel (06-8022)
270 mm

06-8023
CHARRIERE
Length of blade
240 mm
Spare saw blade,
carbon steel(06-8024)
340 mm



1/3

06-8025
SATTERLEE
Length of blade
200 mm
Spare saw blade,
carbon steel(06-8026)
200 mm



1/3

06-8027
LANGENBECK
Length of blade
115 mm
Metacarpal saw
235 mm



Wire Saws And Conductor



06-8028 - 06-8031
OLIVECRONA
06-8028 300 mm
06-8029 400 mm
06-8030 500 mm
06-8031 700 mm



06-8032 - 06-8035
GIGLI
06-8032 300 mm
06-8033 400 mm
06-8034 500 mm
fine, 6 wires twisted
06-8035 500mm
coarse, 4 wires twisted



06-8036
GIGLI
Handle
1/4



06-8037
LEBSCHE
Conductor for
wire saws, malleable
250 mm
1/2



Elevators and Bone Levers

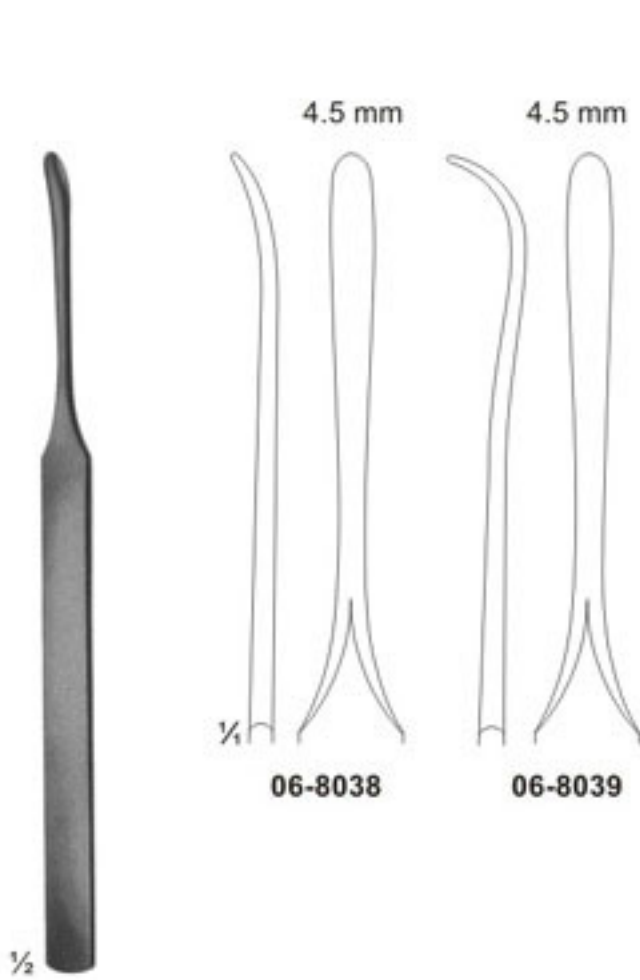

06-8038 - 06-8039
KOENIG
155 mm



06-8040
WILLIGER
165 mm

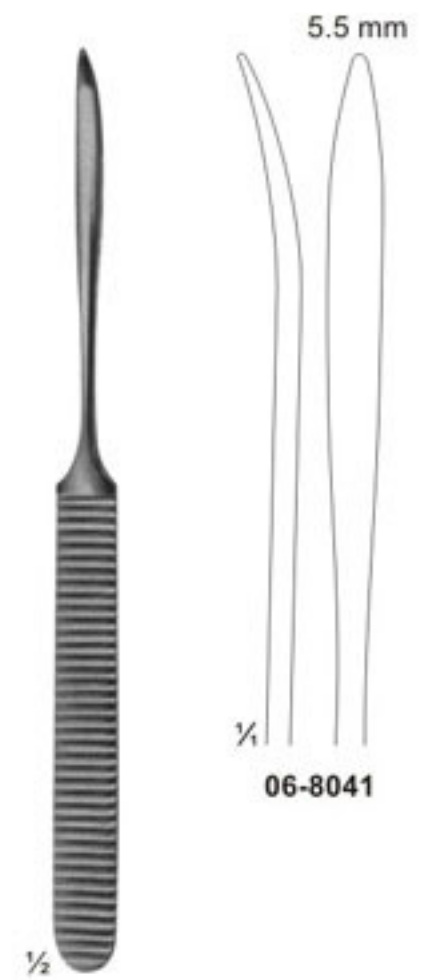

06-8041
WILLIGER
170 mm

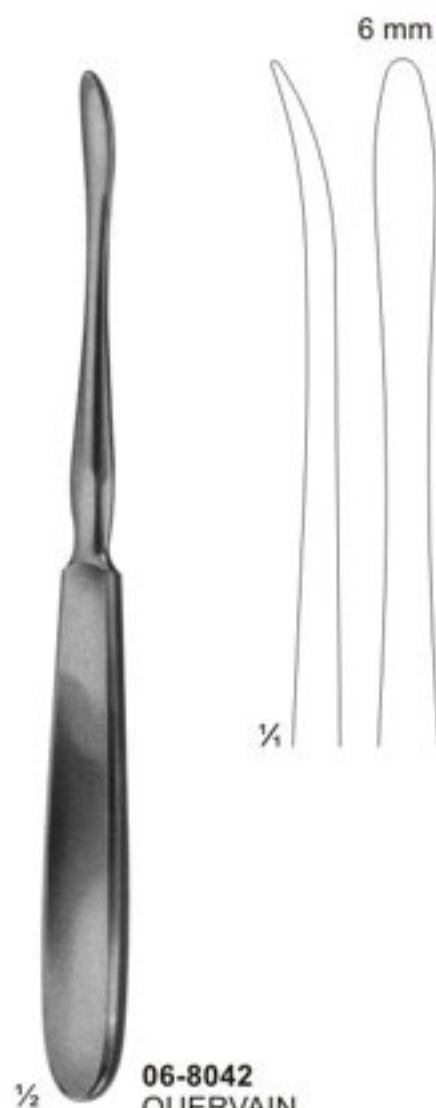

06-8042
QUERVAIN
195 mm

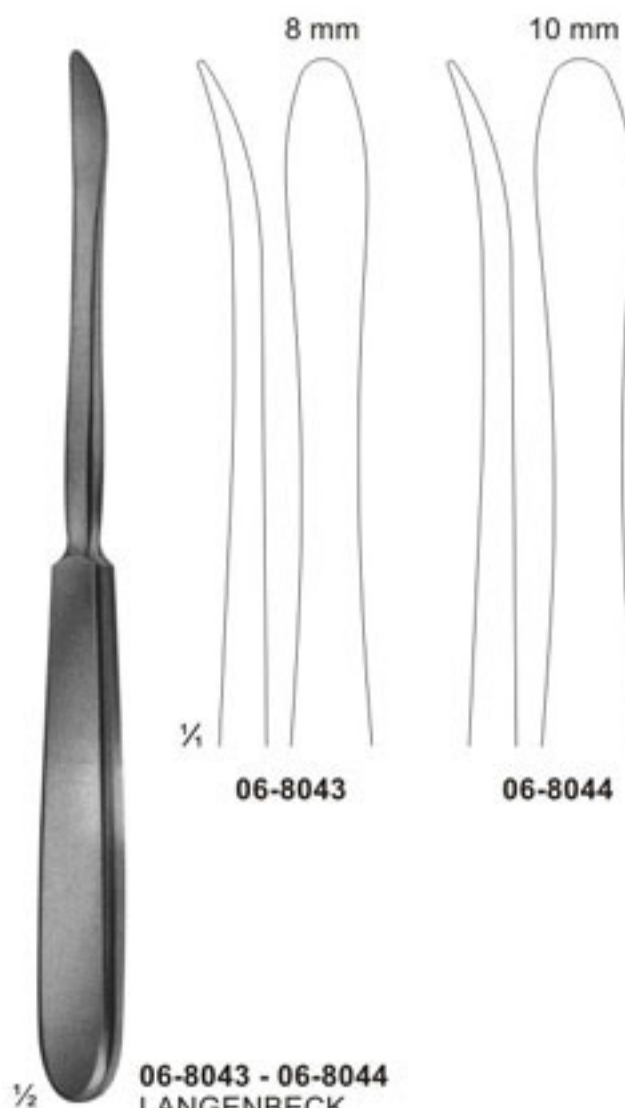

06-8043 - 06-8044
LANGENBECK
195 mm

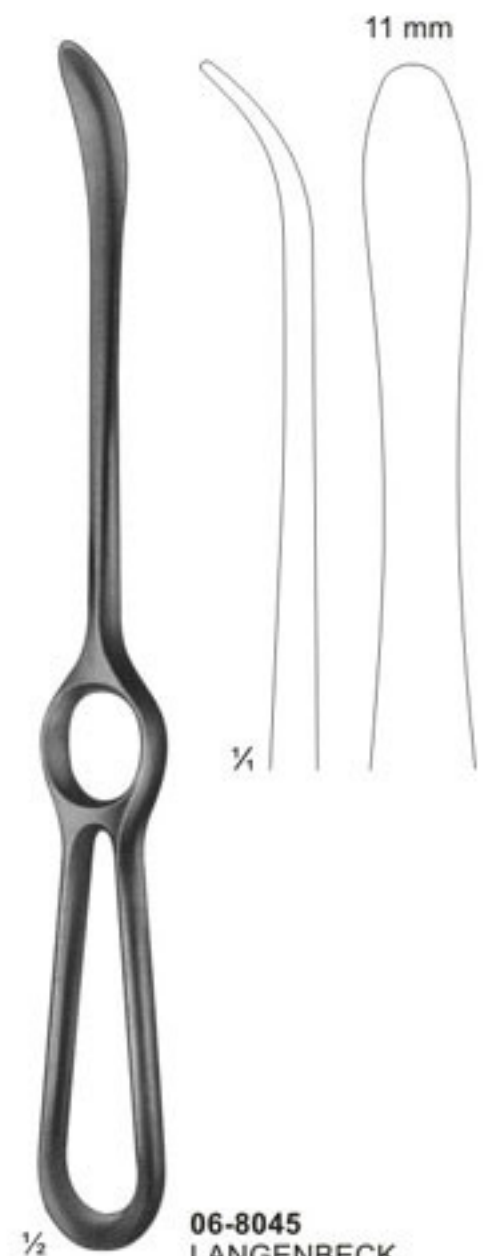

06-8045
LANGENBECK
230mm



Bone Levers

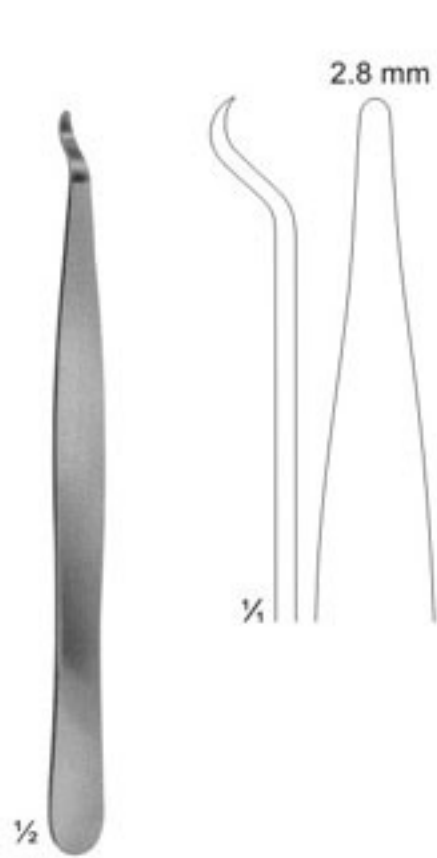

06-8046
140mm

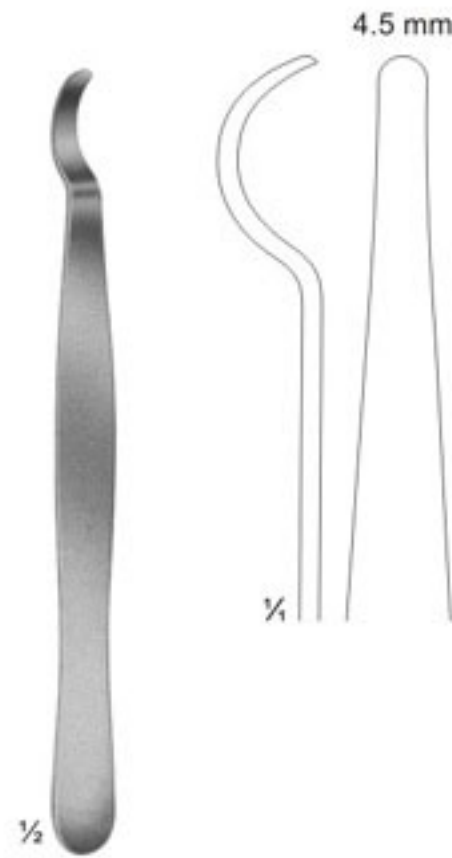

06-8047
150mm

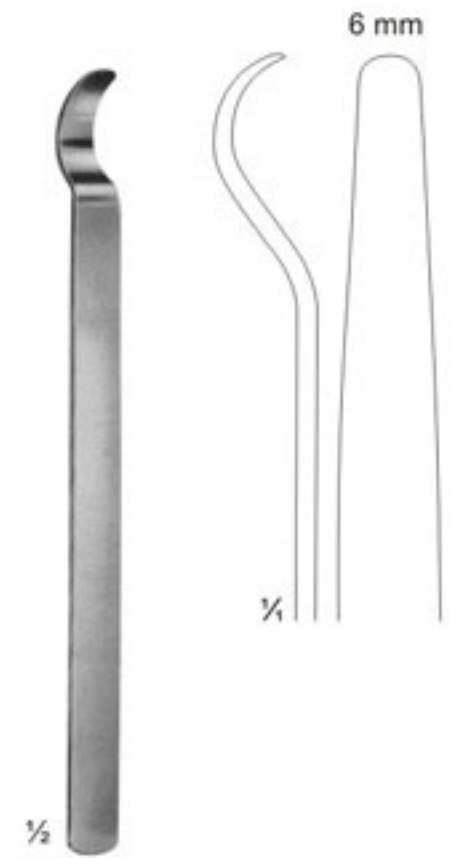

06-8048
150mm

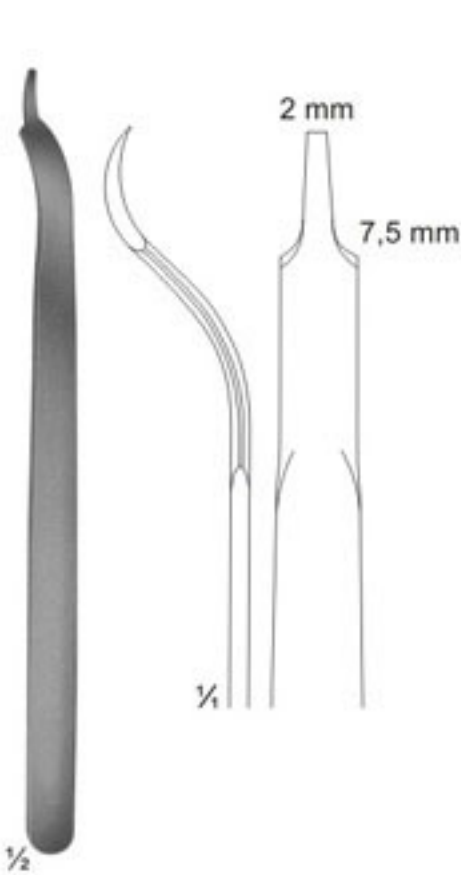

06-8049
BUCK-GRAMCKO
150mm



06-8050
160mm



06-8051
160mm

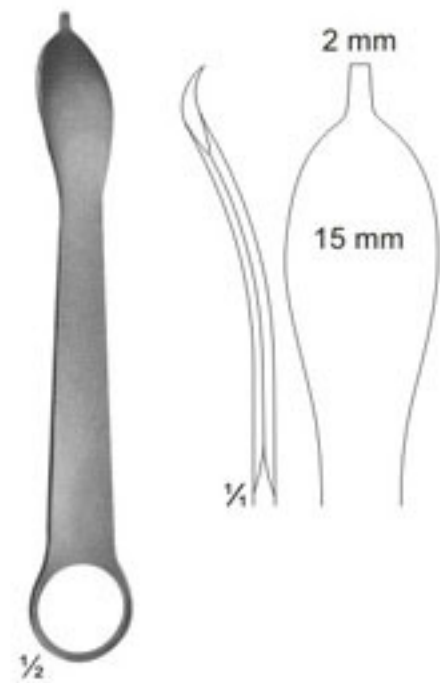

06-8052
125mm



Bone Levers



06-8053
LANE TRETHOWAN
215mm

06-8054
LANE
255mm

06-8055
LANGE-HOHMANN
250mm

06-8056 - 06-8057
LANGE-HOHMANN
modif
06-8056 265mm
06-8057 280mm



Bone Levers



06-8058
WAGNER
220 mm

06-8059
220 mm

06-8060
240 mm

06-8061
240 mm



Bone Levers

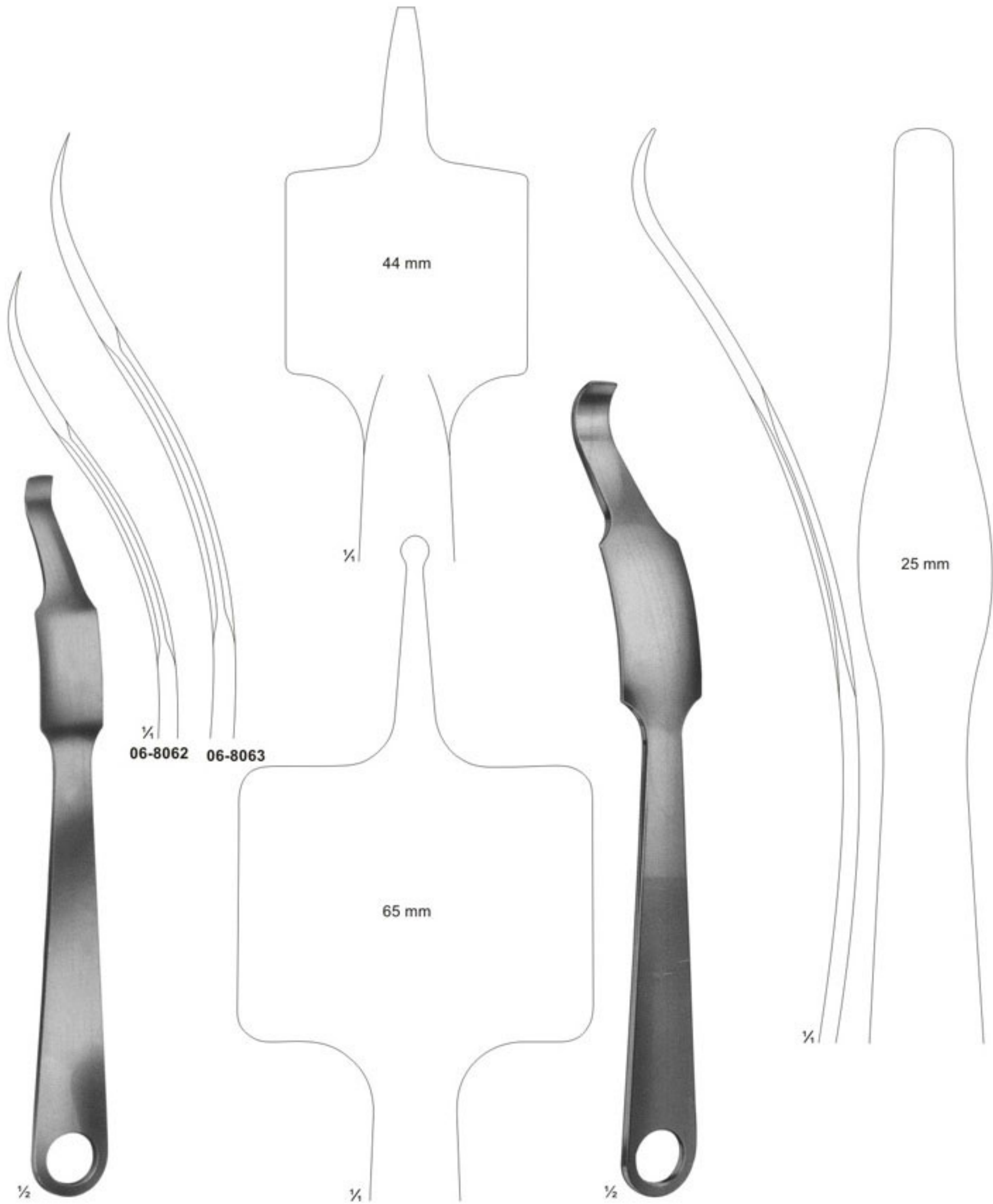

06-8062 06-8063

06-8062 - 06-8063
VERBRUGGE-MULLER
06-8062 240 mm
06-8063 255 mm

06-8064
260 mm



Bone Levers

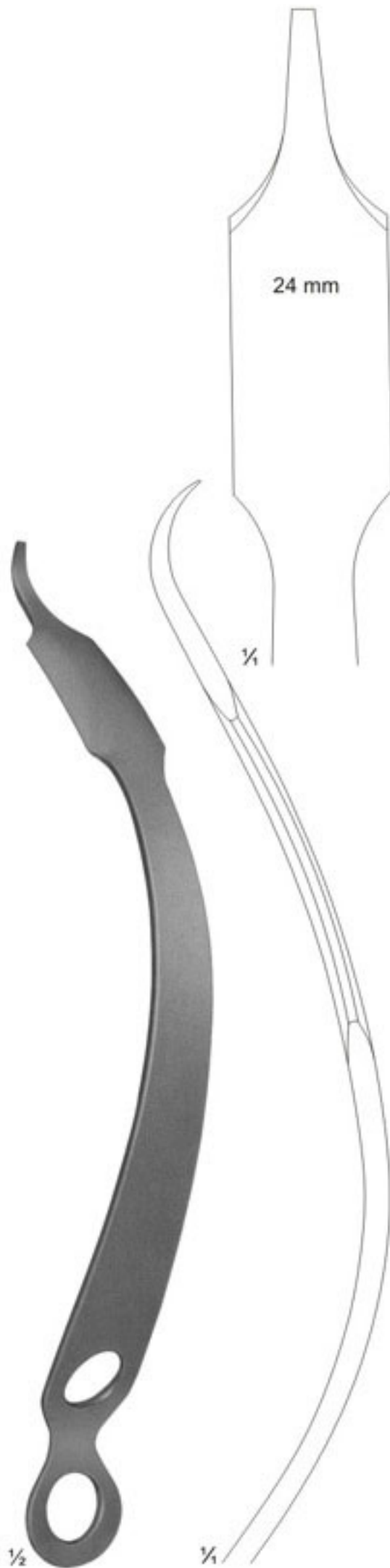

06-8065
HOHMANN-ALDINGER
270 mm



06-8066
SCHUMACHER mod. WAGNER
345 mm

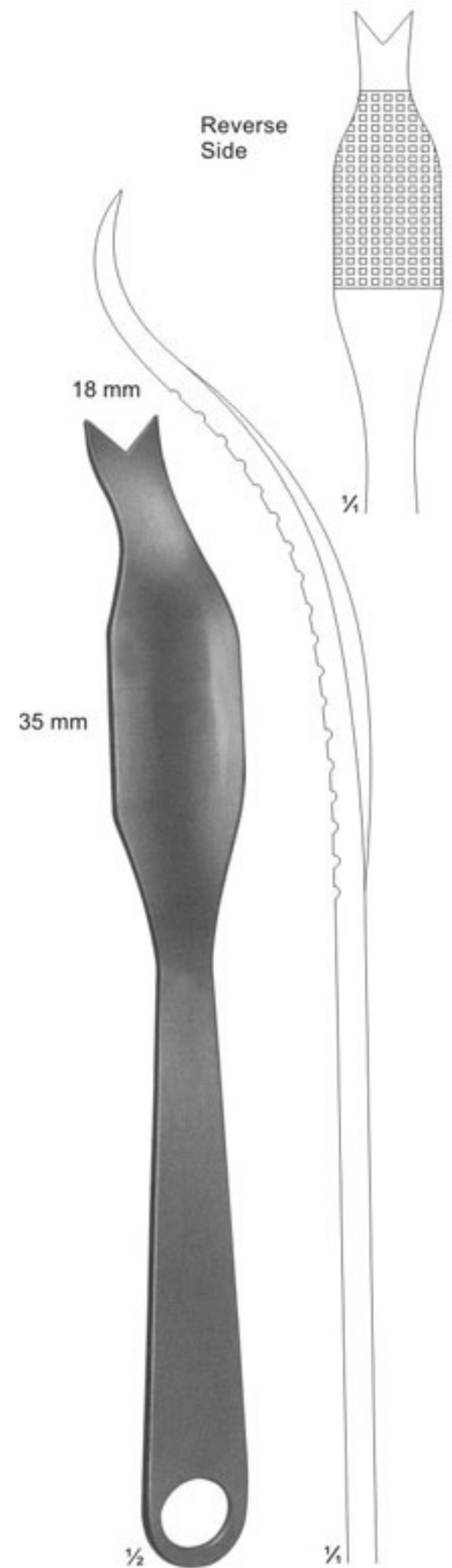

06-8067
SCHUMACHER
290 mm



Special Bone Levers

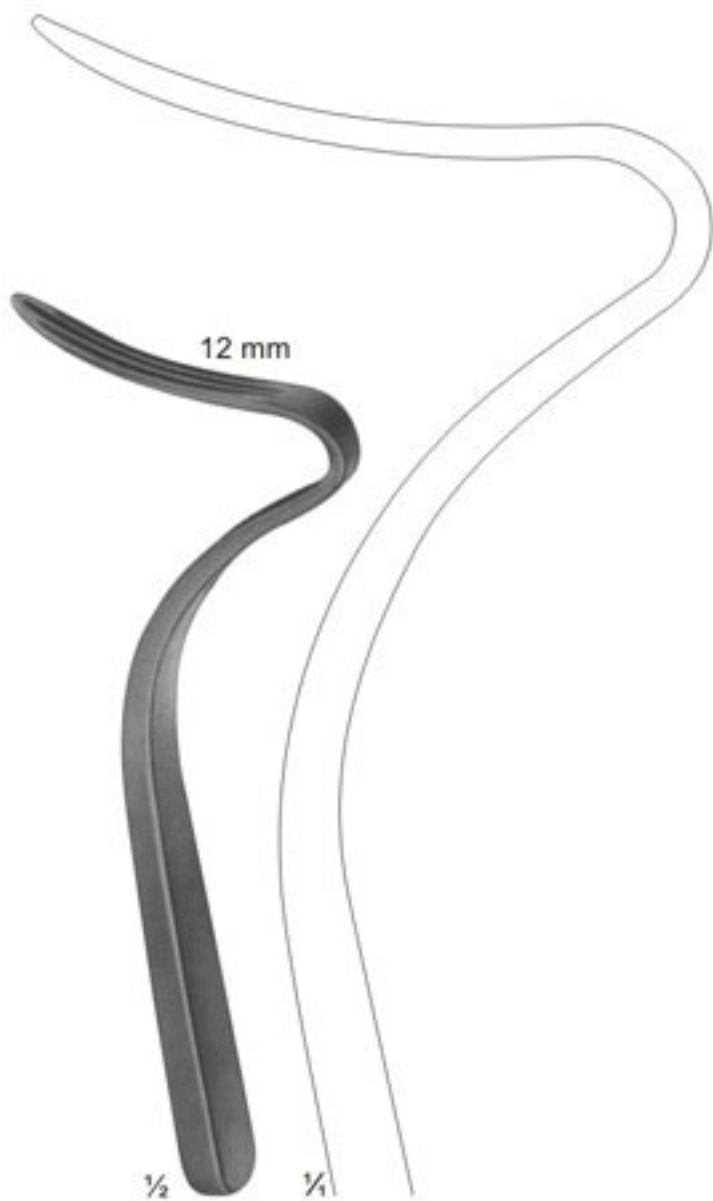

06-8068
TAGER
Bone lever for
angle joint operations
175 mm

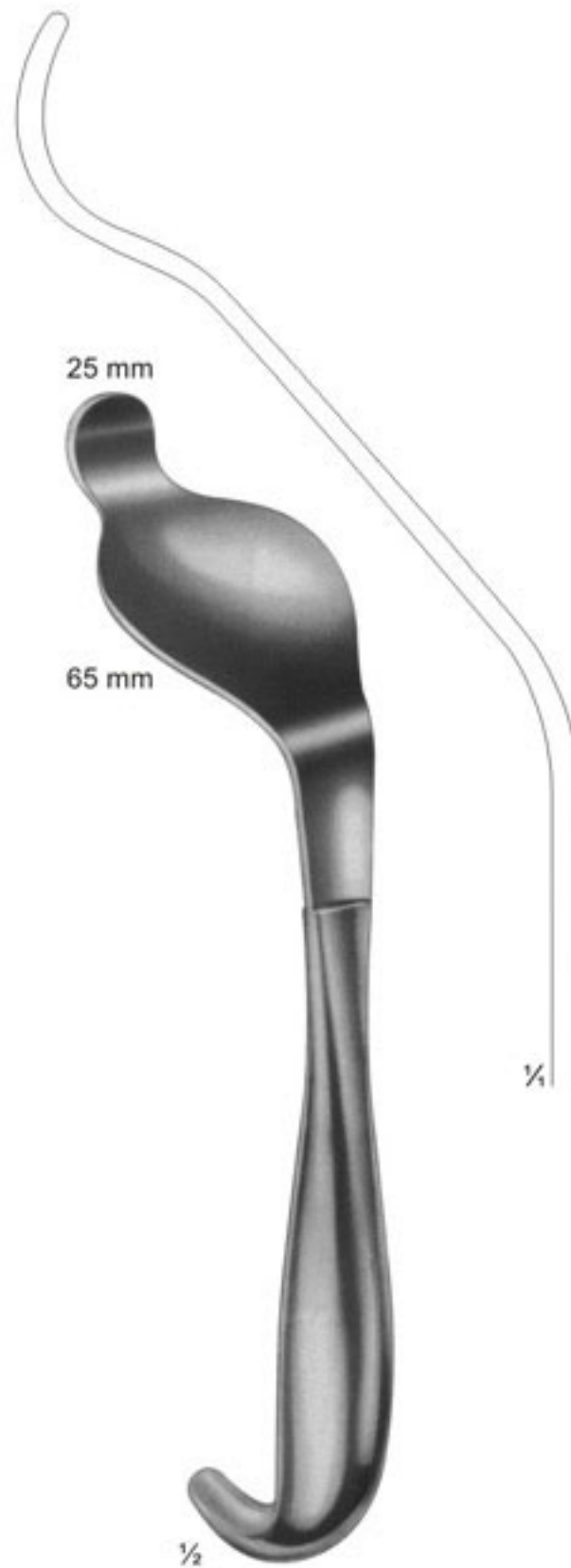

06-8069
BENNETT
235 mm

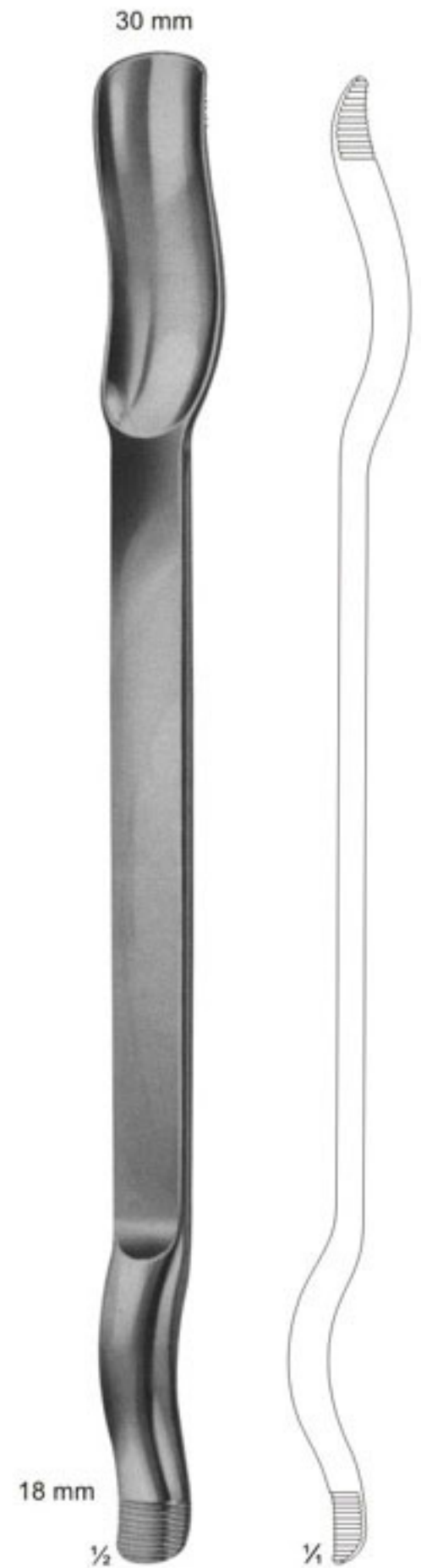

06-8070
MURPHY-LANE
Luxation lever
340 mm



Raspatories

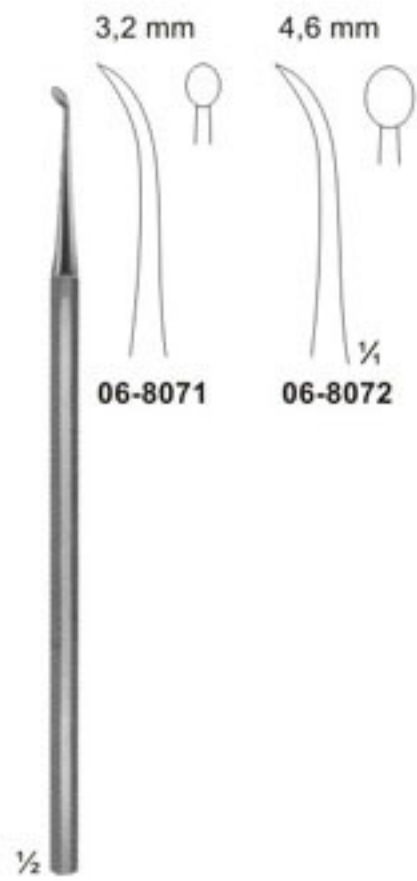

06-8071 - 06-8072
PARTSCH
150 mm

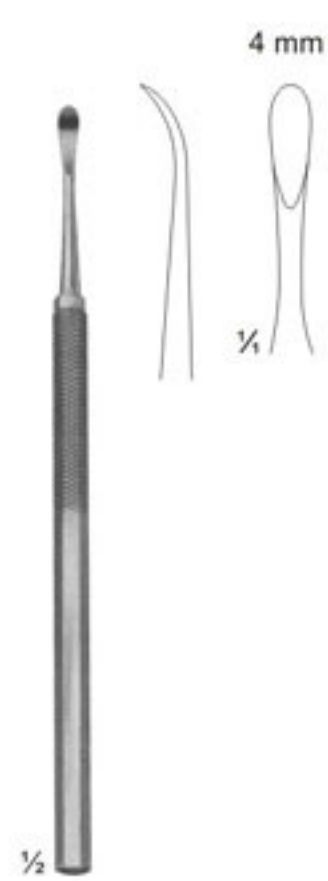

06-8073
PARTSCH mod. LANGE
145 mm

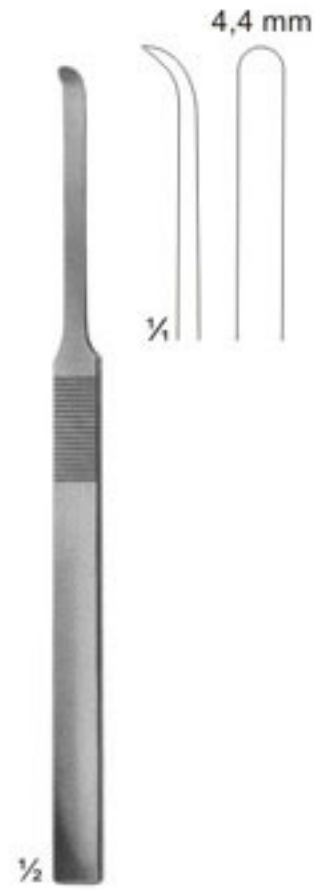

06-8074
MC KENTY
155 mm

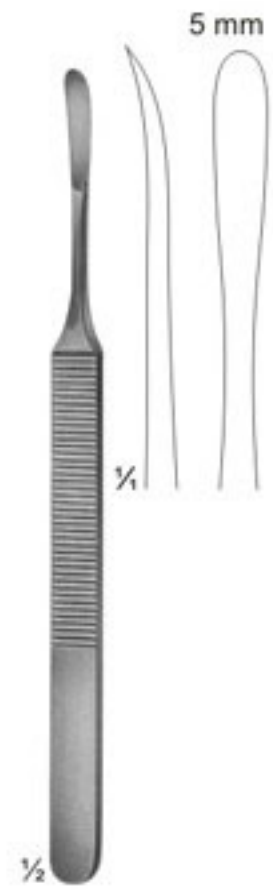

06-8075
KOENIG
155 mm

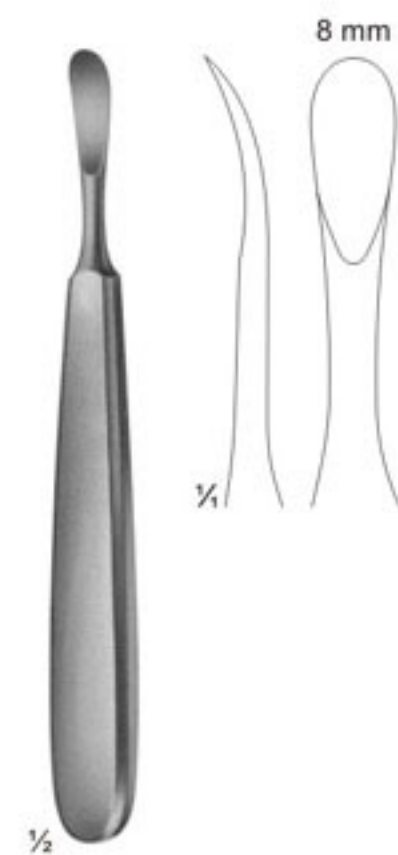

06-8076
TRELAT
150 mm

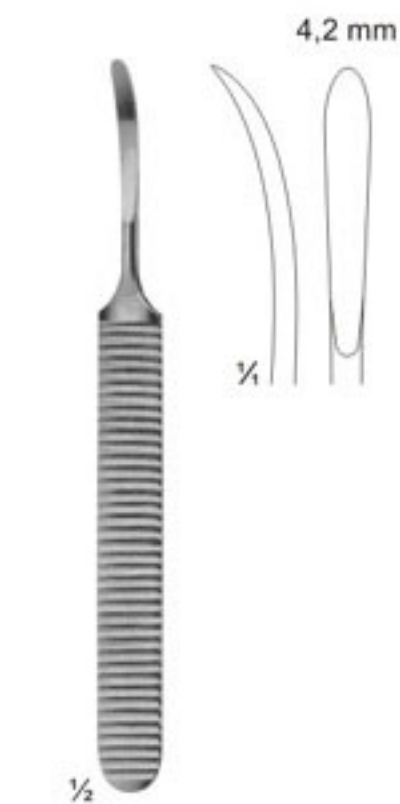

06-8077
WILLIGER
140 mm



06-8078
WILLIGER
160 mm

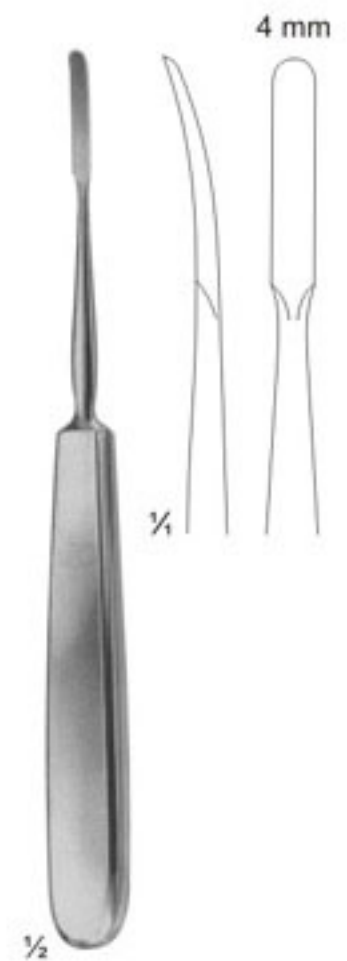

06-8079
JOSEPH
170 mm



Raspatories

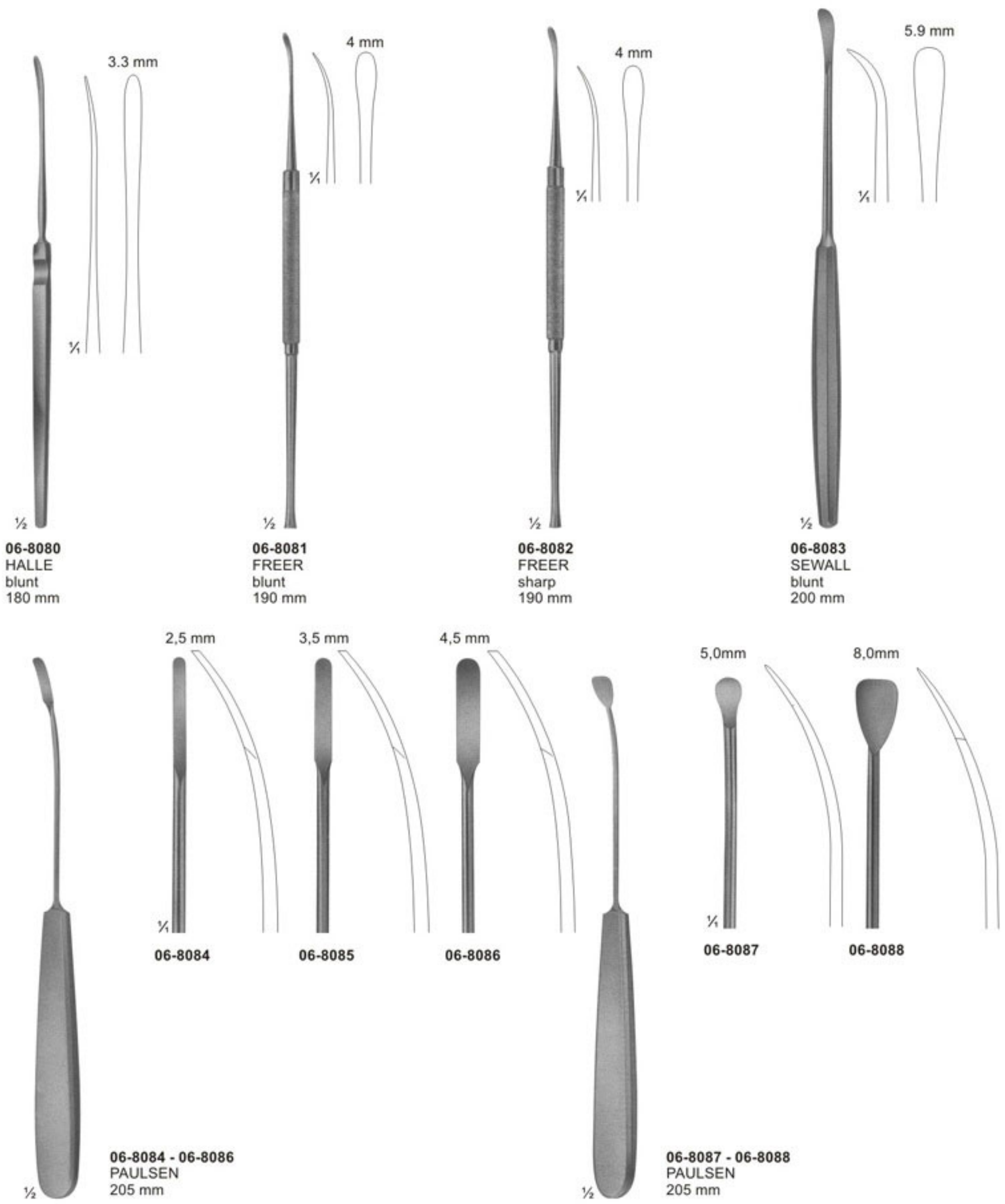

06-8084 - 06-8086
PAULSEN
205 mm

06-8087 - 06-8088
PAULSEN
205 mm



Raspatories

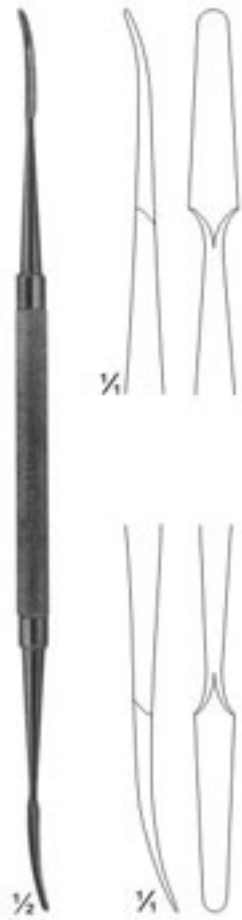

06-8089
KILLIAN
sharp/blunt
185 mm

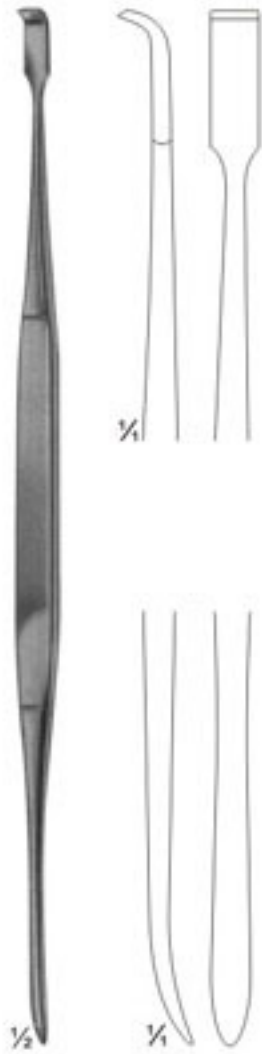

06-8090
HOWARTH
sharp/blunt
215 mm



06-8091
KILLIAN
sharp/blunt
185 mm

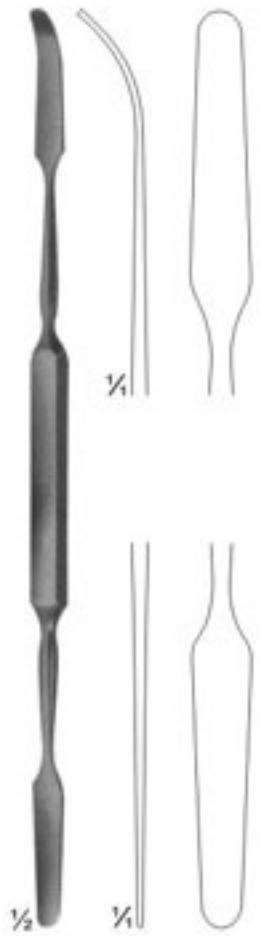

06-8092
MAC DONALD
blunt/blunt
185 mm

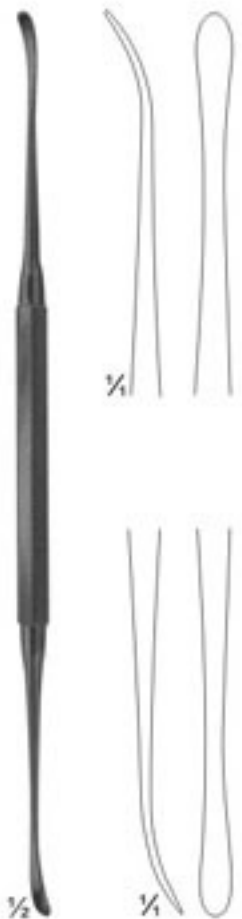

06-8093
FREER
sharp/blunt
185 mm

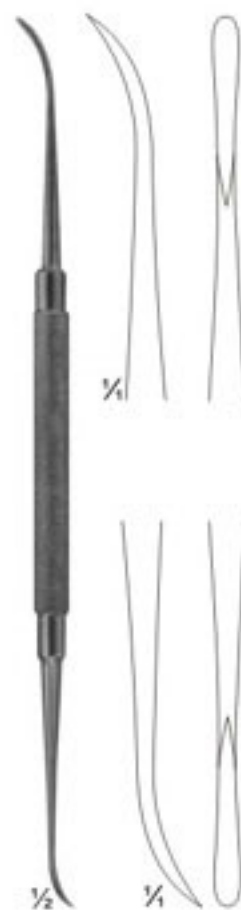

06-8094
FREER-YASARGIL
sharp/sharp
185 mm

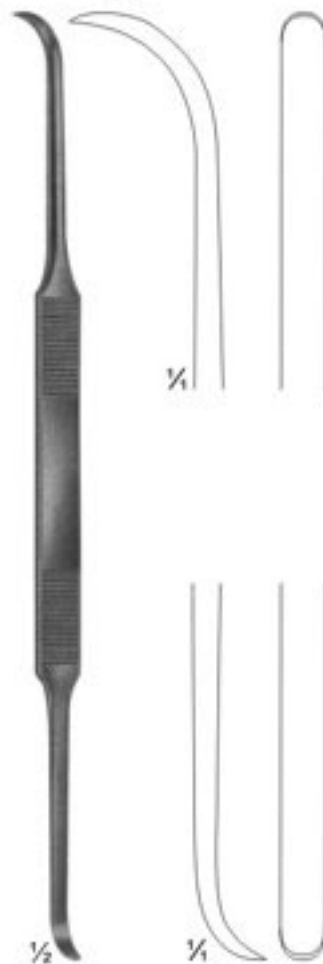

06-8095
COTTLE
sharp/sharp
200 mm



06-8096
MEAD
sharp/sharp
165 mm



06-8097
MOLT
sharp/sharp
180 mm



Raspatories

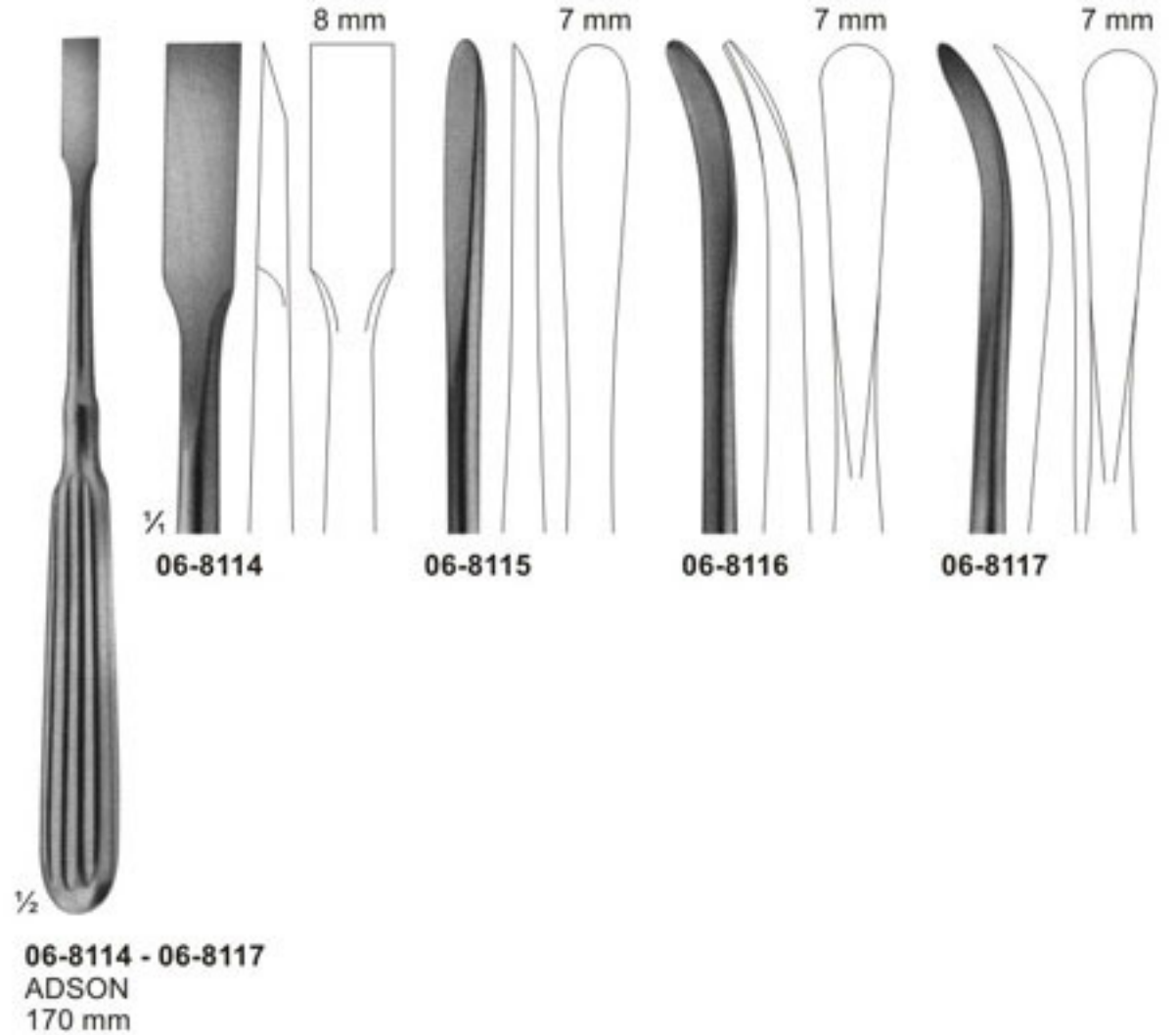
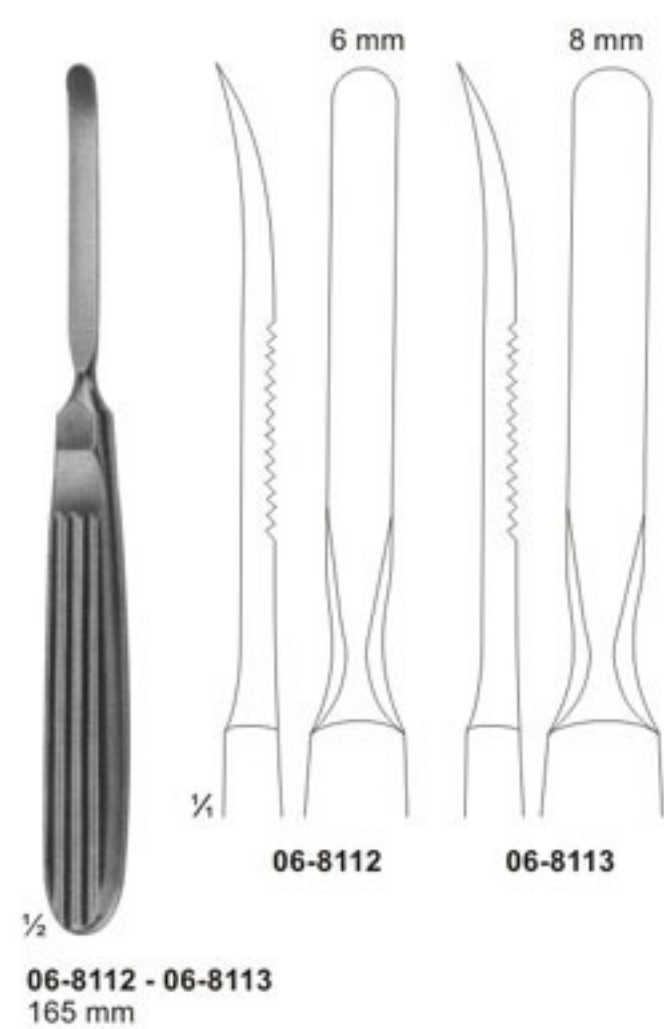
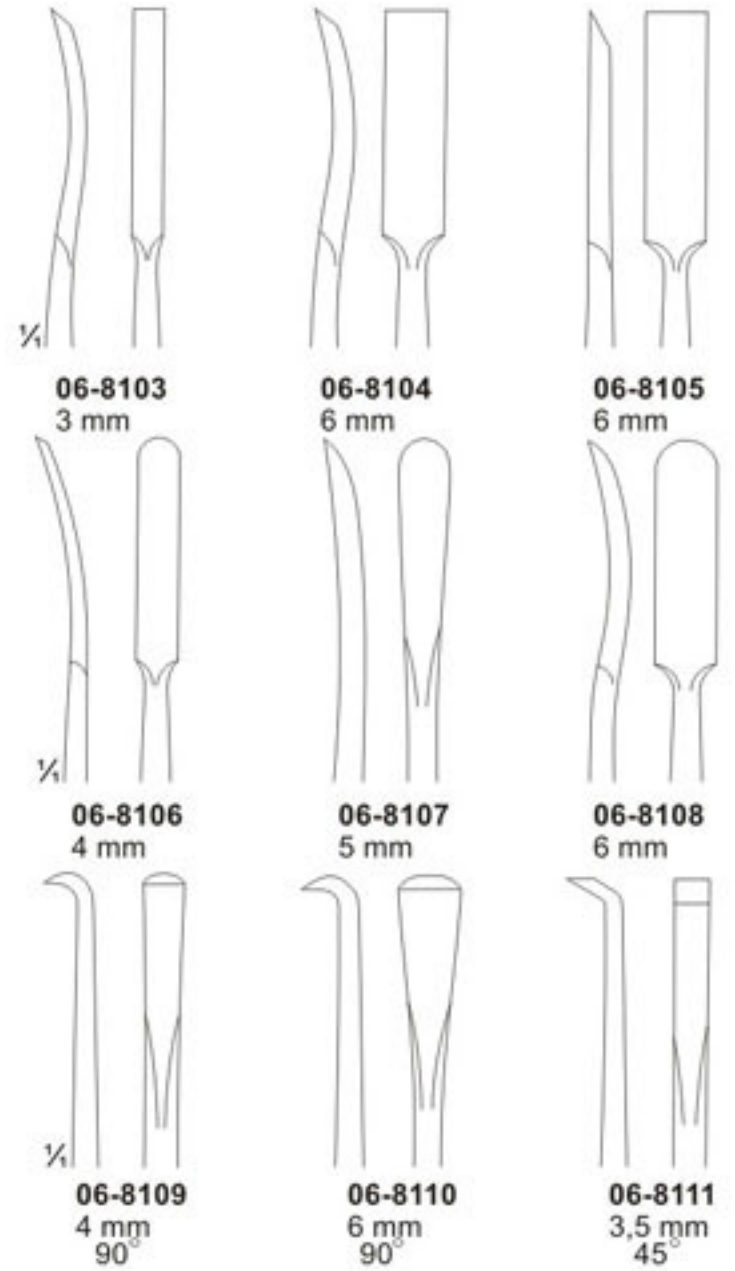
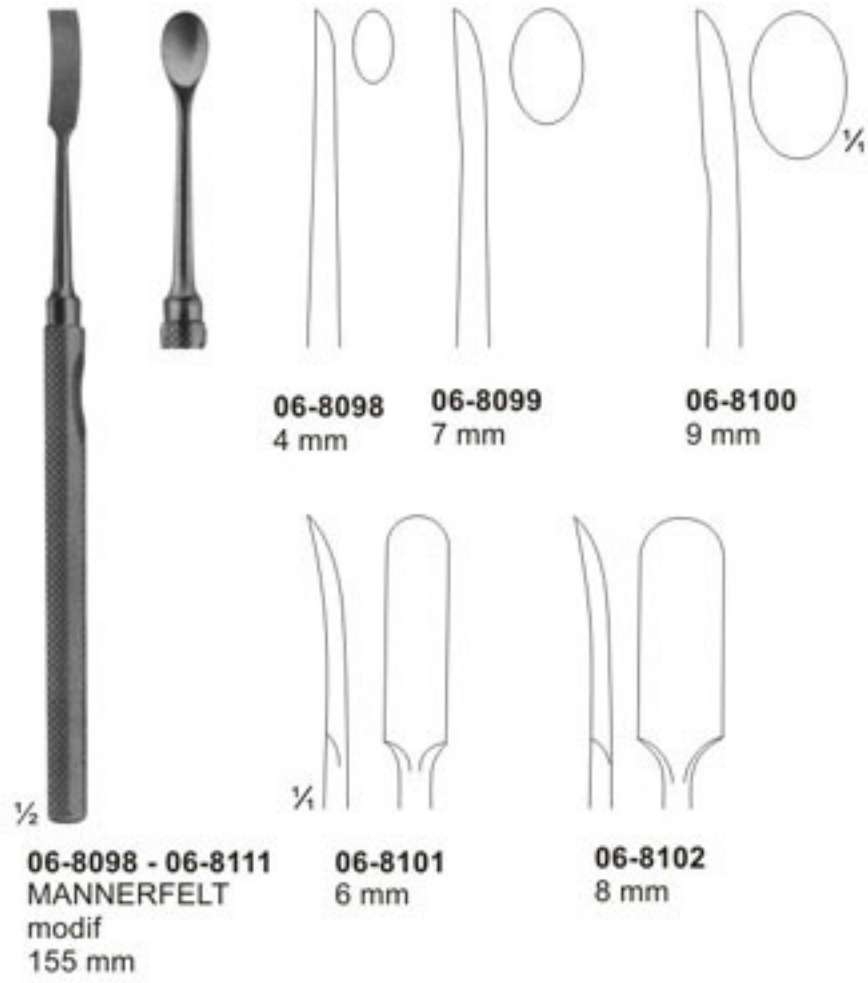



Raspatories

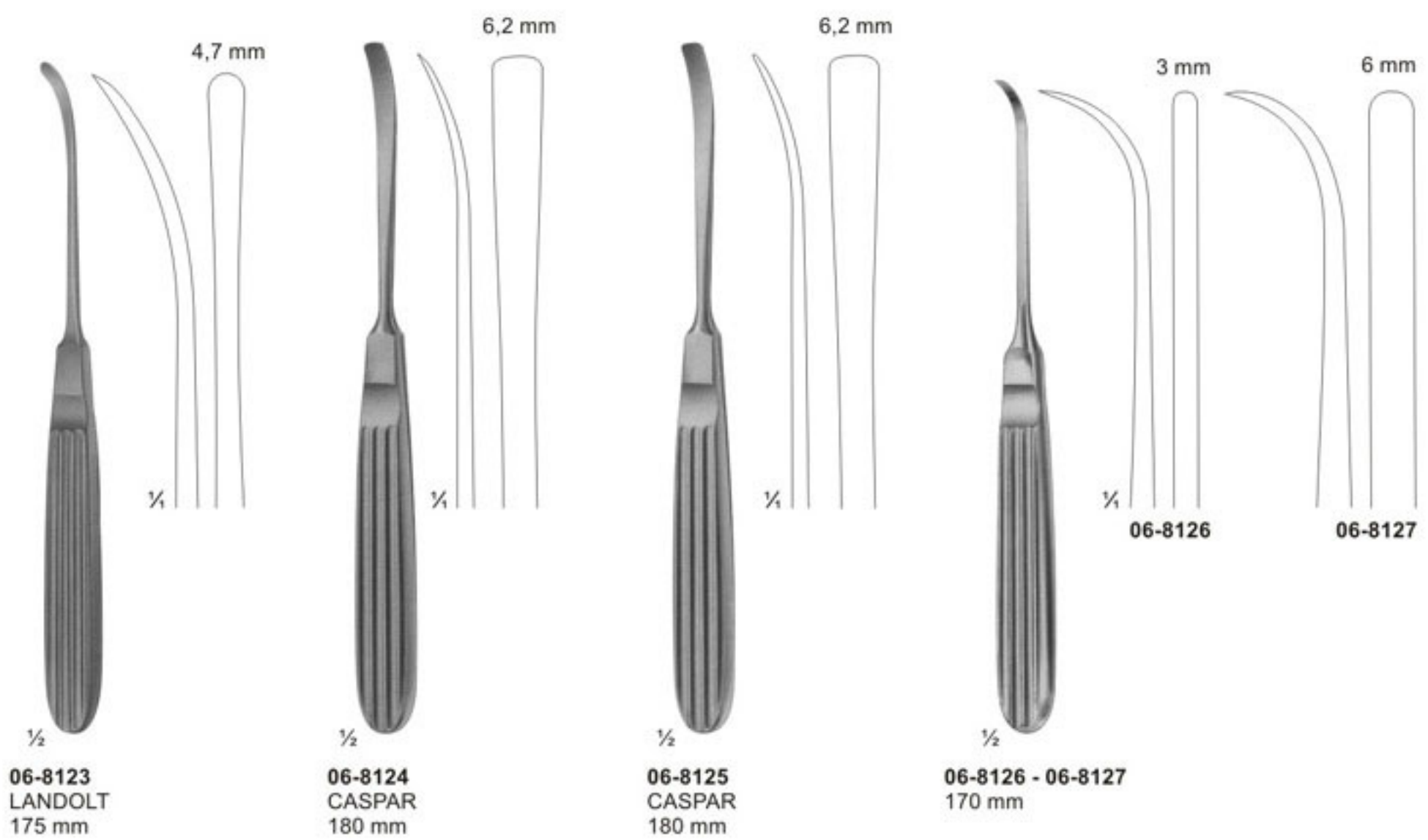
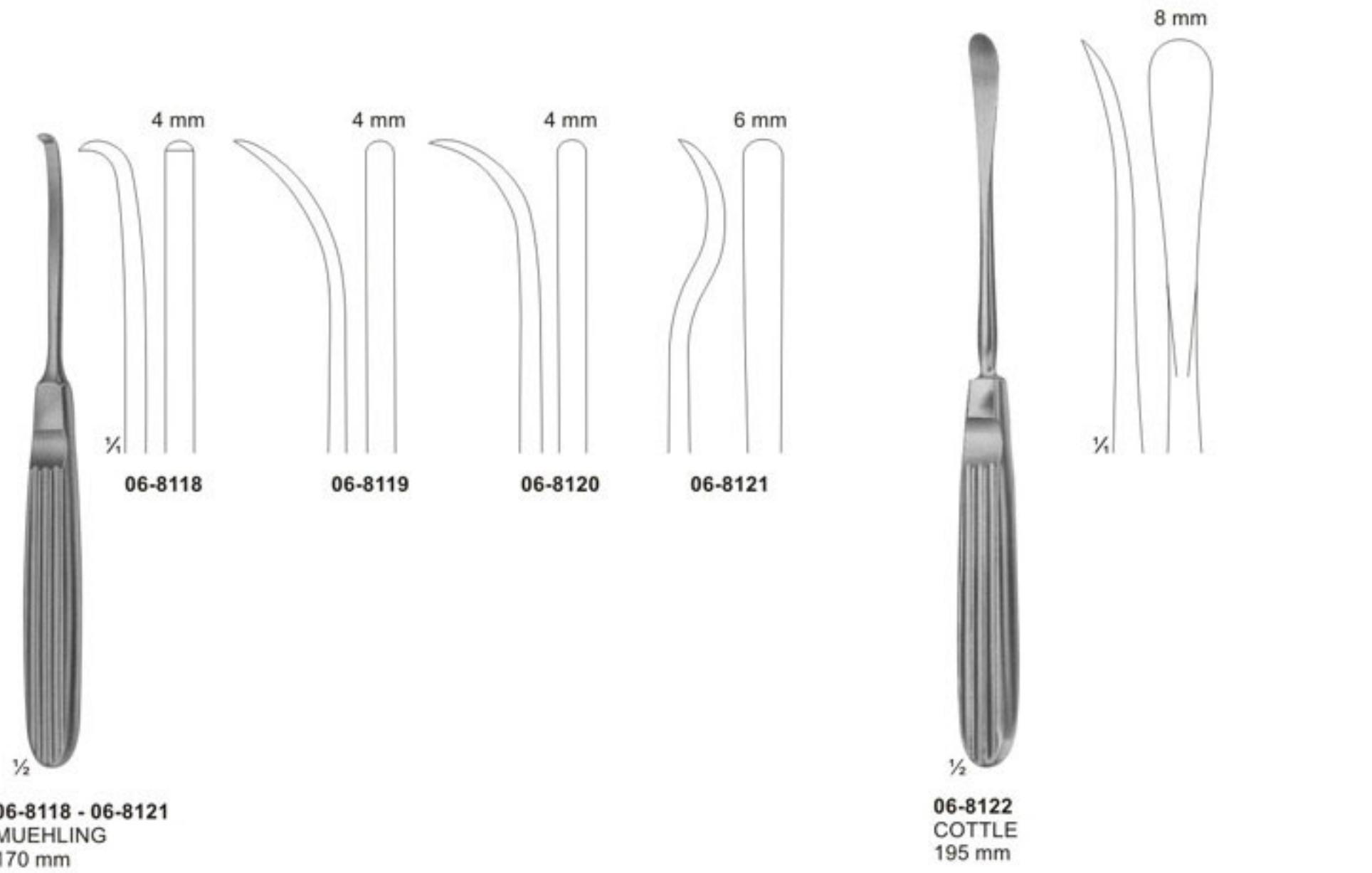



Raspatories

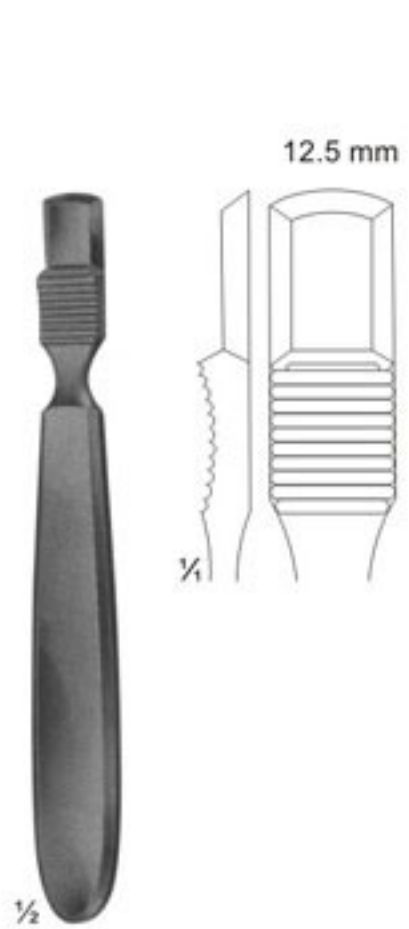

06-8128
FARABEUF
140 mm

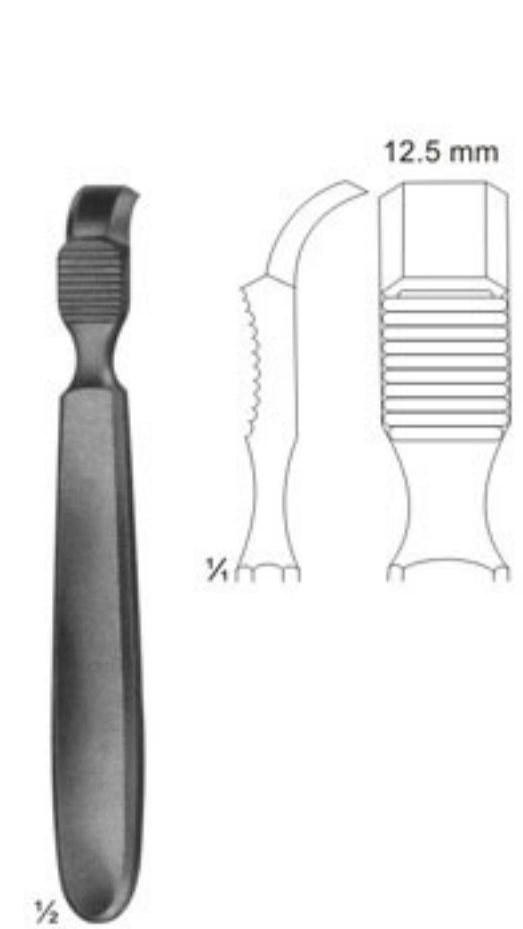

06-8129
FARABEUF
140 mm

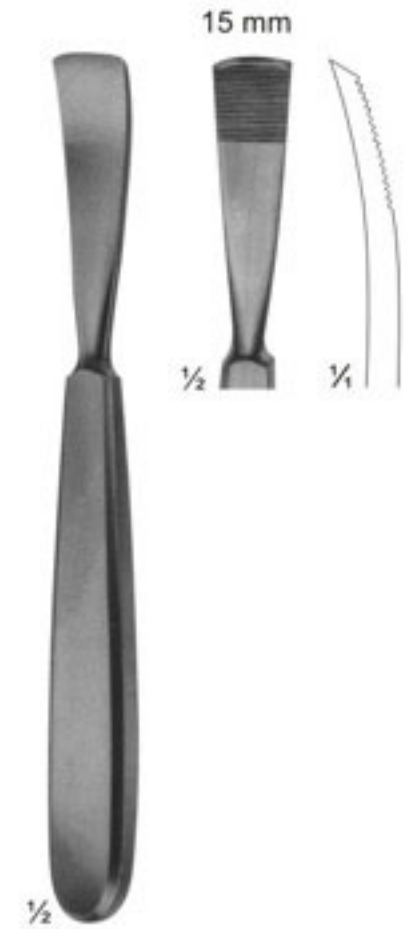

06-8130
JANSEN
165 mm

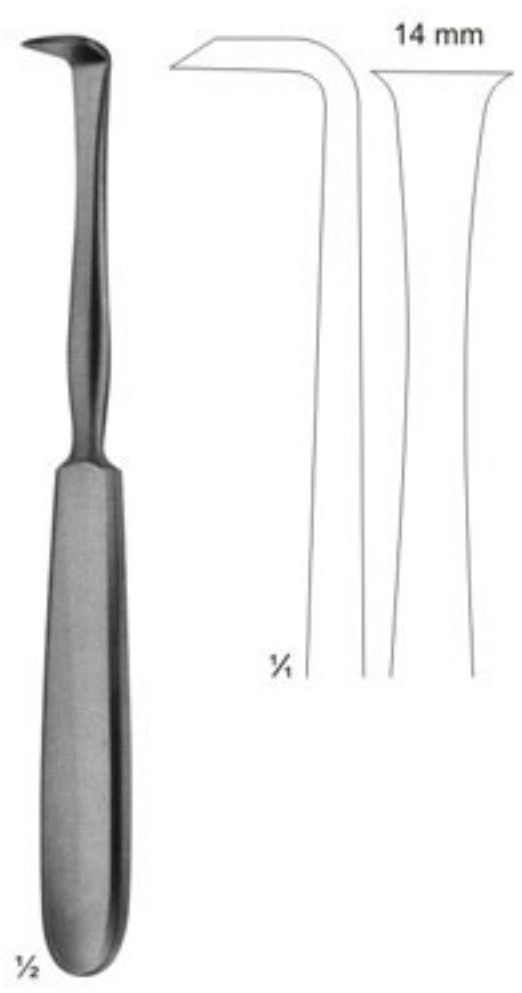

06-8131
LANGENBECK
180 mm

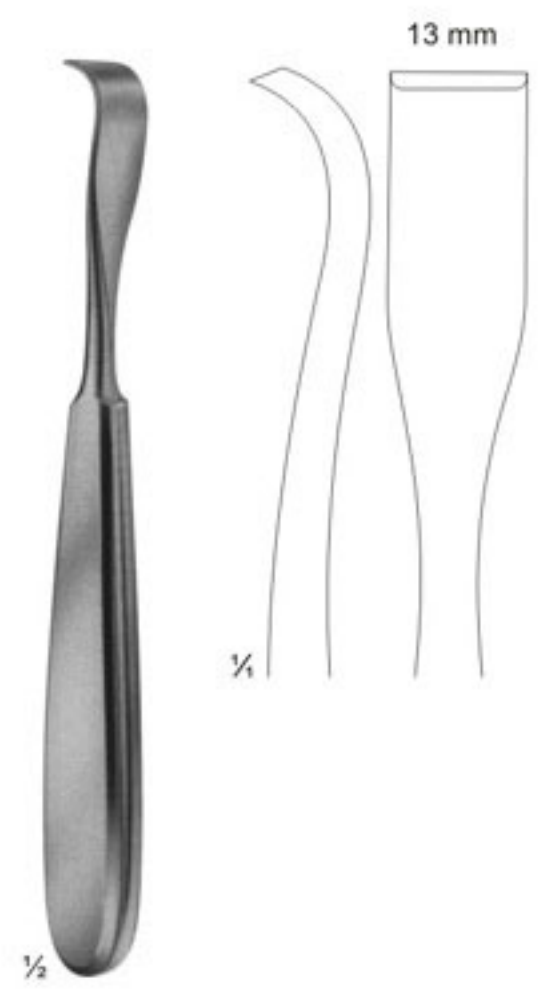

06-8132
SCHNEIDER
175 mm

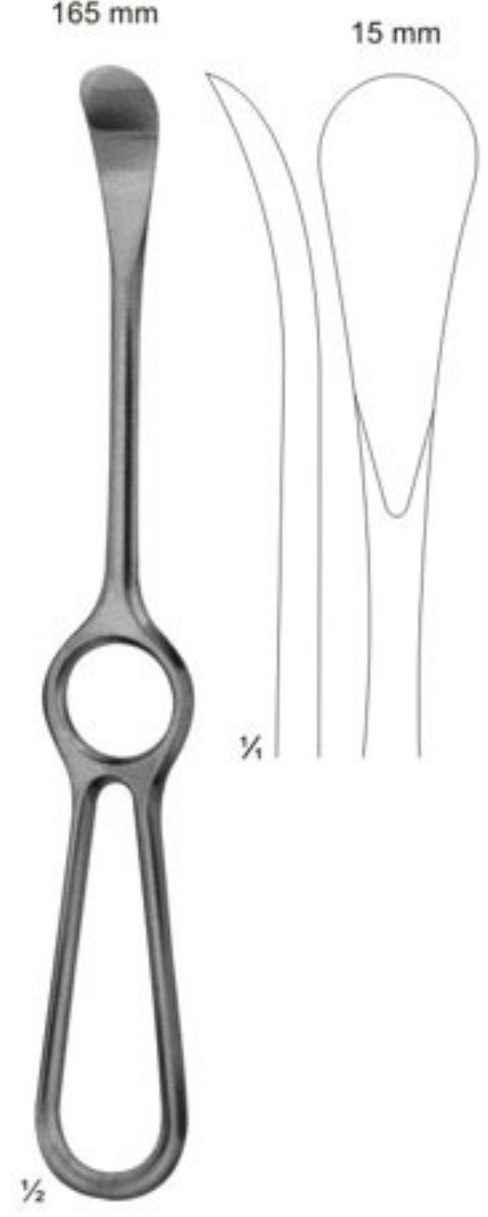

06-8133
SEDILLOT
215 mm



Raspatories

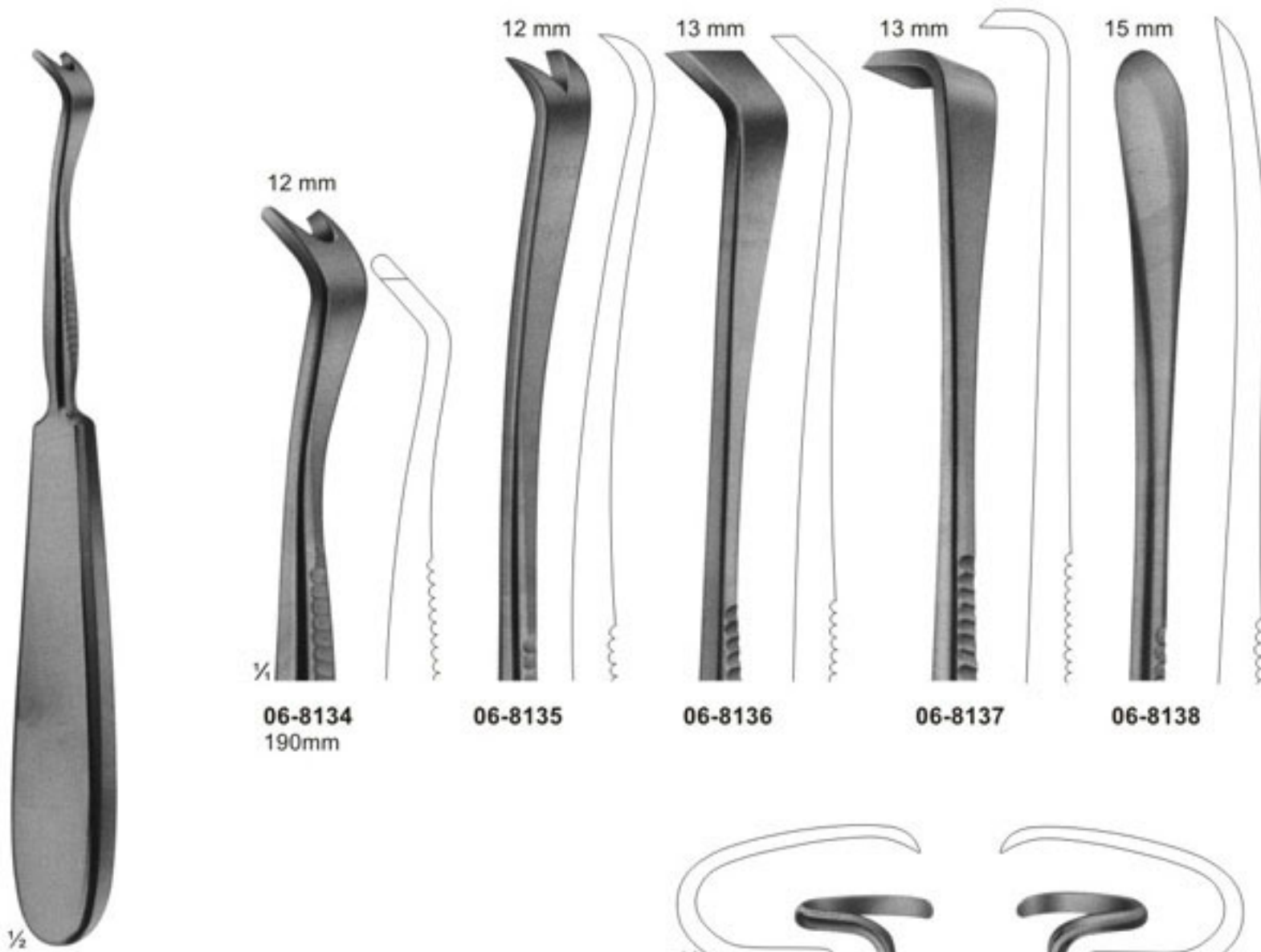

06-8134 - 06-8138
SEMB
230 mm



06-8143

06-8144



06-8139 - 06-8140
DOYEN for children
06-8141 - 06-8142
for adults 175 mm

06-8143 - 06-8144
DOYEN
240 mm



Raspatories with HARTPRESS-handle

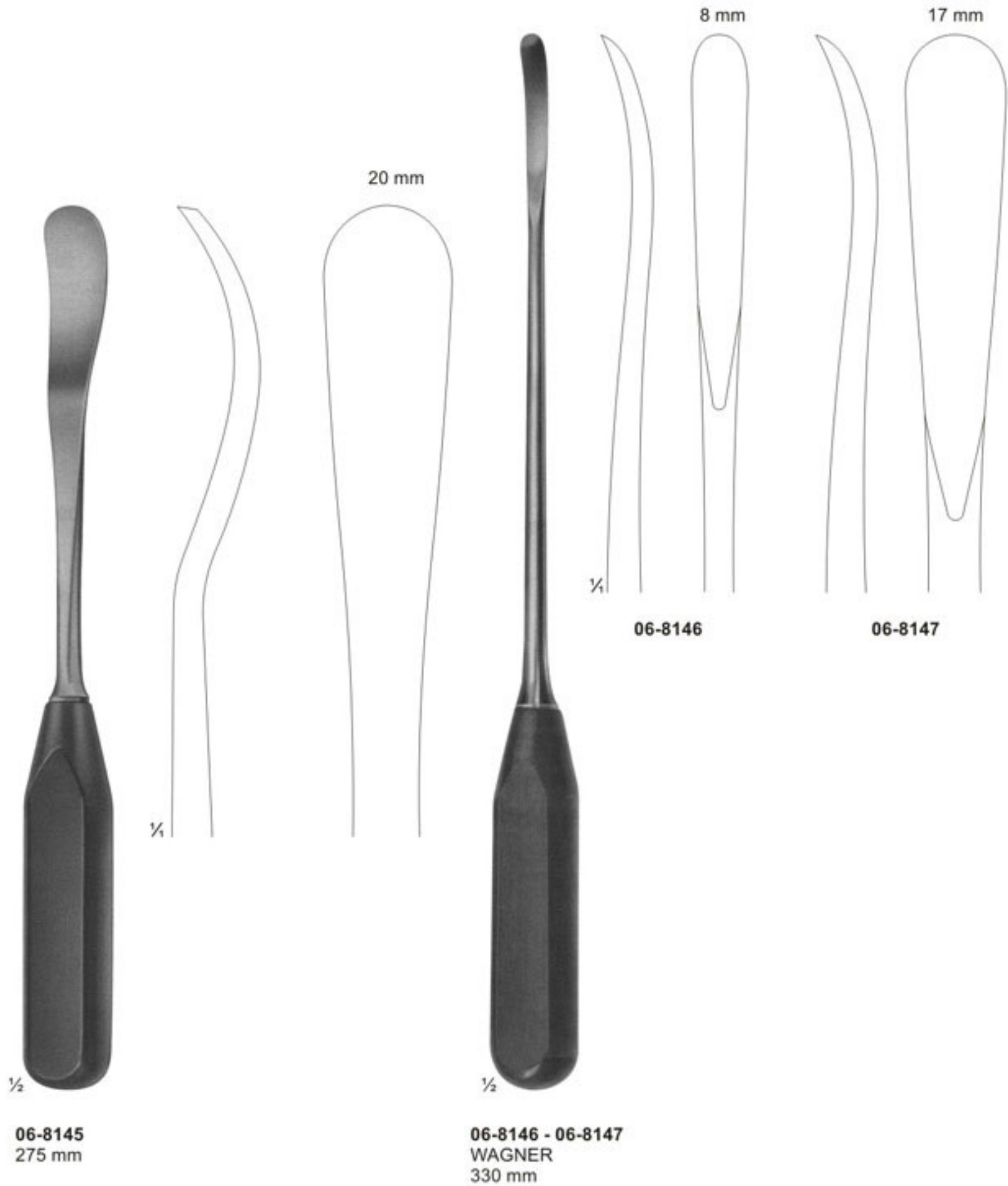



Bone File and Rasps

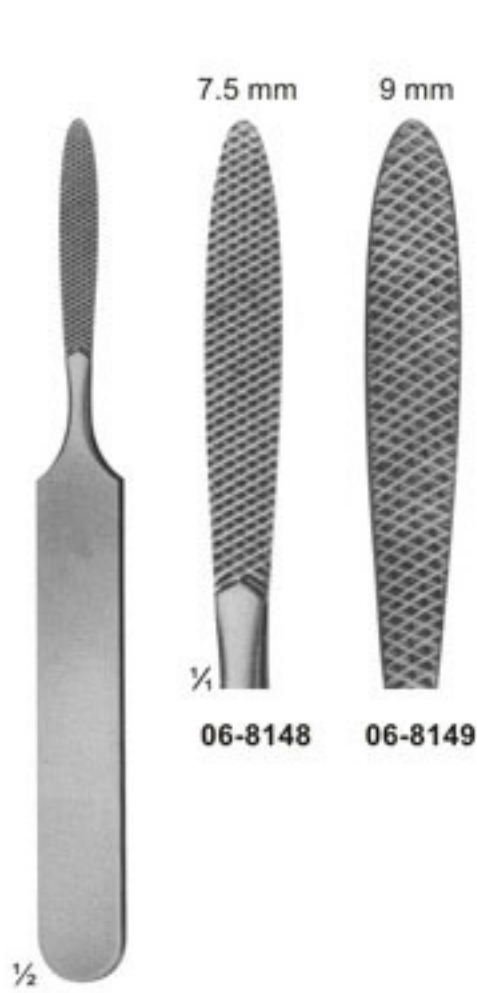

06-8148
JOSEPH
fine, chequered

06-8149
coarse, chequered
165 mm



06-8152
MALTZ
down stroke
180 mm



06-8153
AUFRICHT
up stroke
06-8154
down stroke
220 mm

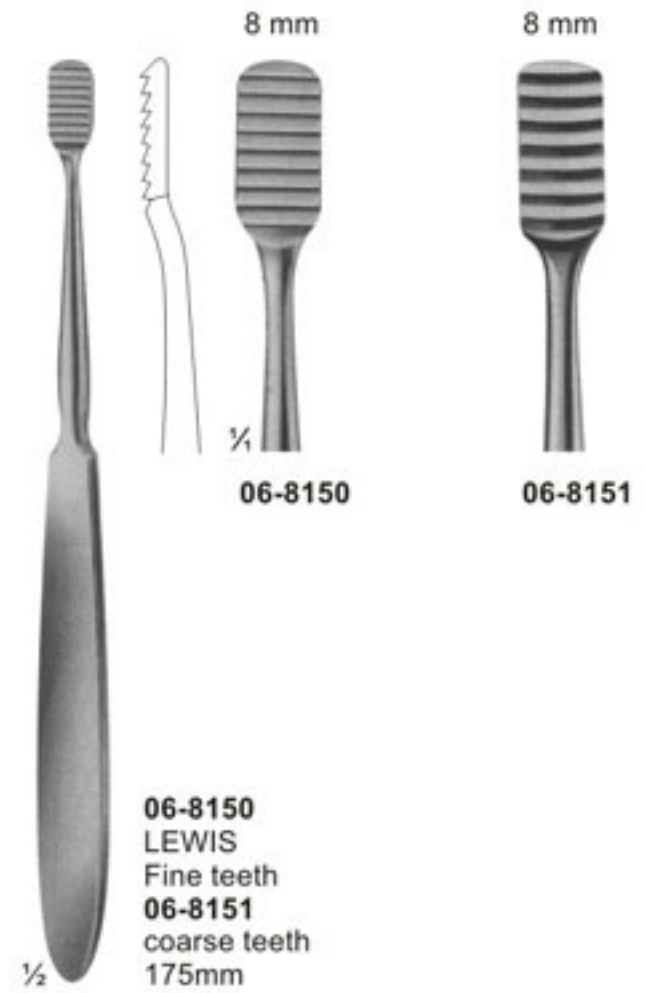
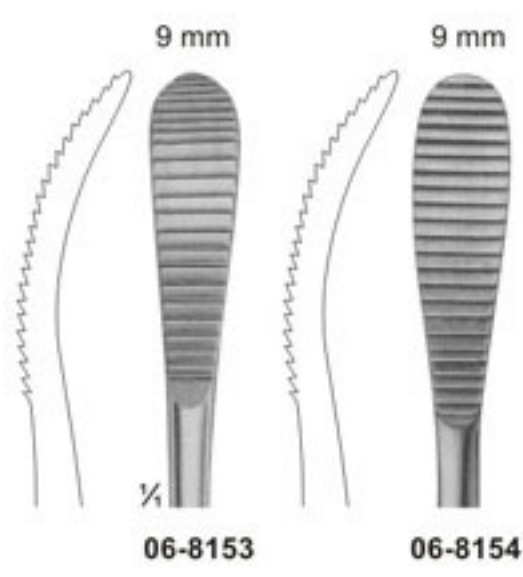

06-8150
LEWIS
Fine teeth
06-8151
coarse teeth
175mm



06-8155
GALLAHER
190 mm



Bone File and Rasps, Durogrip Rasps

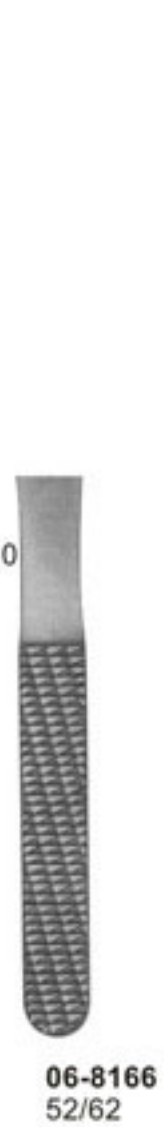
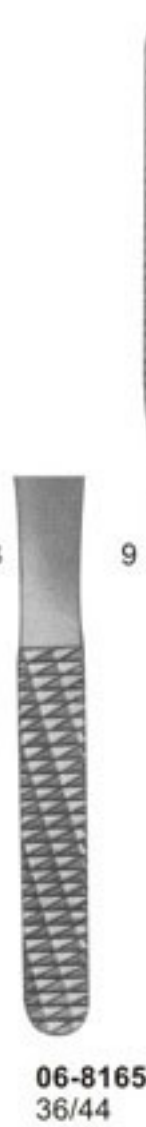
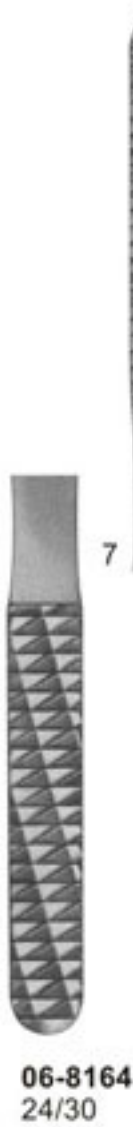
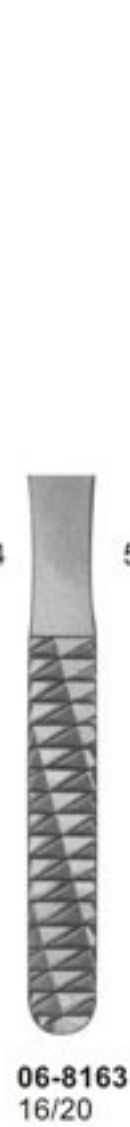
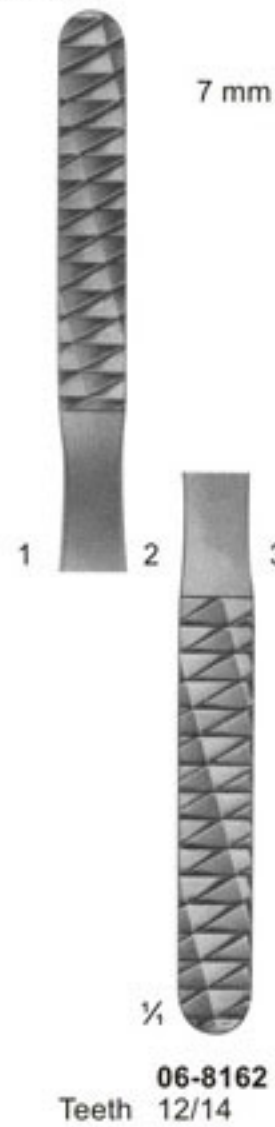
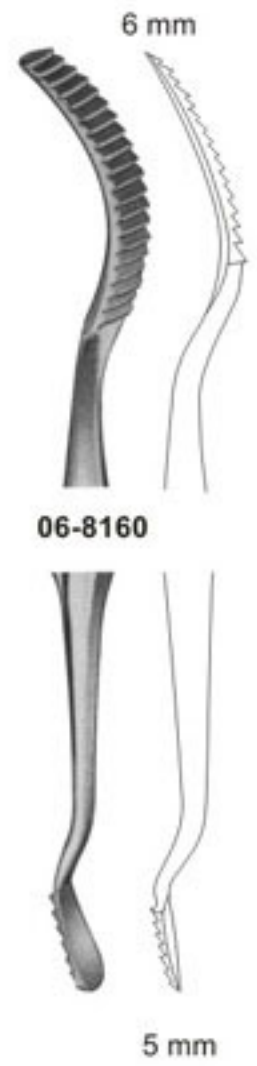
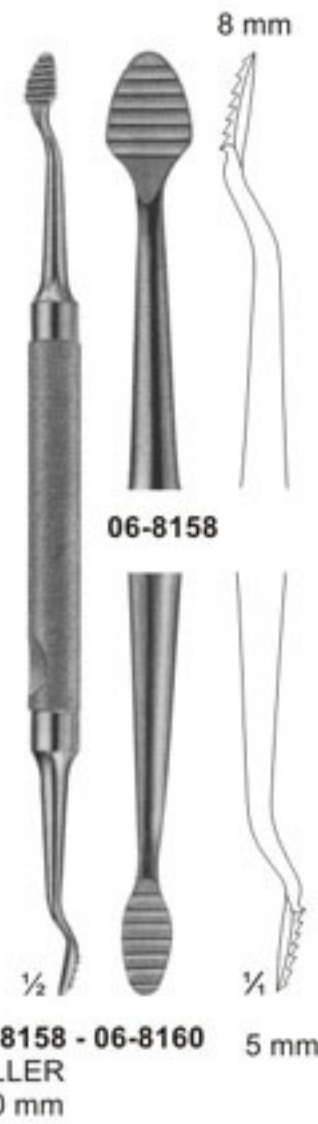
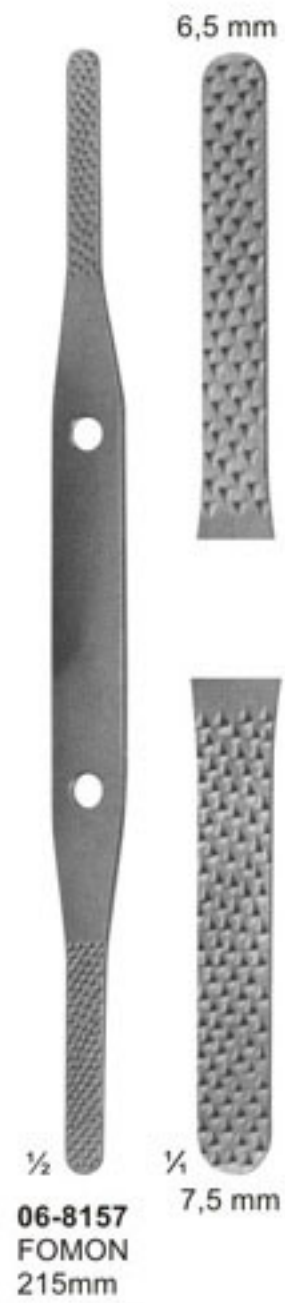



Bone File and Rasps

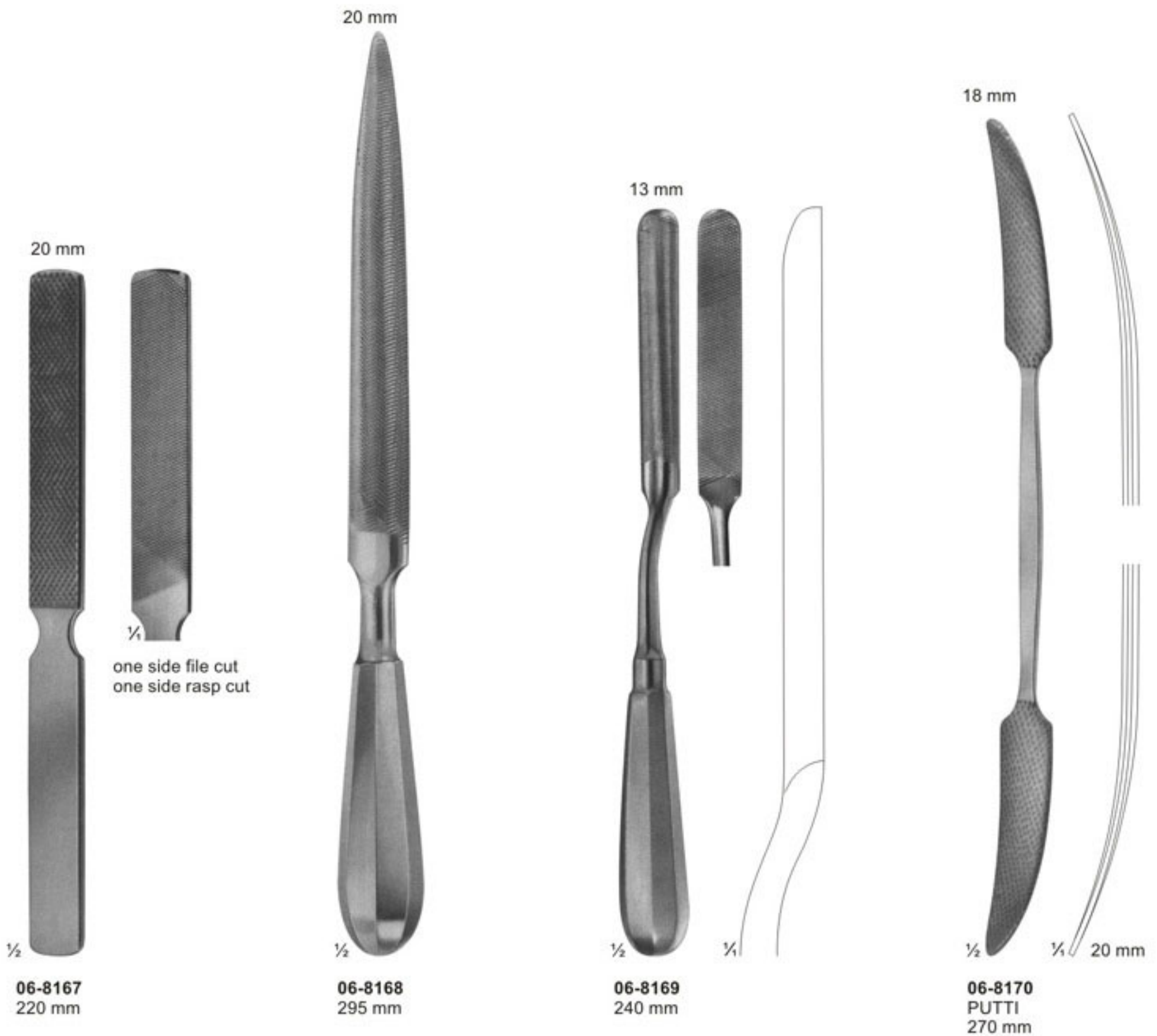



Bone Currettes



06-8171
JACOBSON
140 mm

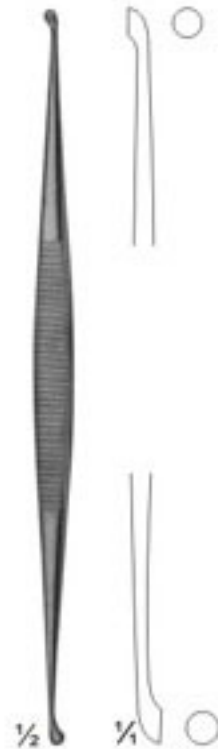

06-8172
MARTINI
140 mm



06-8173
MARTINI
140 mm



06-8174
WILLIGER
145 mm



06-8175
JANSEN
160 mm



06-8176
BARTH
180 mm



06-8177
VOLKMANN
130 mm

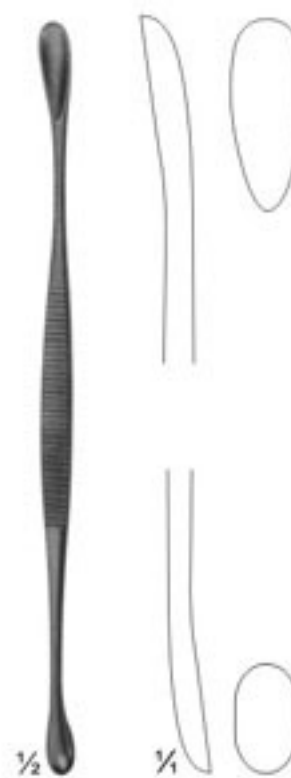

06-8178
VOLKMANN
145 mm



06-8179
VOLKMANN
170 mm



Bone Currettes



06-8180
JANSEN
160 mm



06-8181
HEMINGWAY
170 mm



06-8182
HEMINGWAY
175 mm



06-8183
LUCAS
180 mm



06-8184
LUCAS
185 mm



06-8185 - 06-8187
KERPEL
145 mm

06-8186 - 06-8188
KERPEL
145 mm

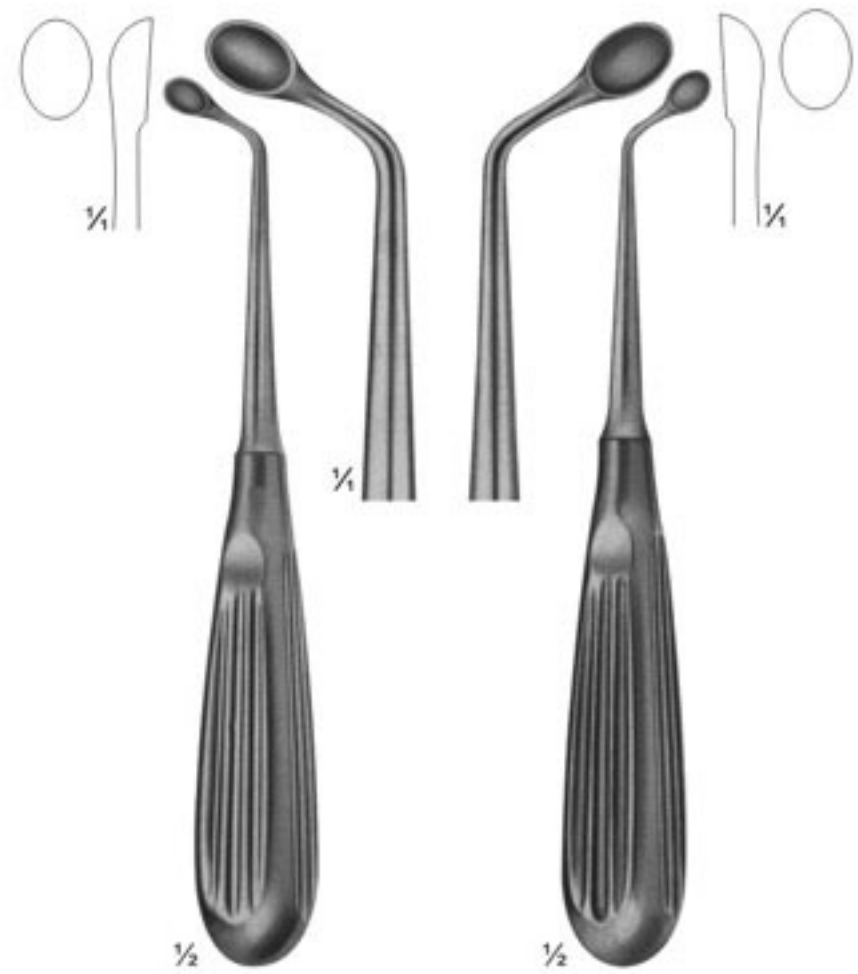

06-8189
UFFENORDE
170 mm

06-8190
UFFENORDE
170 mm



Bone Currettes



½

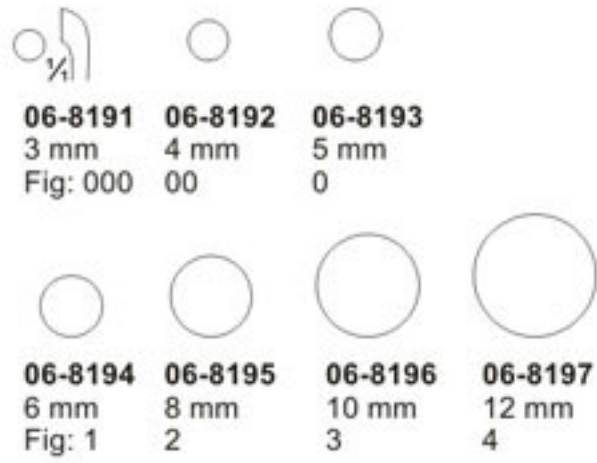

06-8191 - 06-8197
BRUNS
165 mm



½

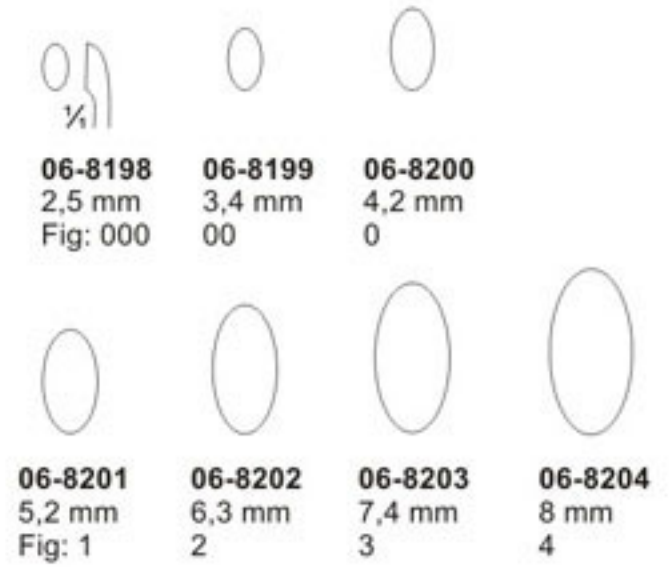

06-8198 - 06-8204
SCHEDE
170 mm



½

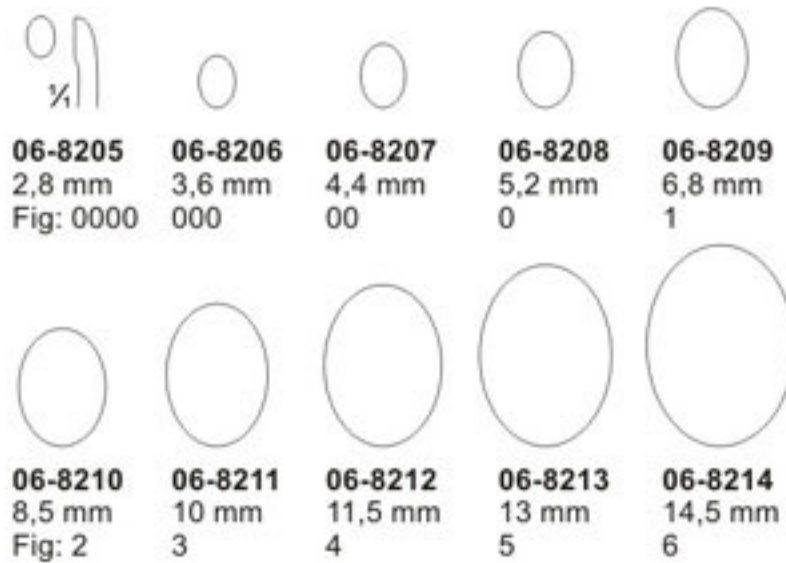

06-8205 - 06-8214
VOLKMANN
170 mm



½

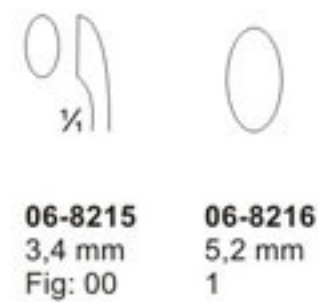

06-8215 - 06-8216
WILLIGER
170 mm



Bone Curettes



- 06-8217
1,8 mm
- 06-8218
2,0 mm
- 06-8219
2,4 mm
- 06-8220
2,6 mm
- 06-8221
2,8 mm

06-8217 - 06-8221
LEMPERT
215 mm



- malleable
- 06-8222
4,4 mm
Fig: 00
 - 06-8223
5,2 mm
Fig: 0
 - 06-8224
6,8 mm
Fig: 1

06-8222 - 06-8224
HALLE
215 mm



- 06-8225
2,8 mm
Fig: 0000
- 06-8226
3,6 mm
Fig: 000
- 06-8227
4,4 mm
Fig: 00
- 06-8228
5,2 mm
Fig: 0

06-8225 - 06-8228
DAUBENSPECK
200 mm



- 06-8229
3,6 mm
Fig: 000
- 06-8230
4,4 mm
Fig: 00
- 06-8231
5,2 mm
Fig: 0
- 06-8232
6,8 mm
Fig: 1

06-8229 - 06-8232
250 mm



- 06-8233
3,6 mm
Fig: 000
- 06-8234
4,4 mm
Fig: 00
- 06-8235
5,2 mm
Fig: 0
- 06-8236
6,8 mm
Fig: 1

06-8233 - 06-8236
250 mm



- 06-8237
3 mm
- 06-8238
4 mm
- 06-8239
5 mm

06-8237 - 06-8239
BUSHE 250 mm



Bone Curettes



06-8240
TESSIER
220 mm



06-8241
3,6 mm
Fig: 000

06-8242
4,4 mm
Fig: 00

06-8243
5,2 mm
Fig: 0

06-8241 - 06-8243
SIMON
235 mm

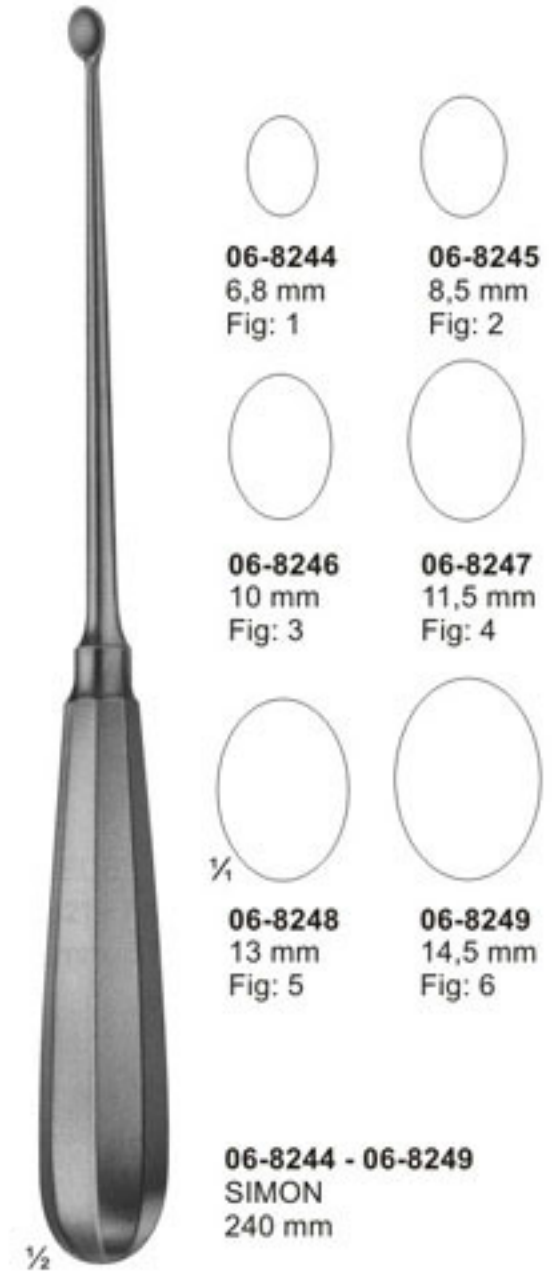

06-8244
6,8 mm
Fig: 1

06-8245
8,5 mm
Fig: 2

06-8246
10 mm
Fig: 3

06-8247
11,5 mm
Fig: 4

06-8248
13 mm
Fig: 5

06-8249
14,5 mm
Fig: 6

06-8244 - 06-8249
SIMON
240 mm



06-8250
3,6 mm
Fig: 000

06-8251
4,4 mm
Fig: 00

06-8252
5,2 mm
Fig: 0

06-8250 - 06-8252
CASPAR
220 mm



06-8253
3,6 mm
Fig: 000

06-8254
4,4 mm
Fig: 00

06-8255
5,2 mm
Fig: 0

06-8253 - 06-8255
CASPAR
220 mm



06-8256
4 mm

06-8257
5 mm

06-8258
6 mm

06-8256 - 06-8258
CASPAR
toothed
220 mm



Bone Currettes With Hartpress Handle

can be sterilized in a steam sterilizer upto 3 bar over pressure (143°C).



- 4,4 mm
Fig. 00
06-8259
- 6,8 mm
Fig. 1
06-8260
- 8,5 mm
Fig. 2
06-8261
- 10 mm
Fig. 3
06-8262

06-8259 - 06-8262
270 mm



- 2,8 mm
Fig. 0000
06-8263
- 3,6 mm
Fig. 000
06-8264
- 5,2 mm
Fig. 0
06-8265
- 10,0 mm
Fig. 3
06-8266
- 2,8 mm
Fig. 0000
06-8267
- 3,6 mm
Fig. 000
06-8268
- 5,2 mm
Fig. 0
06-8269
- 10,0 mm
Fig. 3
06-8270

06-8263 - 06-8270
SYPERT
380 mm