

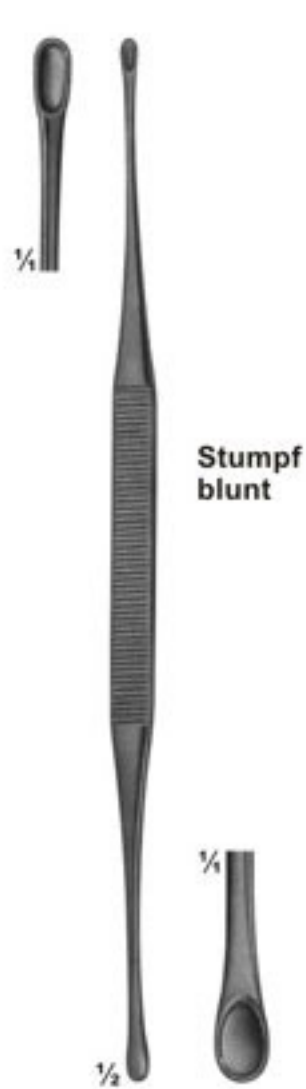

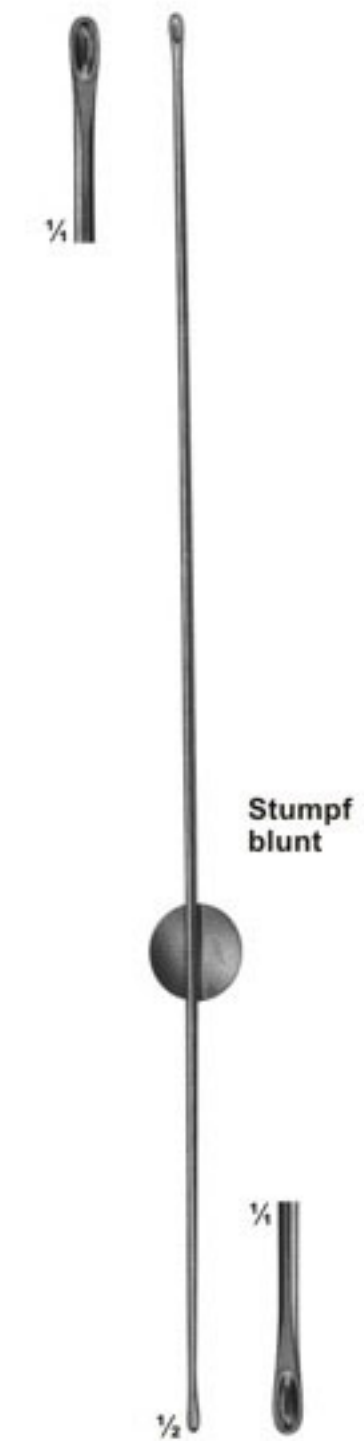

Biopsy Currettes

<p>Malleable</p>  <p>Stumpf blunt</p>	<p>Malleable</p>  <p>Stumpf blunt</p>	 <p>Luer-Lock</p>	 <p>Luer-Lock</p>
<p>04-6265 ASCH Uterine Secretion scoop 200 mm</p>	<p>04-6266 Uterine Secretion scoop 270 mm</p>	<p>04-6267 NOVAK-SCHOECKAERT Endometrial biopsy curette 240 mm</p>	<p>04-6268 RANDALL Endometrial biopsy curette 240 mm</p>



Biopsy Forceps

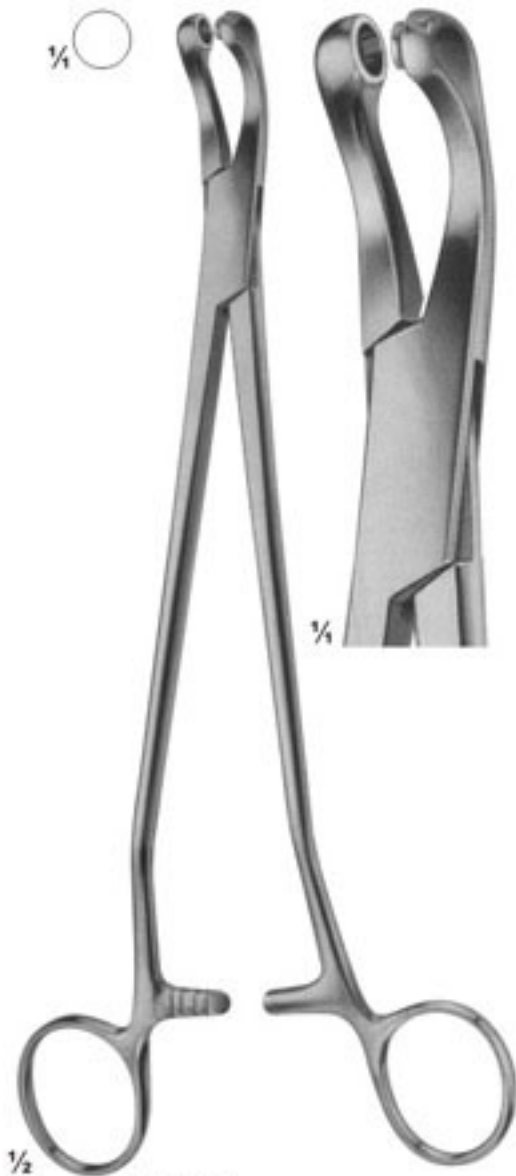

04-6269
THOMS-GAYLOR
240 mm



04-6270
SCHUBERT
260 mm



04-6271
FAURE
210 mm

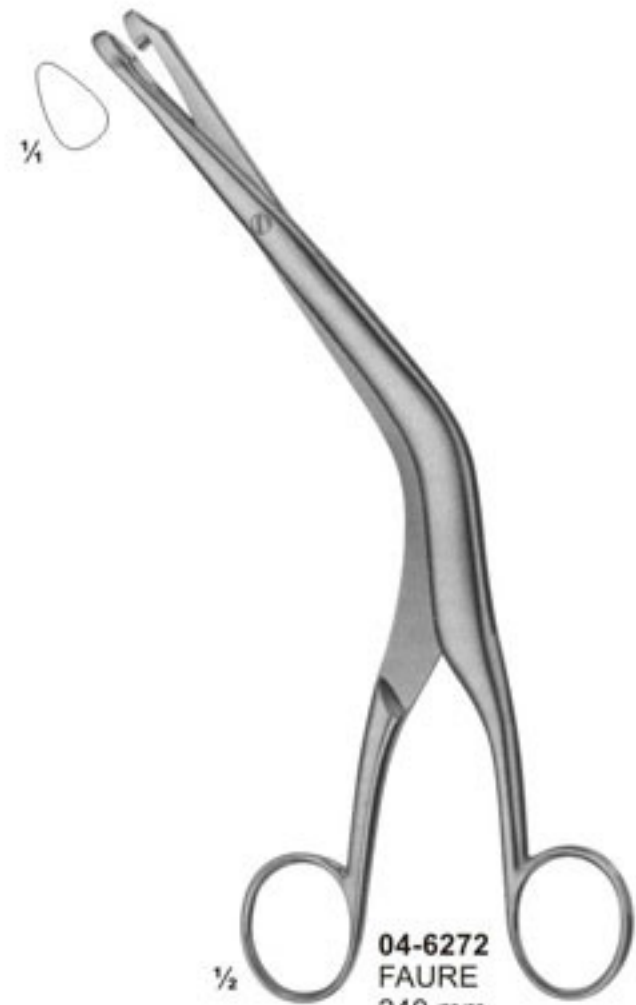

04-6272
FAURE
240 mm



Biopsy Forceps

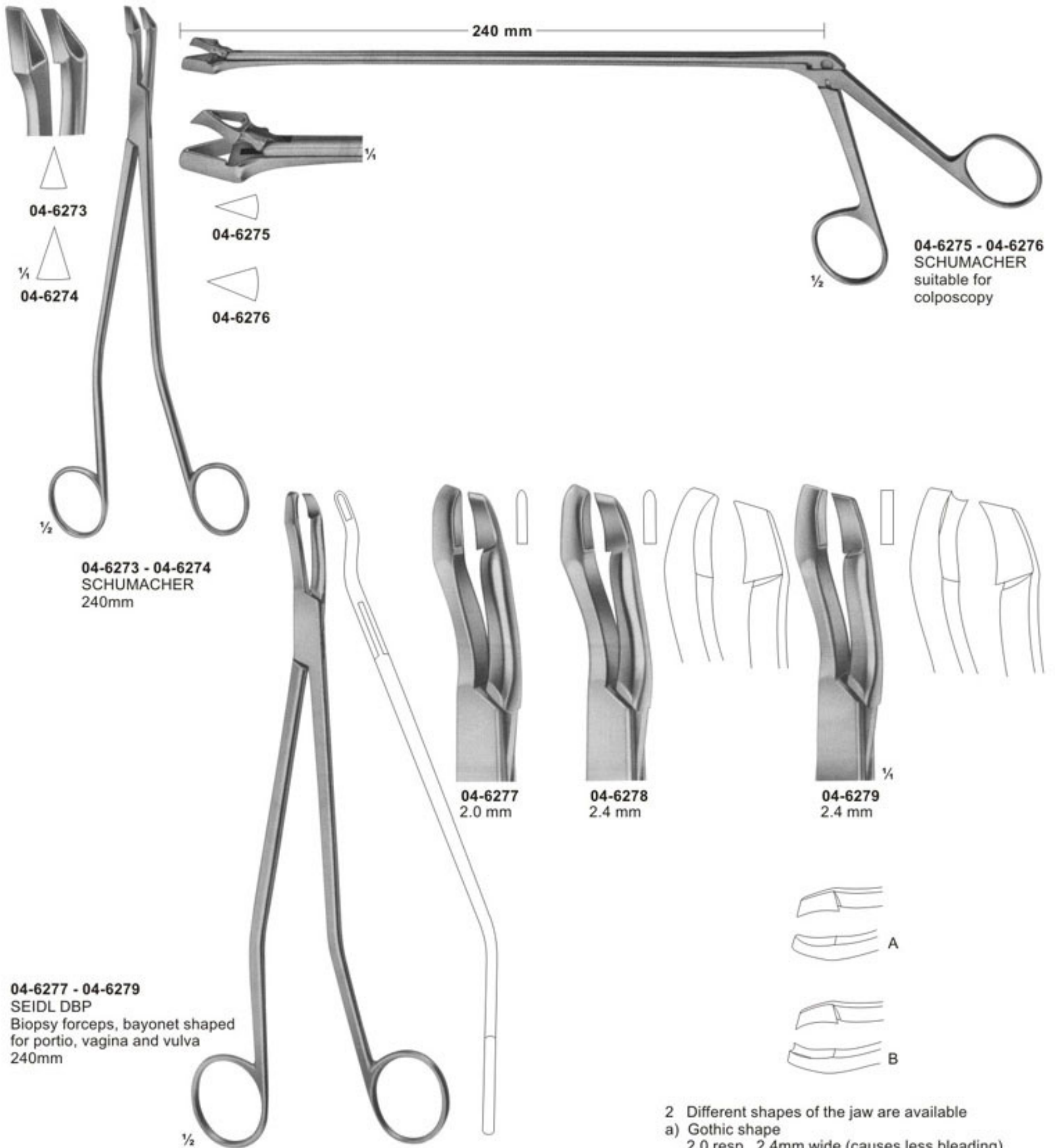

04-6273
04-6274

04-6275
04-6276

04-6275 - 04-6276
SCHUMACHER
suitable for
colposcopy

04-6273 - 04-6274
SCHUMACHER
240mm

04-6277
2.0 mm

04-6278
2.4 mm

04-6279
2.4 mm

04-6277 - 04-6279
SEIDL DBP
Biopsy forceps, bayonet shaped
for portio, vagina and vulva
240mm

2 Different shapes of the jaw are available
a) Gothic shape
2.0 resp 2.4mm wide (causes less bleeding)
b) Rectangular shape, 2.4mm wide



Biopsy Forceps

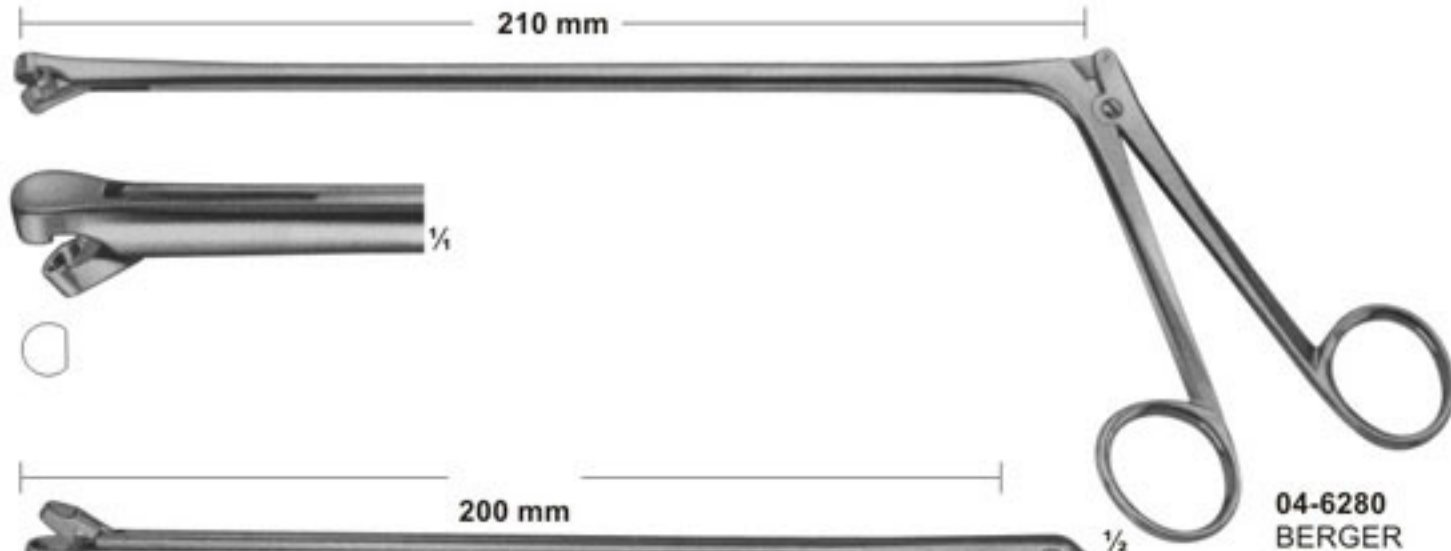

04-6280
BERGER

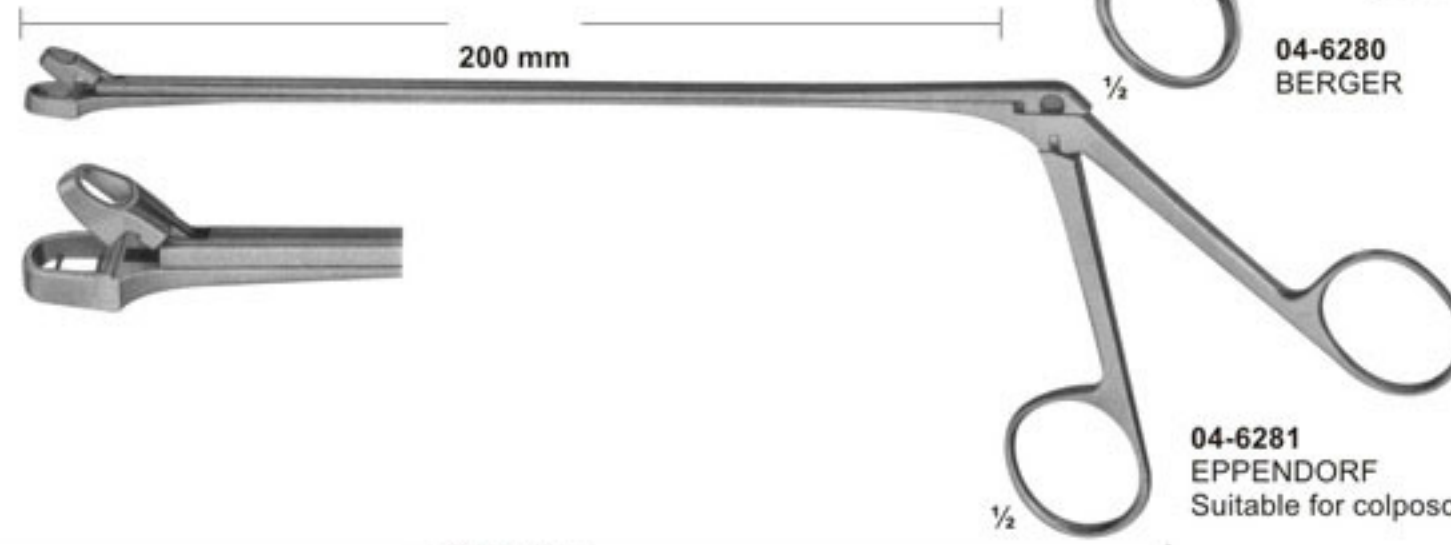

04-6281
EPPENDORF
Suitable for colposcopy

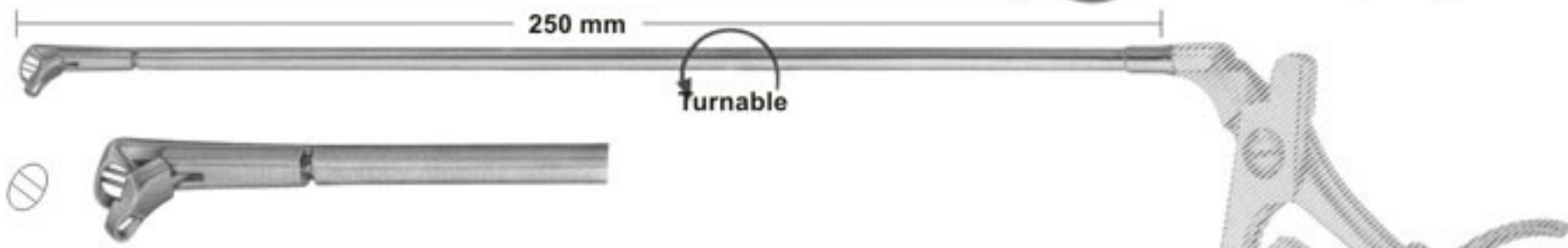

universal handle
with drawing cut,
beginning from the top

04-6283
attachment only

04-6282
for handle



04-6282



04-6289 KRAUSE (Biopsy tip)





Uterine Scoops

Table of Recamier		Sharp		Blunt
Fig	Width	Rigid	Malleable	Rigid
00	4.5mm	04-6294		
0	7.5mm	04-6295		04-6306
1	8.5mm	04-6296	04-6317	04-6307
2	10.5mm	04-6297	04-6318	04-6308
3	12.0mm	04-6298	04-6319	04-6309
4	14.0mm	04-6299	04-6320	04-6310
5	15.0mm	04-6300	04-6321	04-6311
6	16.5mm	04-6301	04-6322	04-6312
7	18.0mm	04-6302	04-6323	04-6313
8	19.5mm	04-6303	04-6324	04-6314
9	21.5mm	04-6304		04-6315
10	23.5mm	04-6305		04-6316
04-6294- 04-6305		Sharp - Rigid		
04-6317- 04-6324		Sharp - Malleable		
04-6306- 04-6316		Blunt - Rigid		

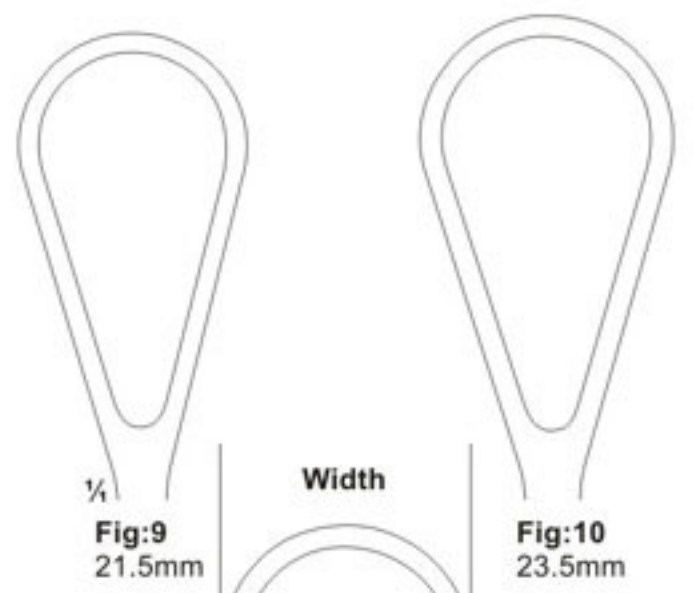
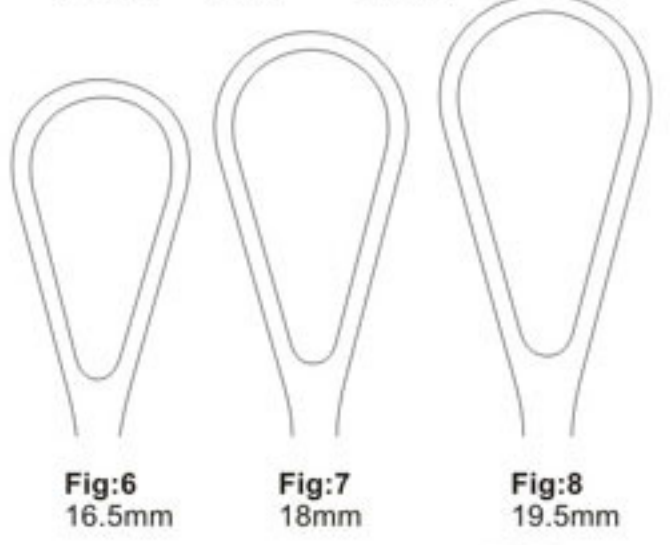
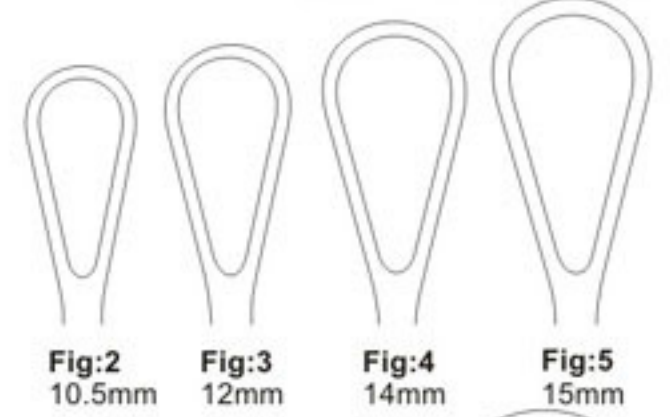
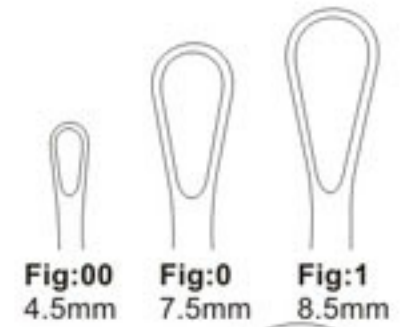

04-6292
SIMON
max.240 mm



04-6293
SCHRODER
max.310 mm

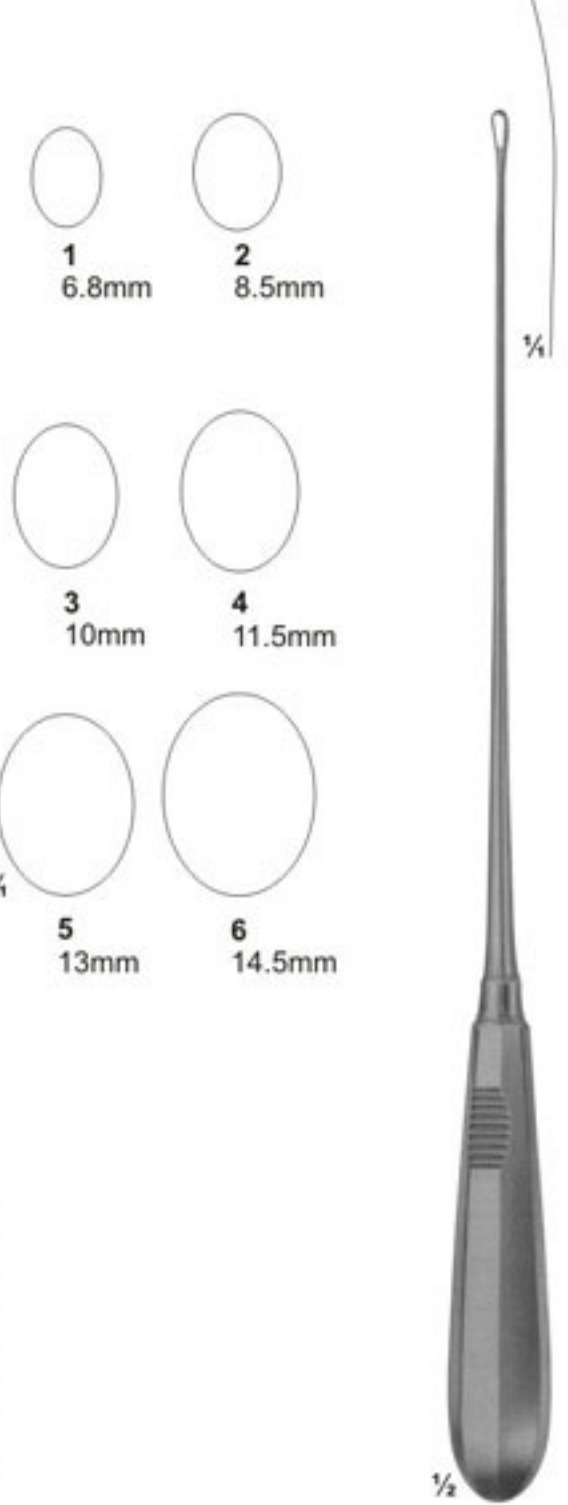

04-6294
RECAMIER
max.300 mm



Uterine Curettes

Fig	Width	Sharp		Blunt
		Rigid	Malleable	Rigid
1	7.5mm	04-6325	04-6331	04-6337
2	8.5mm	04-6326	04-6332	04-6338
3	10.5mm	04-6327	04-6333	04-6339
4	12.0mm	04-6328	04-6334	04-6340
5	14.0mm	04-6329	04-6335	04-6341
6	15.0mm	04-6330	04-6336	04-6342

04-6325 - 04-6330 Sharp - Rigid
 04-6331 - 04-6336 Sharp - Malleable
 04-6337 - 04-6342 Blunt - Rigid

Fig	Width	Blunt - Malleable
0	16.5mm	04-6343
1	18.5mm	04-6344
2	19.5mm	04-6345
3	21.5mm	04-6346
4	23.5mm	04-6347
5	26.0mm	04-6348
6	28.5mm	04-6349

BUMM

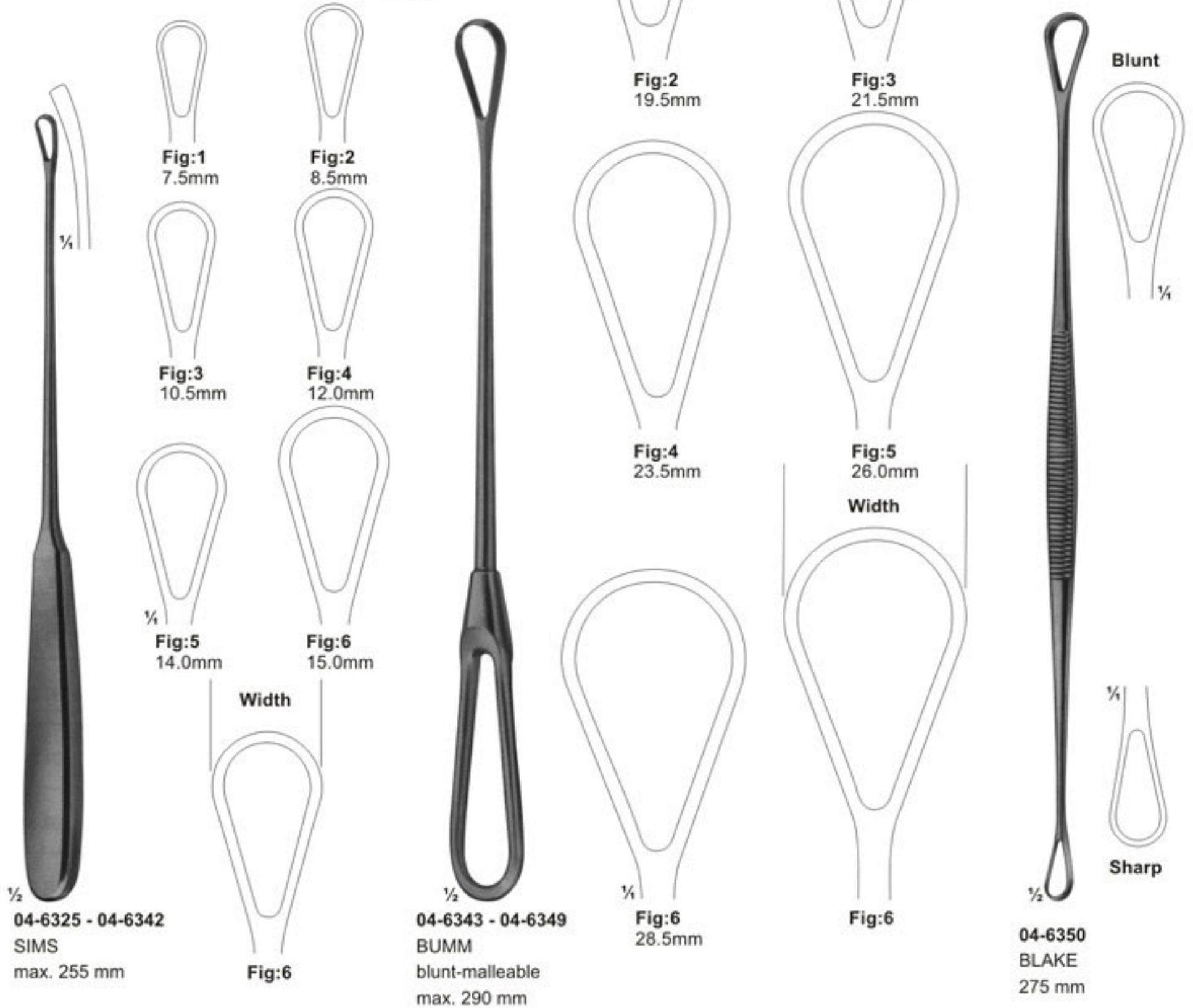

04-6325 - 04-6342
SIMS
max. 255 mm

04-6343 - 04-6349
BUMM
blunt-malleable
max. 290 mm

04-6350
BLAKE
275 mm



Placenta-and Ovum Curettes

Fig	Width	Sharp Malleable	Blunt Malleable
1	23.5mm	04-6354	04-6356
2	26.0mm		04-6357
3	28.5mm	04-6355	04-6358



04-6351
COLLIN
300 mm

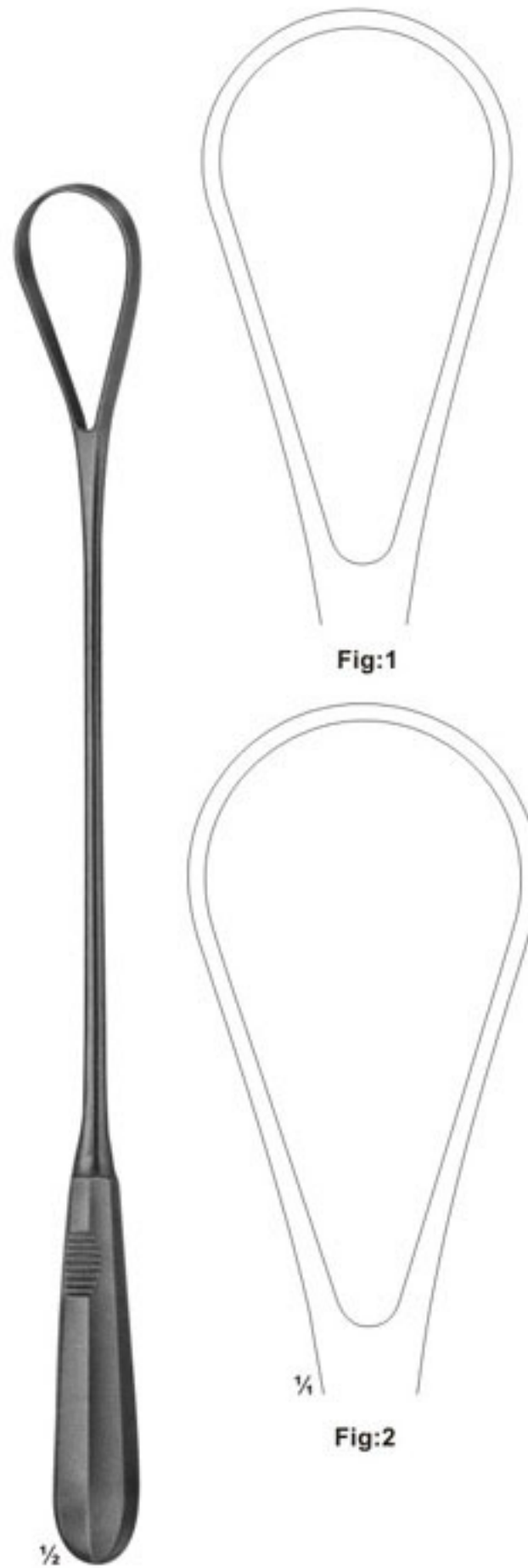

04-6352 - 04-6353
RECAMIER
blunt-rigid
max. 360 mm

Fig	Width	Blunt Rigid
1	34.5mm	04-6352
2	39.5mm	04-6353

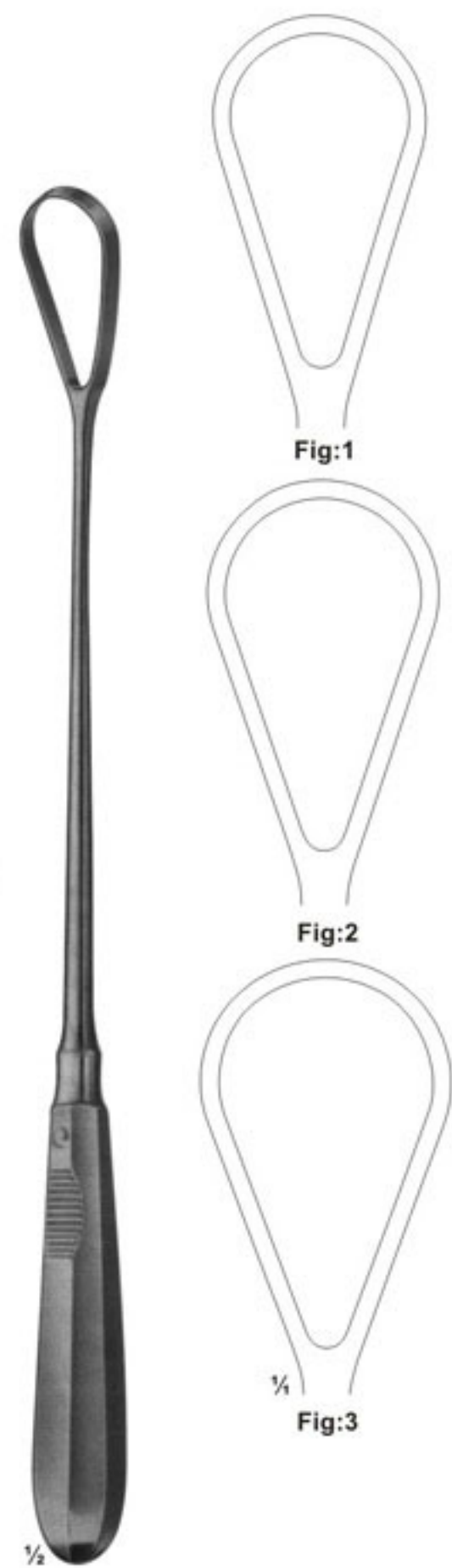

04-6354 - 04-6358
BUMM

max. 310 mm	
04-6354 - 04-6355	sharp-malleable
04-6356 - 04-6358	blunt-malleable



Vacuum Currettes

04-6359 - 04-6364

Suction currettes, stainless steel, fitting hose connection.

Working tips are smoothly rounded off, therefore no danger of perforation.



(suitable for suction biopsy)

04-6359: diam 4 mm

04-6360: diam 6 mm

04-6361: diam 8 mm

04-6362: diam 10 mm

04-6363: diam 12 mm

04-6364: diam 14 mm

04-6365

Hose connection inside diam. 11 mm, curved, stainless steel.



The new connection between suction curette and hose connection, (04-6365) Guarantees quick changing and free turning of the suction currettes on the hose connection.

04-6366

Transparent suction hose 1.8 mm long, inside diam 11 mm, outside diam 16.5 mm can be sterilized in an autoclave at 1 bar overpressure (120°C)

04-6367

Strainer for tissues, plastic, for single use only, to be used for histopathological examination.





Gynaecological Instruments



04-6368 diam 8 mm
04-6369 diam 10 mm
BOZEMANN-FRITSCH
 Uterine Flushing Tube
 350 mm

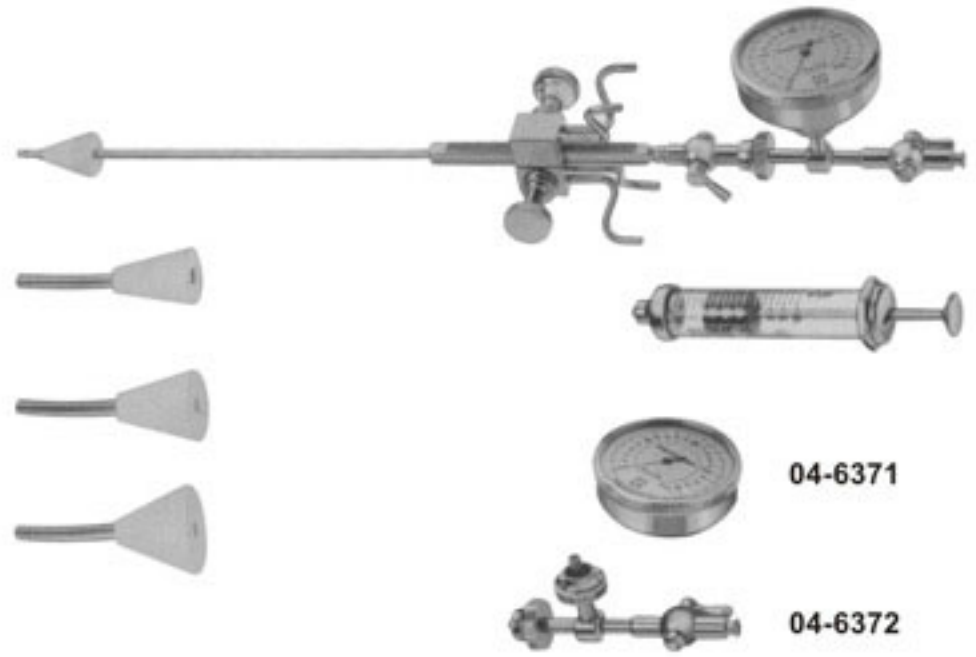

04-6370
SCHULZE
 Salpingograph, for utero-salpingography
 in wooden case, consisting of:
04-6371 Manometer only
04-6372 Connection only, without manometer
04-6373 Uterine cannula with tape without cone
04-6374 Cone only, small
04-6375 Cone only, medium
04-6376 Cone only, large
04-6377 Record syringe, 10CC, luer-lock mount.

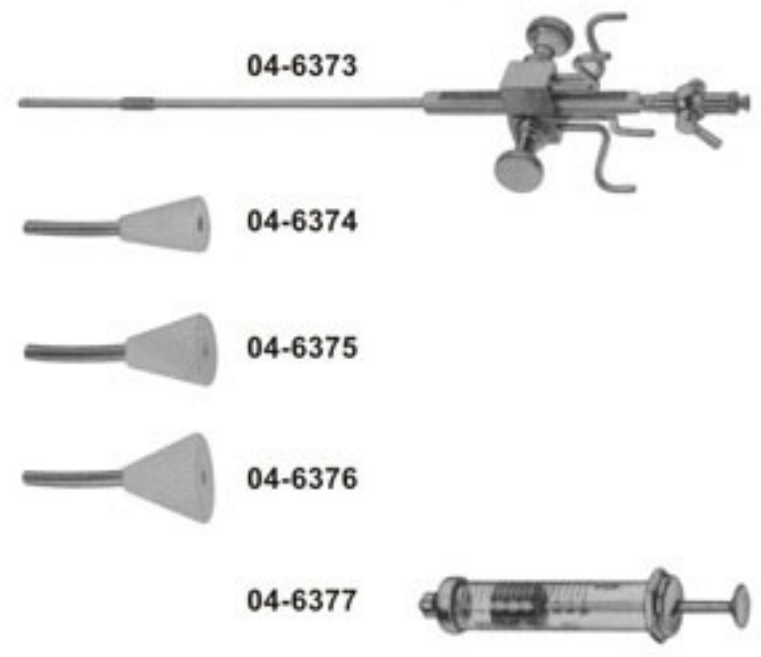

04-6378
SCHULZE
 Salpingograph, equipment like(04-6370)
 but without manometer.