

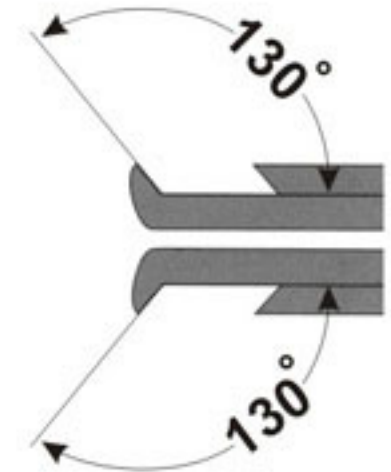

Punches

Angled positions for punches

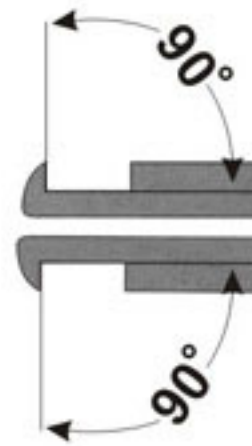
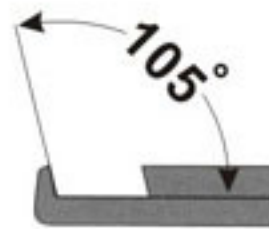

90° upwards cutting

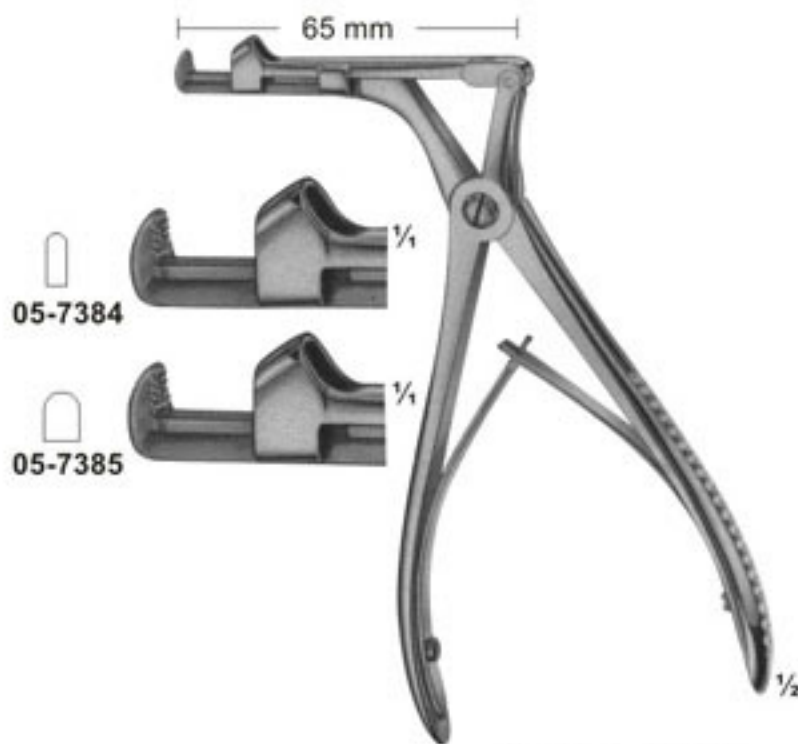

05-7384 - 05-7385
CITELLI
05-7384 2mm
05-7385 3.5mm

90° upwards cutting

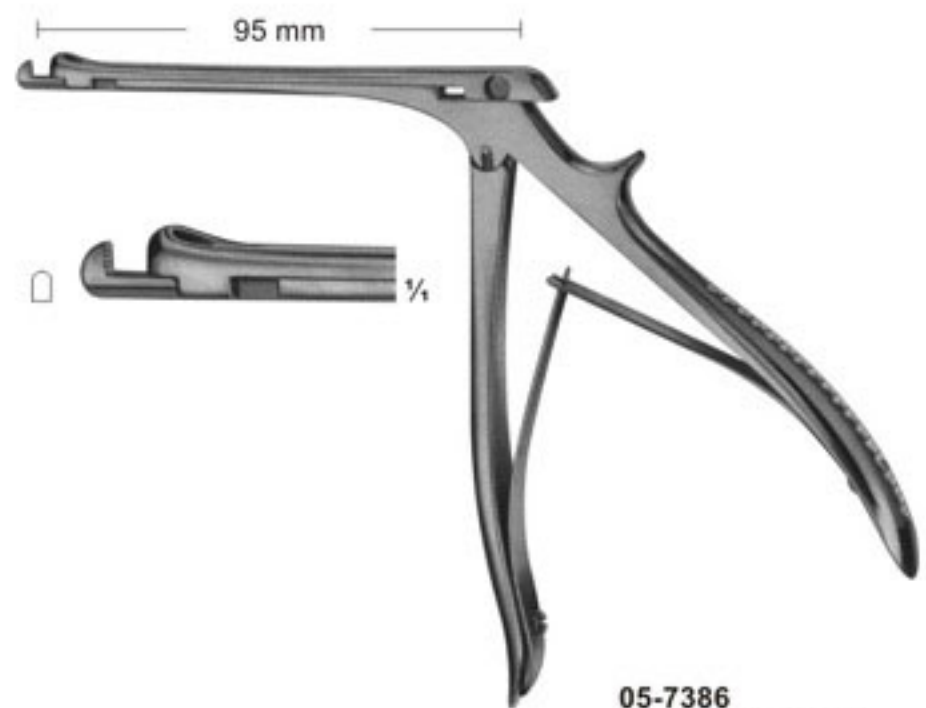

05-7386
CITELLI- BEYER
1,8 mm



Punches

90° upwards cutting

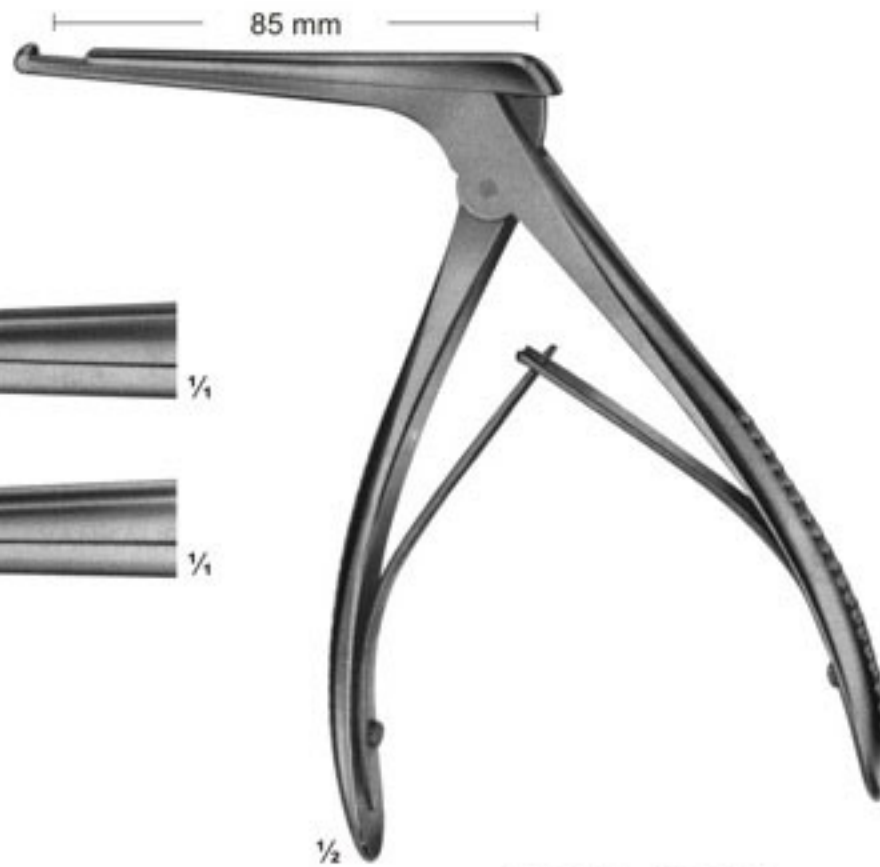

05-7387
4 mm



05-7388
5 mm



05-7387 - 05-7388
KERRISON

90° upwards cutting

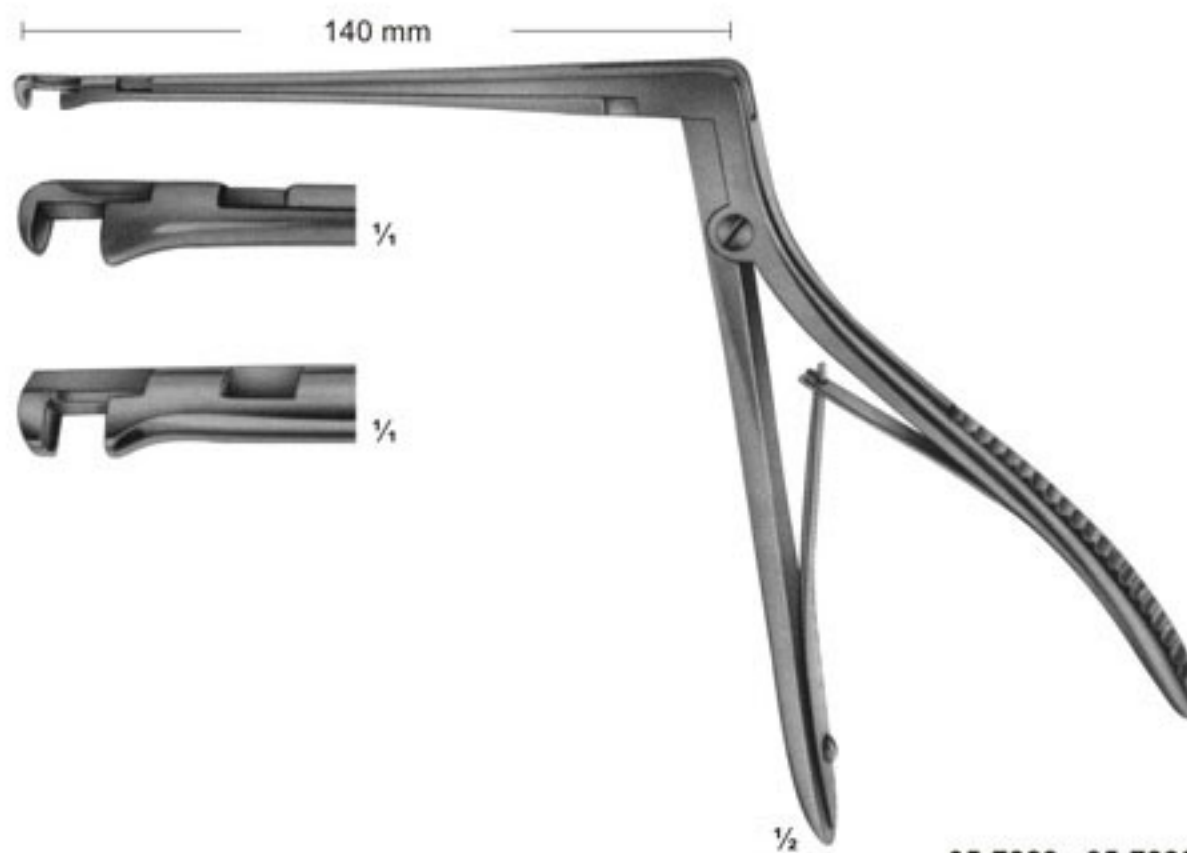

05-7389
3,3 mm



05-7390
4,0 mm



05-7389 - 05-7390
HAJEK-KOFLER



Punches

130° upwards cutting

KERRISON-JACOBY

05-7391
1 mm 

FERRIS-SMITH-KERRISON

05-7392
2 mm 

05-7393
3 mm 

05-7394
4 mm 

05-7395
5 mm 

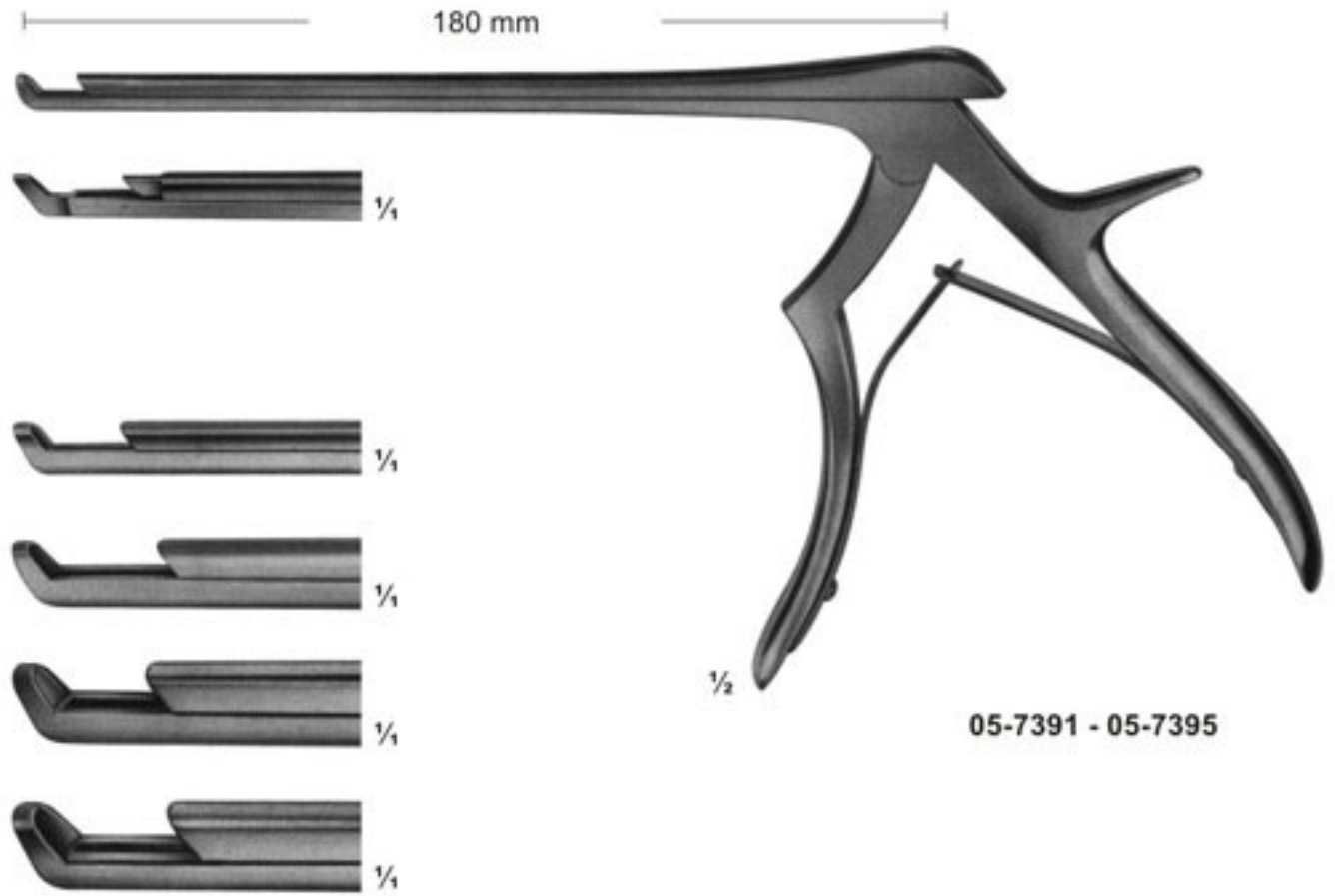

90° upwards cutting

KERRISON-JACOBY

05-7396
1 mm 

05-7397
2 mm 

FERRIS-SMITH-KERRISON

05-7398
3 mm 

05-7399
4 mm 

05-7400
5 mm 

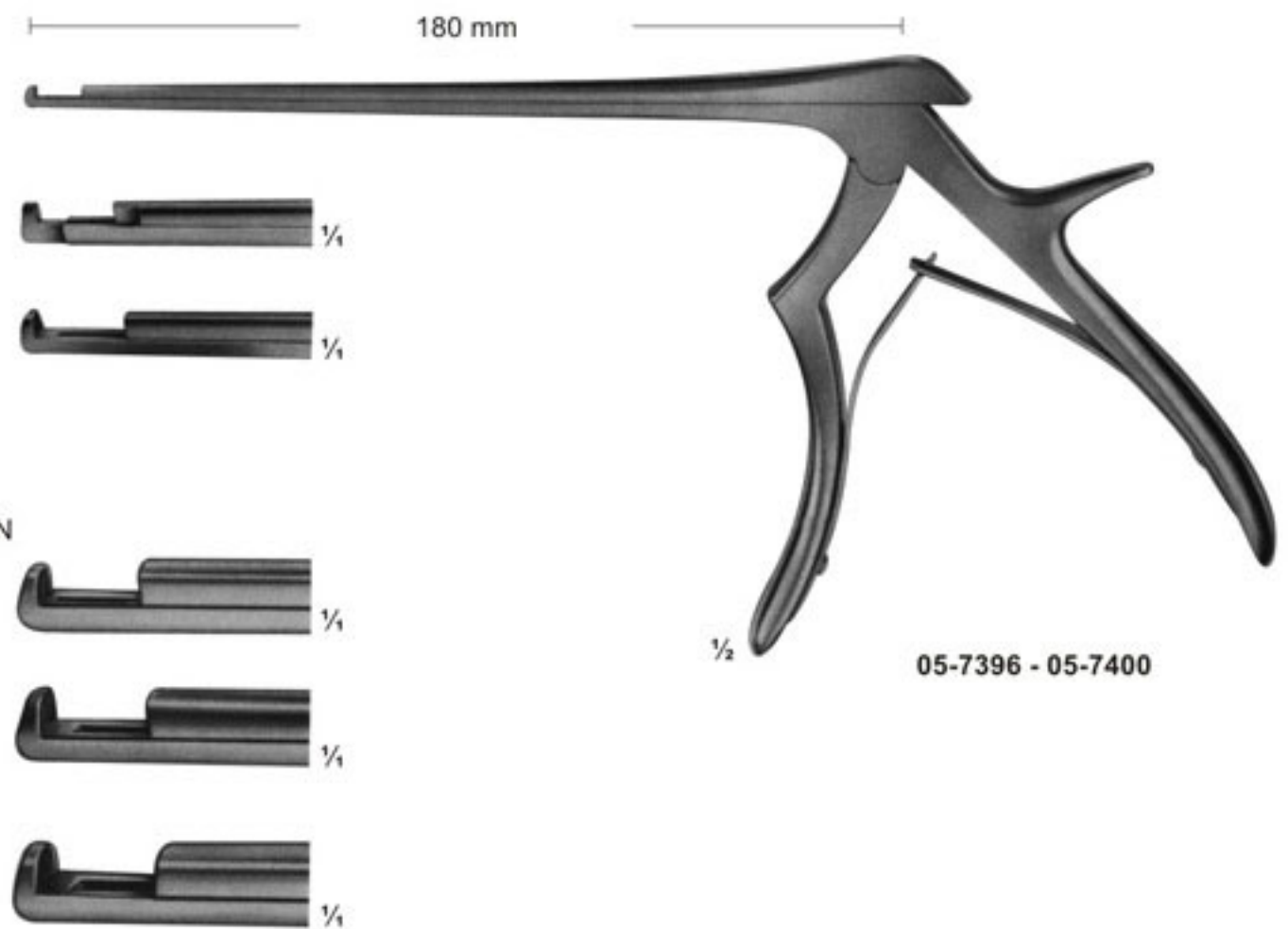



Rongeurs

Angled positions for rongeurs

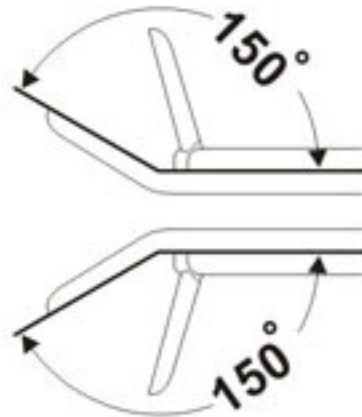

- 05-7401**
3,0 mm
- 05-7402**
3,6 mm
- 05-7403**
4,2 mm
- 05-7404**
4,8 mm
- 05-7405**
5,8 mm

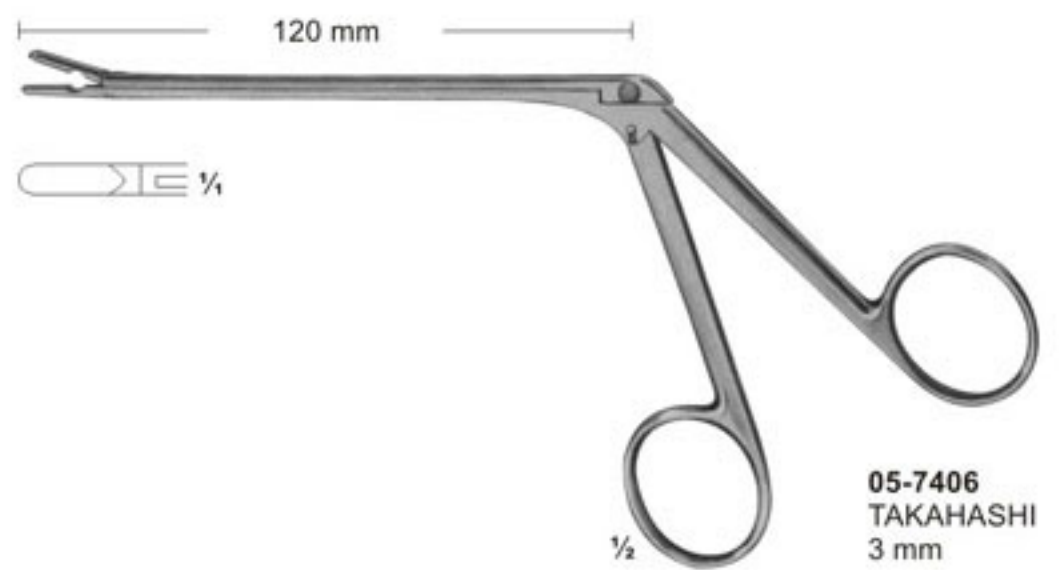
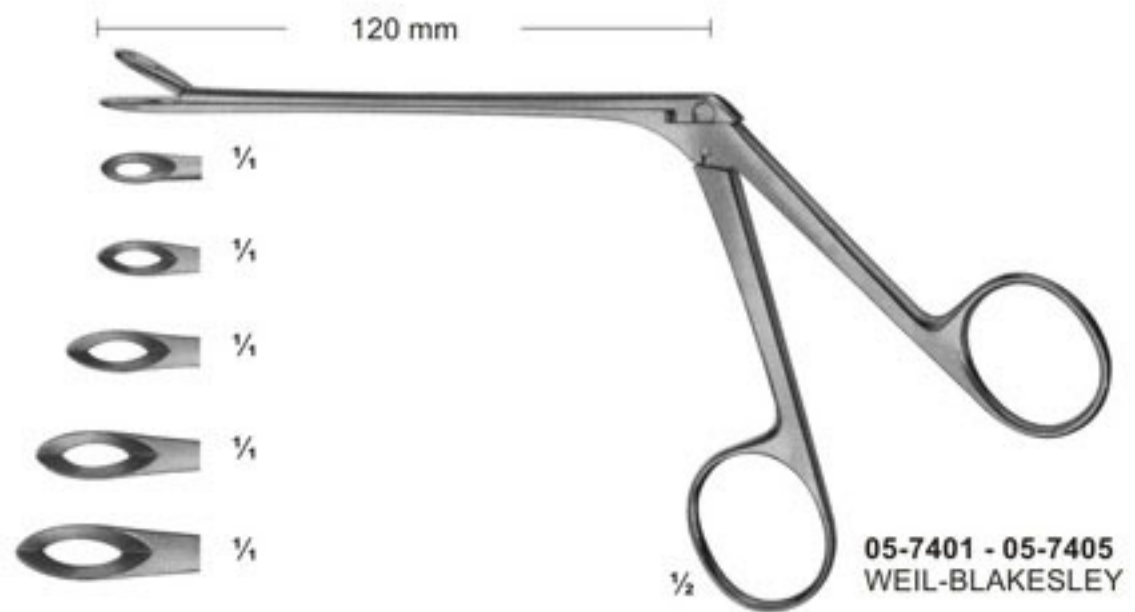
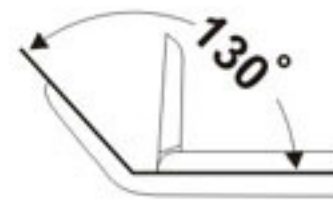
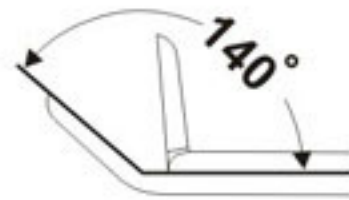

130°

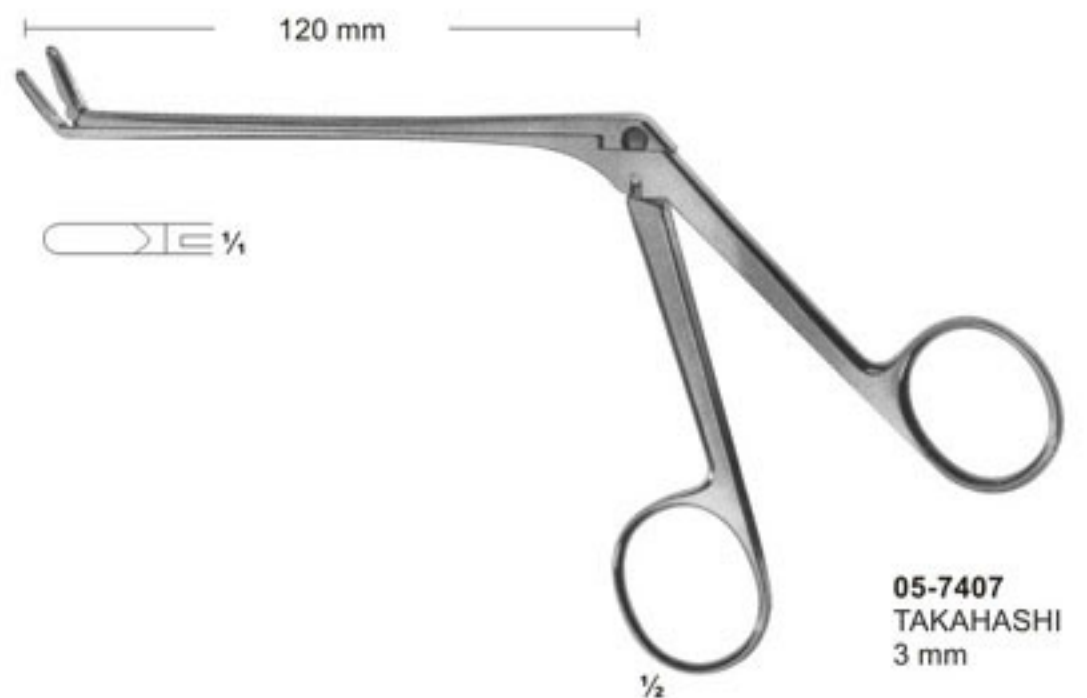



Rongeurs

LOVE-GRUENWALD

05-7408
2 X 10 mm

05-7409
3 X 10 mm

SPURLING

05-7410
4 X 10 mm

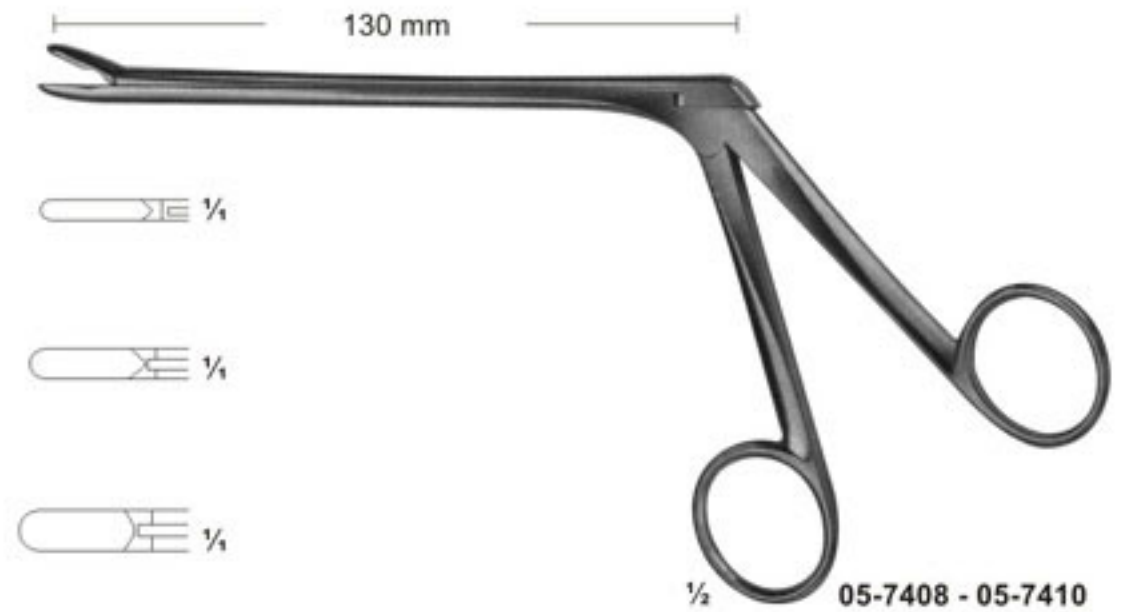

05-7408 - 05-7410

05-7411
2 mm

05-7412
3 mm

05-7413
4 mm

05-7414
5 mm

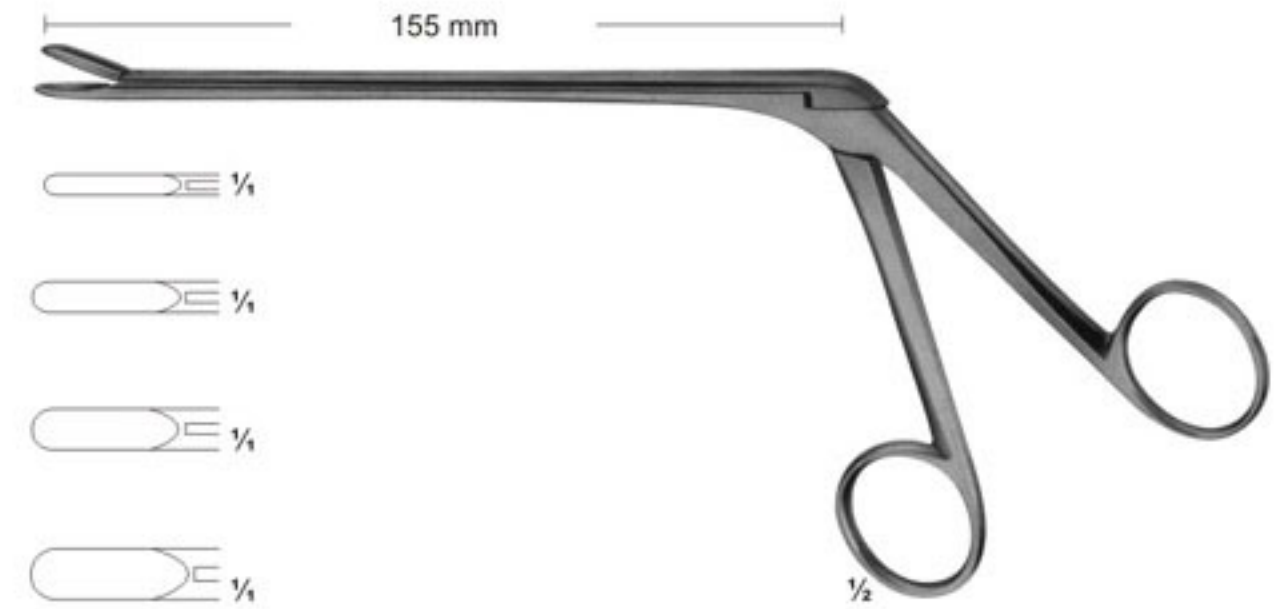

05-7411 - 05-7414
CASPAR

150°

05-7415
2 mm

05-7416
3 mm

05-7417
4 mm

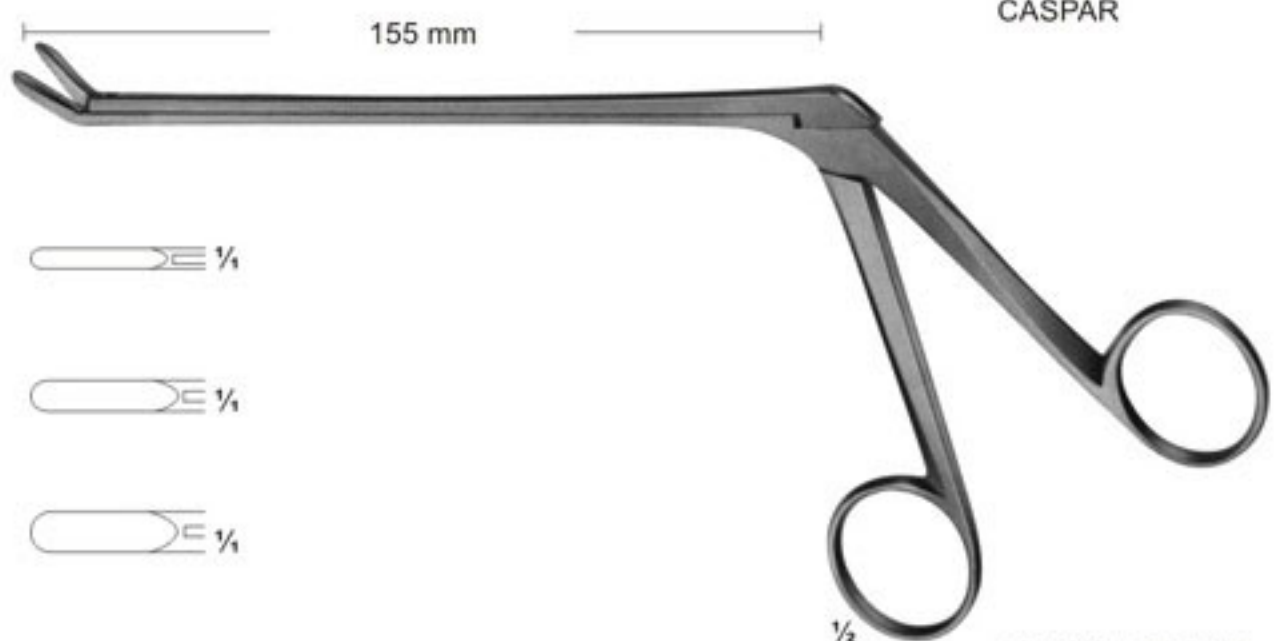

05-7415 - 05-7417
CASPAR



Rongeurs

150°

Lower part of jaws movable

05-7418
2 mm

05-7419
3 mm

05-7420
4 mm

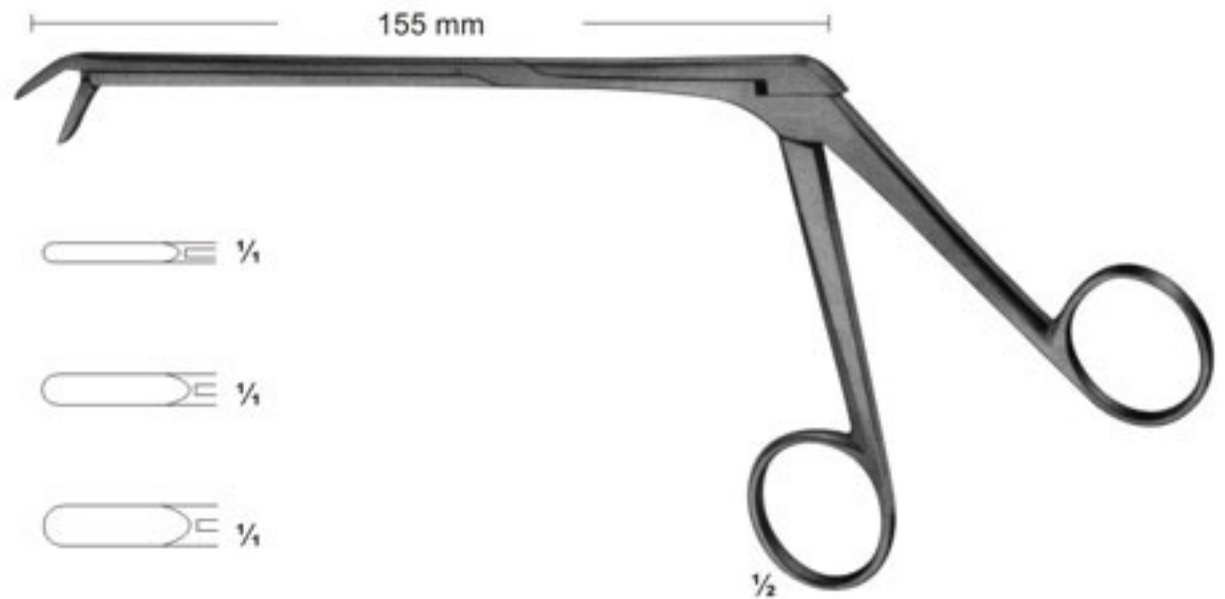

05-7418 - 05-7420
CASPAR

Length of shaft 140 mm	Length of shaft 160 mm	Length of shaft 185 mm	size of jaws
05-7421	05-7426	05-7431	2 X12 mm
05-7422	05-7427	05-7432	3 X12 mm
05-7423	05-7428	05-7433	4 X14 mm
05-7424	05-7429	05-7434	5 X14 mm
05-7425	05-7430	05-7435	6 X16 mm



05-7421 - 05-7435
CASPAR

150°

Length of shaft 140 mm	Length of shaft 160 mm	Length of shaft 185 mm	size of jaws
05-7436	05-7439	05-7442	3 X12 mm
05-7437	05-7440	05-7443	4 X14 mm
05-7438	05-7441	05-7444	5 X14 mm



05-7436 - 05-7444
CASPAR



Rongeurs

150°

Lower part of jaw movable

Length of shaft 140 mm	Length of shaft 160 mm	Length of shaft 185 mm	size of jaws
05-7445	05-7447	05-7449	3 X 12 mm
05-7446	05-7448	05-7450	4 X 14 mm

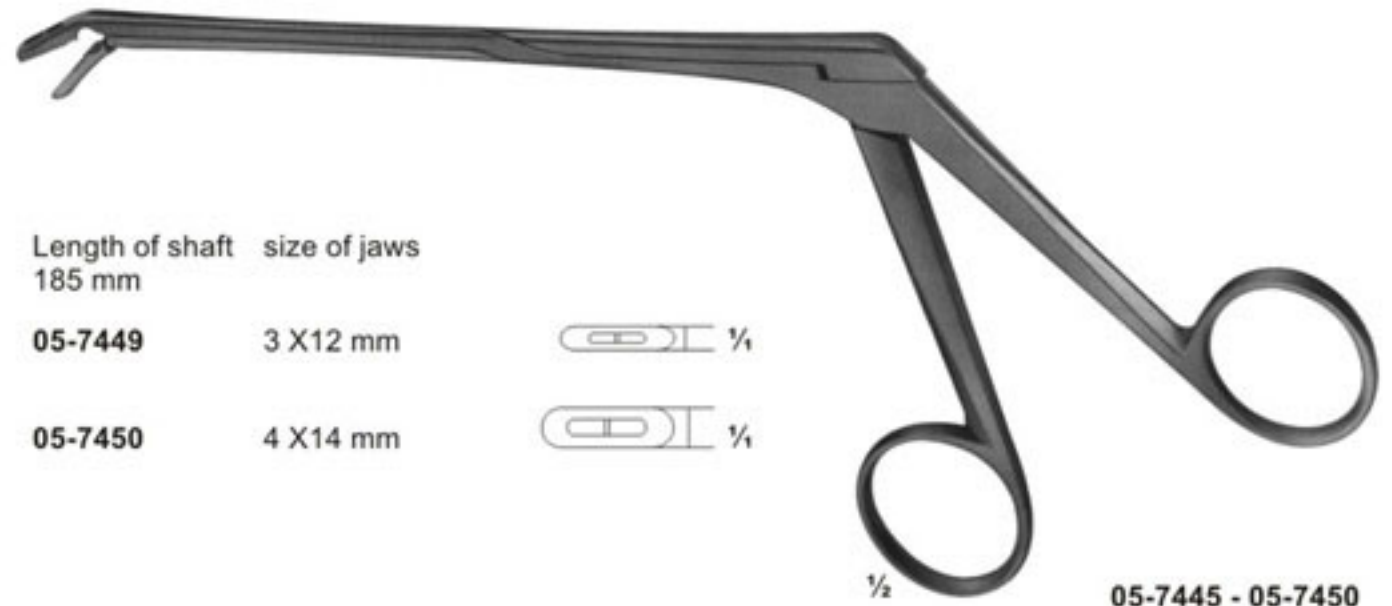
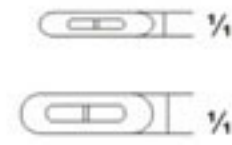

05-7445 - 05-7450
CASPAR

05-7451
2 X 10 mm
CUSHING

05-7452
3 X 10 mm
LOVE-GRUENWALD

05-7453
4 X 10 mm
SPURLING

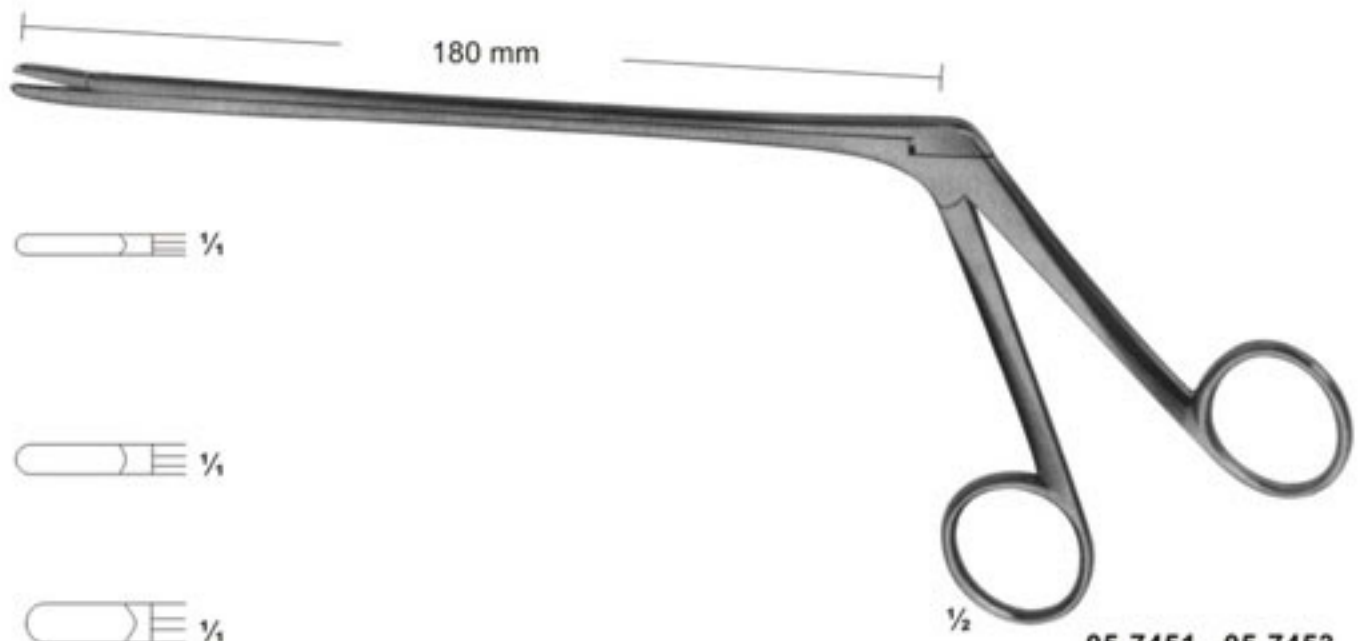
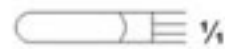
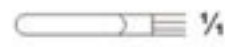

05-7451 - 05-7453

150°

05-7454
3 X 10 mm
LOVE-GRUENWALD

05-7455
4 X 10 mm
SPURLING

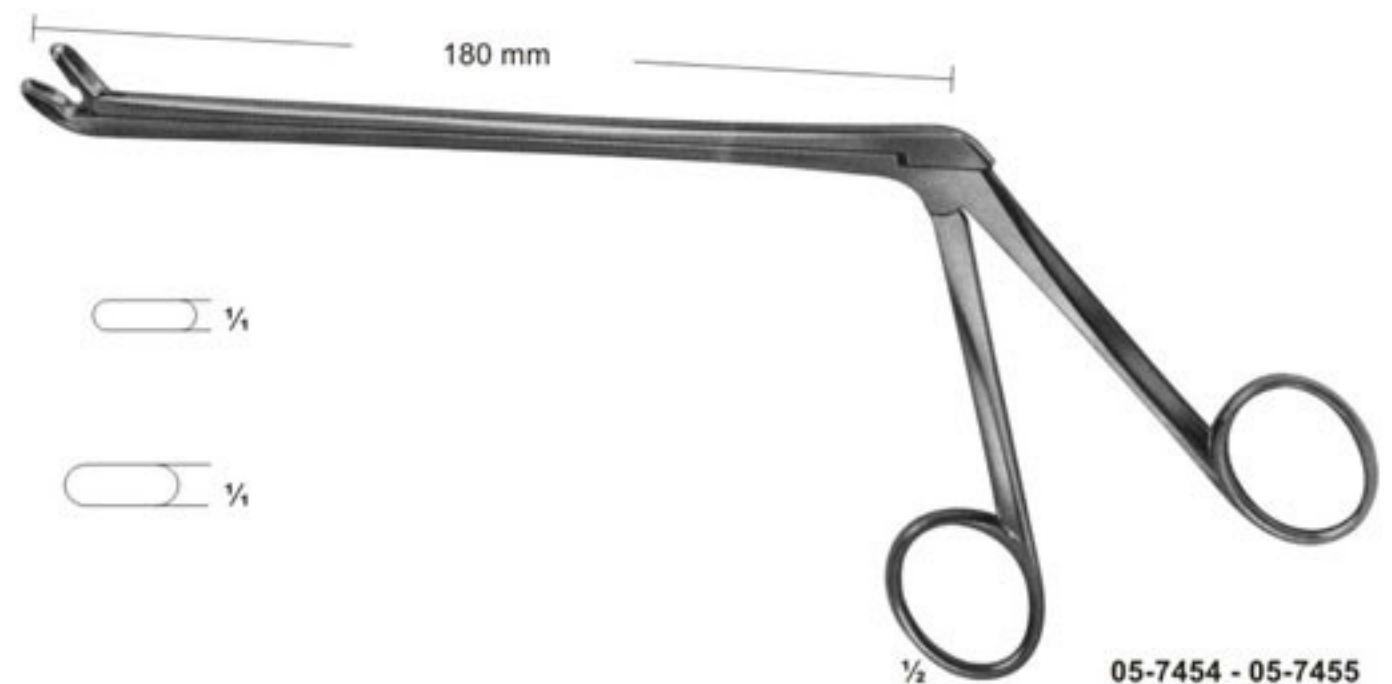

05-7454 - 05-7455



Rongeurs

150°

Upper part of jaw
movable

05-7456
3 X 10 mm
LOVE-GRUENWALD

05-7457
4 X 10 mm
SPURLING

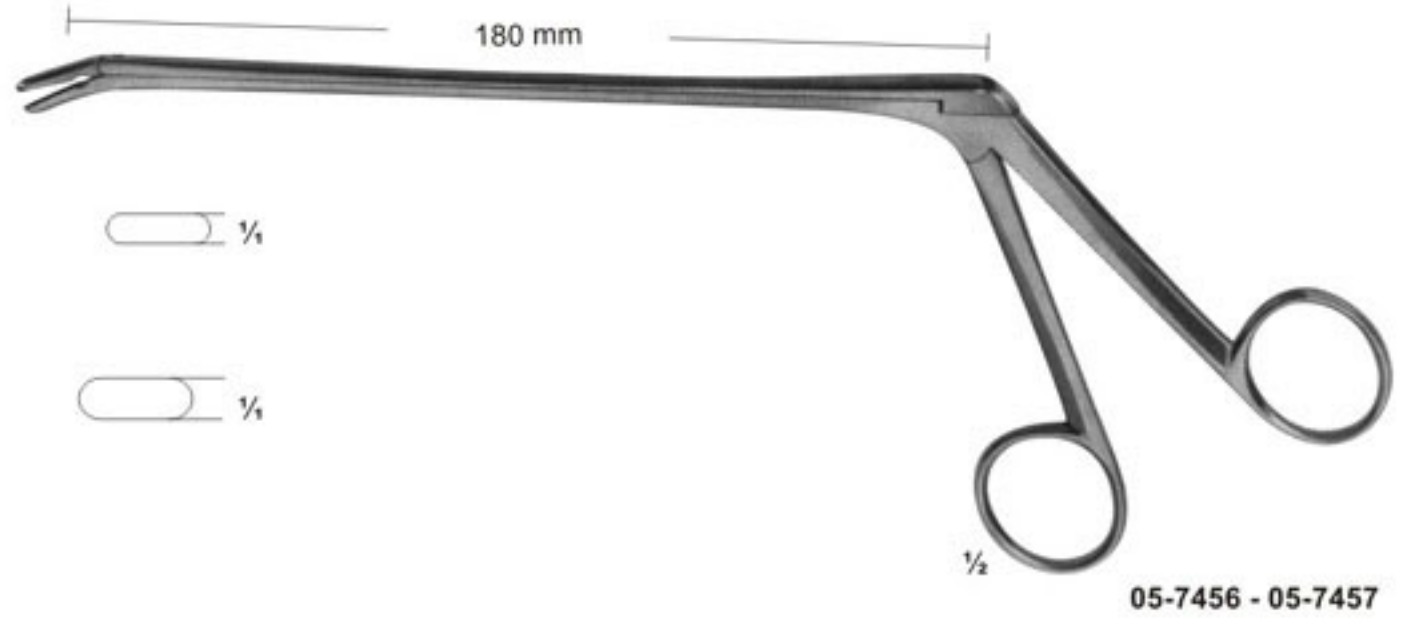

05-7458
Ø 7 mm

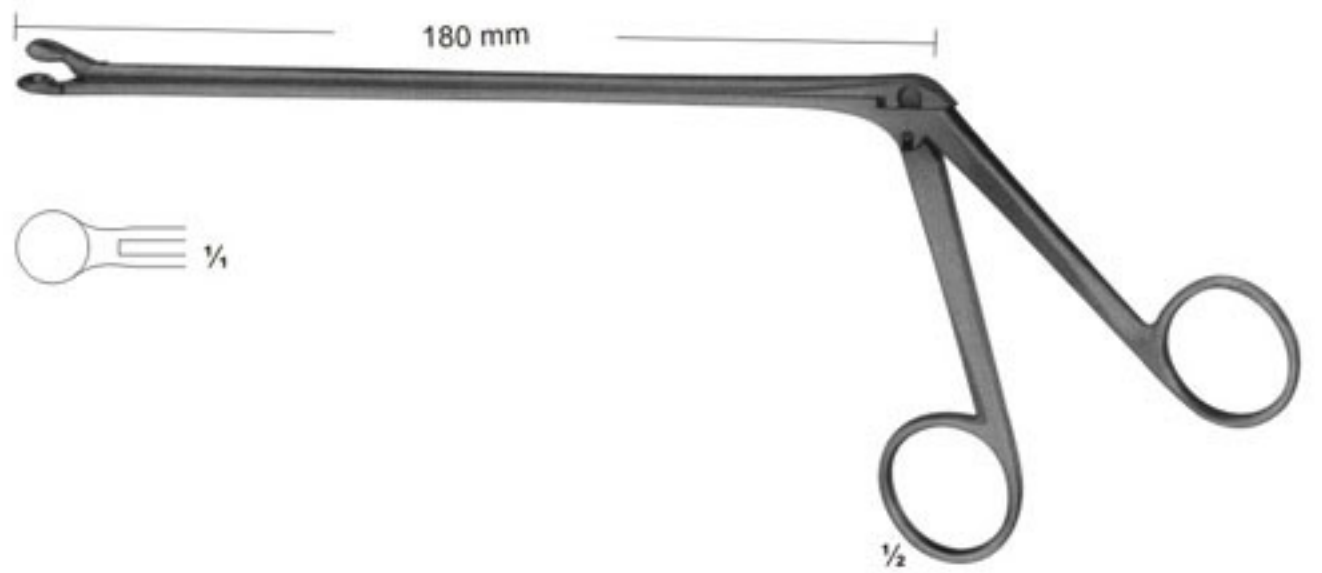

05-7459
YASARGIL
Ø 2,2 mm

05-7460
YASARGIL
Ø 3,5 mm

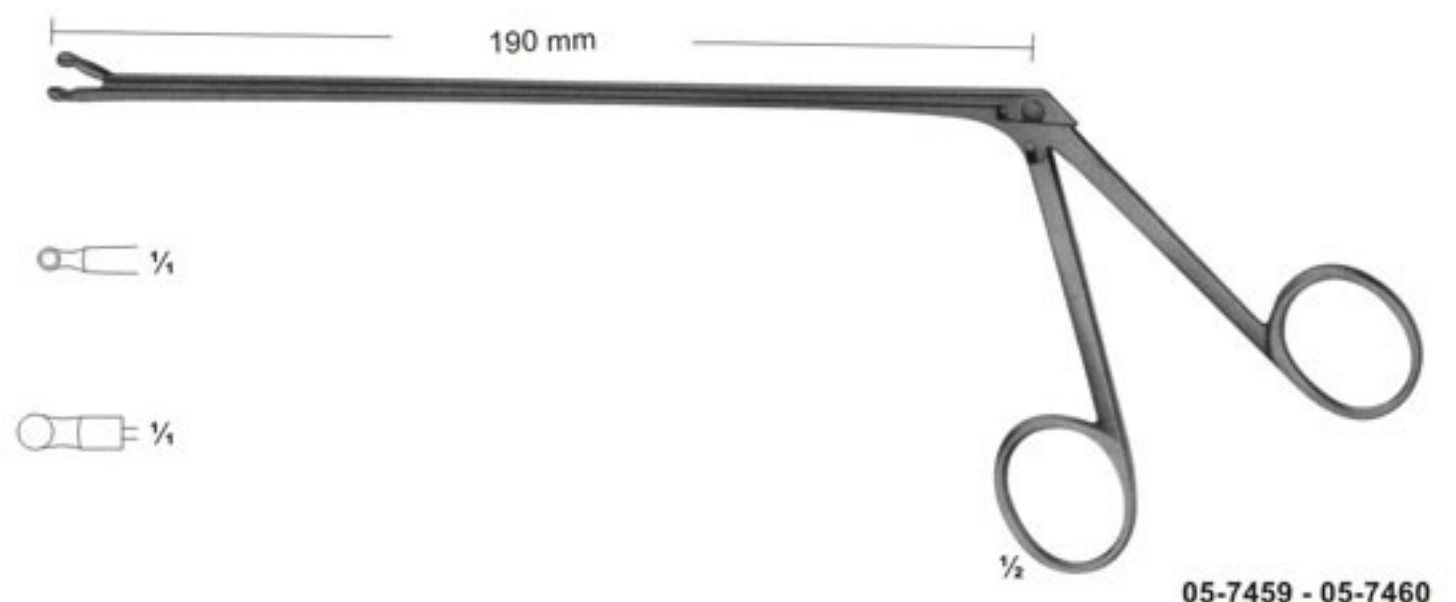



Rongeurs

05-7461
4 mm



Osteophyte Rongeur

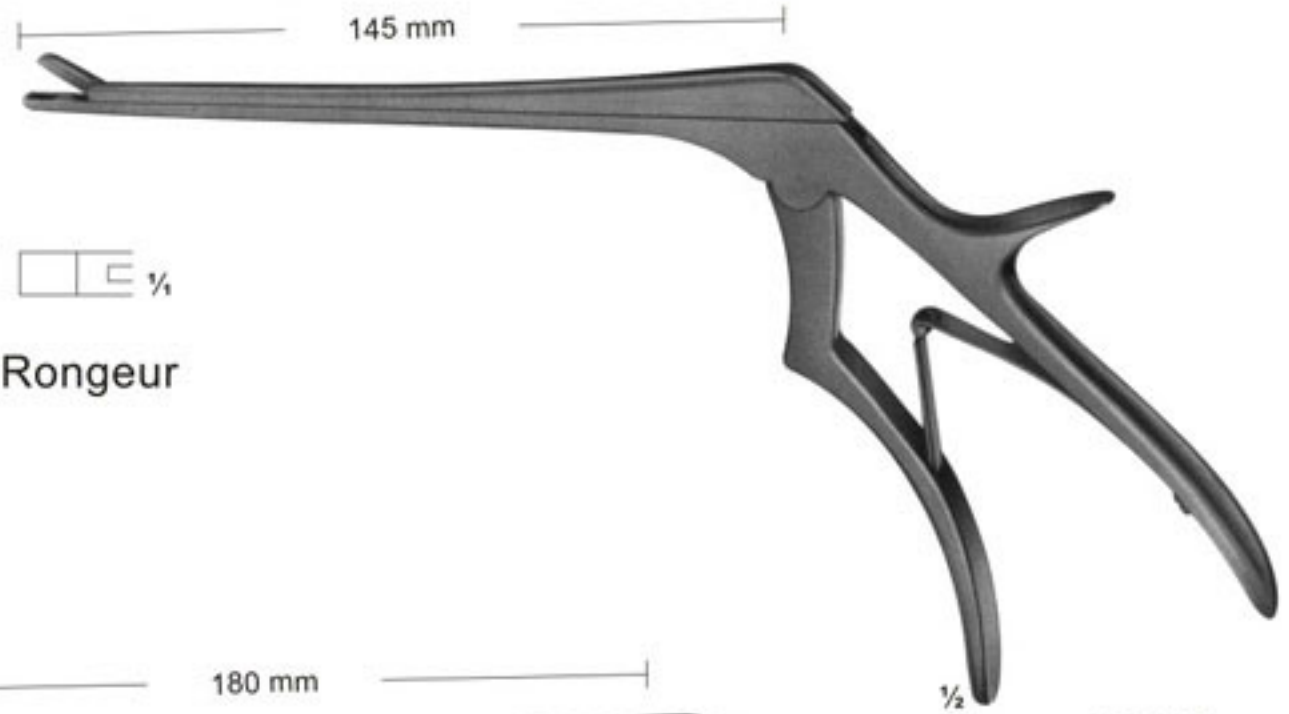

05-7461
CASPAR

05-7462
4 mm



Osteophyte Rongeur

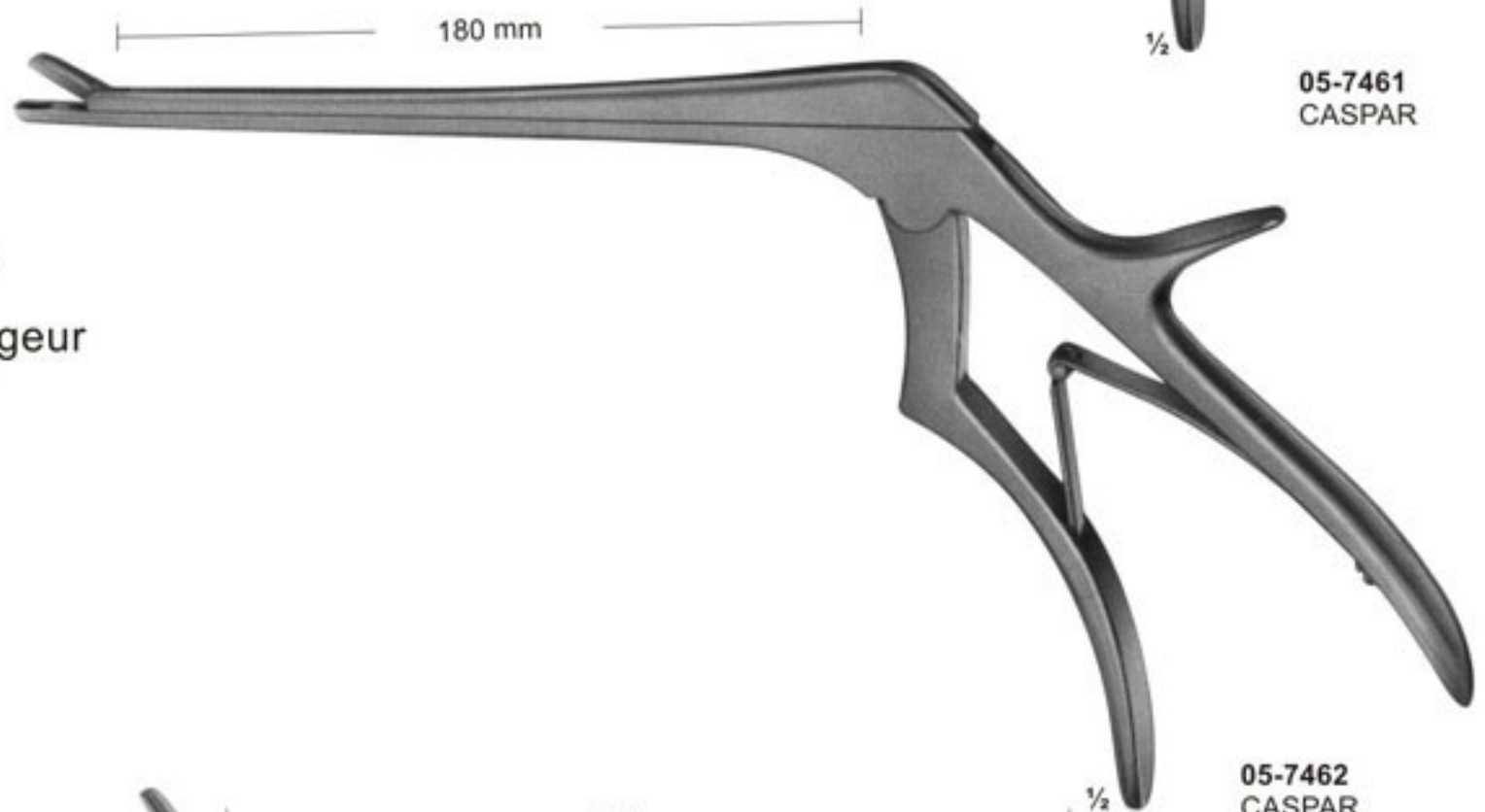

05-7462
CASPAR

05-7463
5,5 mm



Very Heavy Pattern

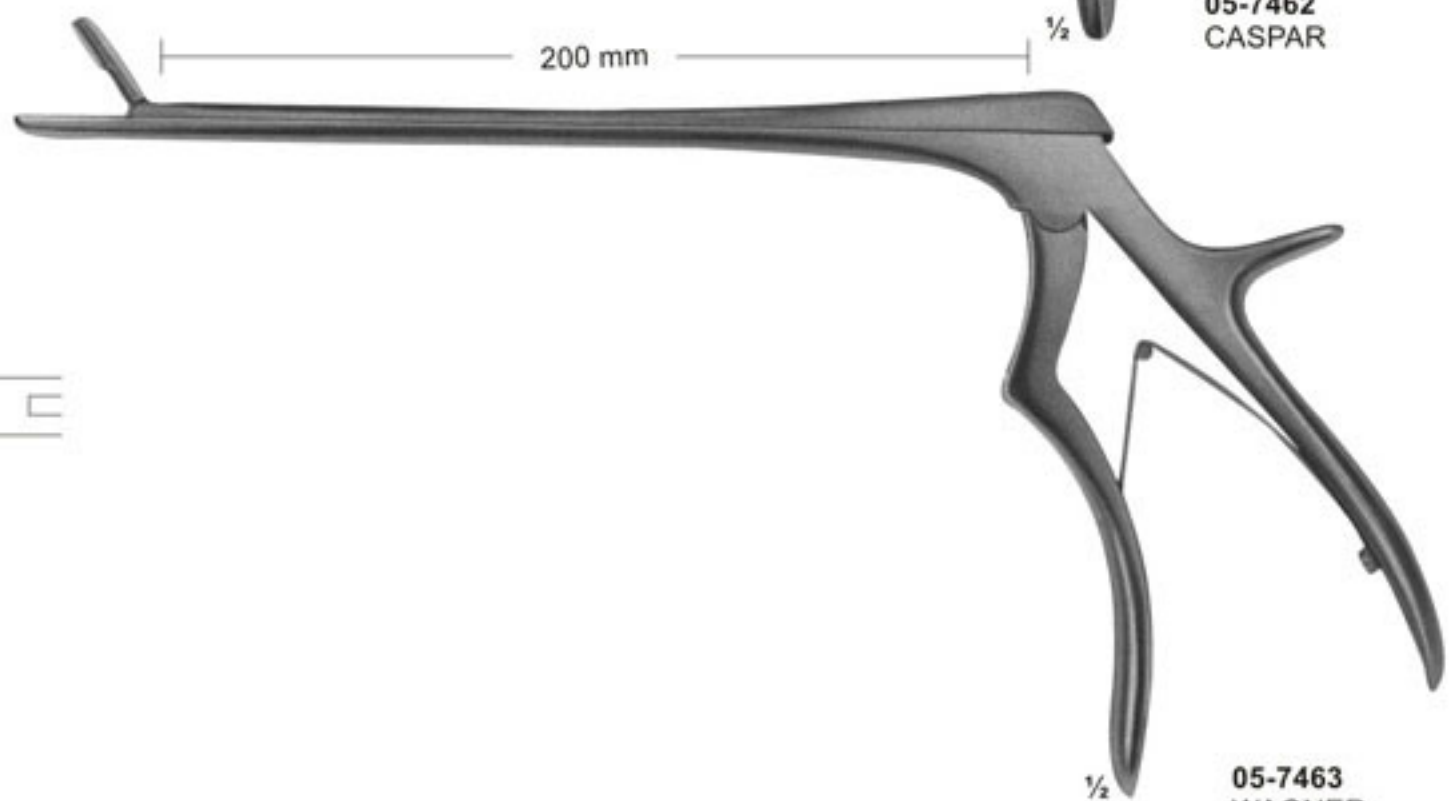

05-7463
WAGNER