

Section - 01



Pages 01 - 22

- ★ Diagnostic
- ★ Anaesthesia
- ★ Scalpels
- ★ Knives



Percussion Hammers & Aesthesiometers





Stethoscopes



01-2010
PINARD
of aluminium
Size: 155 mm

½



01-2011
aus Holz
Wooden
Size: 145 mm

½



01-2012
BOWLES
Stethoscope With
Diaphragm,
In Plastic Pouch

¼



01-2013
ANESTOPHON
Ø47mm

½



01-2014
FORD-BOWLES
Combination Stethoscope
With Diaphragm and Bell
Dual Chest Piece
With Two Outlets



¼

01-2015
BOWLES
Stethoscope With
Diaphragm,
Flat Model,
Suitable Also
For Anaesthesia
Chest Piece Only
40 mm Diam

¼





Head Mirrors & Head Bands



01-2016
ZIEGLER Ø 90mm
Head mirror only
with rubber coating

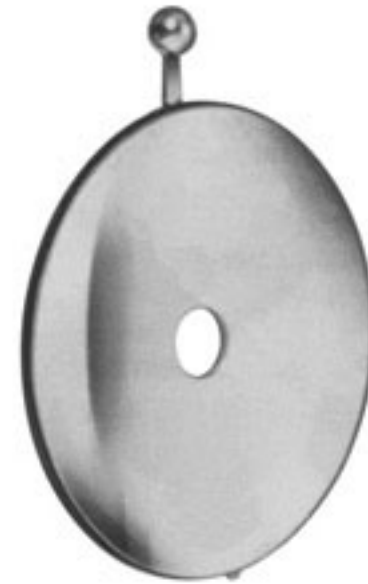

01-2017
ZIEGLER Ø 90mm
Head mirror only
with metal coating



01-2018
ZIEGLER
Head band of plastic, black only

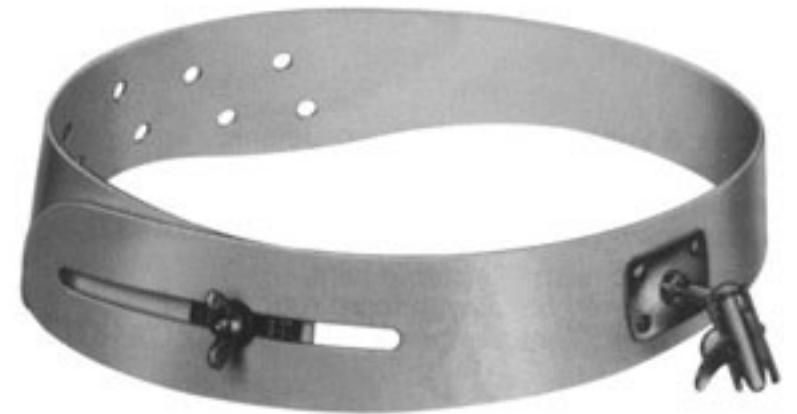

01-2020
MURPHY
Head band of celluloid, white only

01-2019
ZIEGLER
Head band of plastic, white only



01-2021
Head band of plastic,
white, soft pattern



01-2022
Head mirror
with black plastic head
band



Head Lights



01-2026
spare bulb

01-2023
CLAR
Head light, 6 volt, with adjustable joint,
white celluloid head band,
cord with plugs for transformer

01-2024
White celluloid head band, only, for **01-2023**

01-2025
Spare mirror only, for **01-2023**



01-2031
spare bulb

01-2027
CLAR
Head light, 6 volt, with adjustable joint,
white celluloid head band, with foam rubber pad
and cord with plugs for transformer

01-2028
White celluloid head band, only, for head light

01-2029
mirror only, for head light

01-2030
spare foam rubber pad, for head band



01-2033
spare bulb

01-2032
JANSEN
Head light, 6 volt, with adjustable joint,
white plastic head band,
cord with plugs for transformer



01-2035
spare bulb

01-2034
LANGENBECK
Head light, 3.7 volt, with
adjustable joint,
white plastic head band,
cord with plugs for
transformer



01-2036
HERBERHOLD
Pocket-Accu, 6 volts, with cord for head lights



01-2037
Extension cord only, to connect
the accu to the cord of the head lights



01-2038
Charging Set for pocket
accu **01-2036**
mains current: 220-240
volts, 50-60 Hz



01-2039
220 volt / 220 volts
01-2040
120 volt / 120 volts
Transformer



Tongue Depressors, Retractors

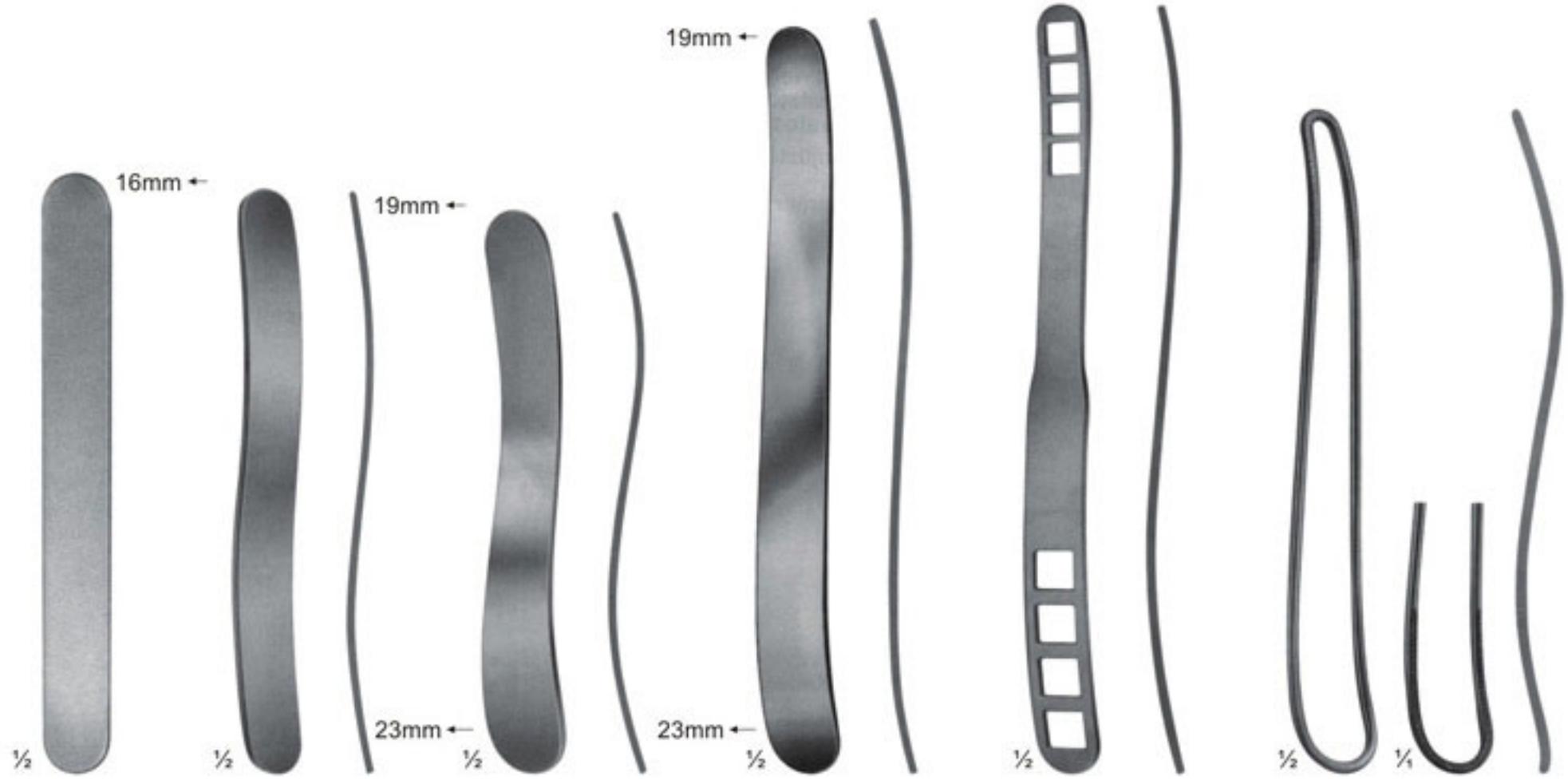

01-2041
Size: 150 mm

01-2042
Size: 145 mm

01-2043
Size: 140 mm

01-2044
BUCHWALD
Size: 180 mm

01-2045
BRUENINGS
Size: 190 mm

01-2046
FRENZEL
Size: 165 mm

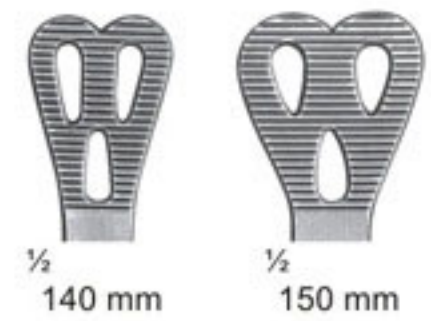

$\frac{1}{2}$
140 mm

$\frac{1}{2}$
150 mm



$\frac{1}{2}$
01-2047
SIMPLEX
Cheek and
Lipretractor
Size: 110 mm



01-2048-01-2050
STERNBERG
Cheek and Lipretractor
01-2048 120mm
01-2049 140mm
01-2050 160mm



$\frac{1}{2}$
01-2051
TOBOLD
Tongue depressor
Size: 145 mm



$\frac{1}{2}$
01-2052
ANDREW
Tongue depressor
Size: 110 mm



$\frac{1}{2}$
01-2053-01-2054
WIEDER
Tongue depressor
01-2053 140mm
01-2054 150mm



Mouth Gags And Tongue Forceps



1/2
01-2055
SCHIMMELBUSCH
Ether Mask



1/2
01-2056
HEISTER
Mouth Gag
Size: 130 mm



1/2
01-2057
FERGUSON-ACKLAND
Mouth Gag
Size: 145 mm



1/2
01-2058
DENHARDT
Mouth Gag With
Silicon Inserts,
Interchangeable
Size: 125 mm



1/2
01-2059-01-2060
ROSER KOENIG
Mouth Gag
Size: **01-2059** 160mm
01-2060 185mm

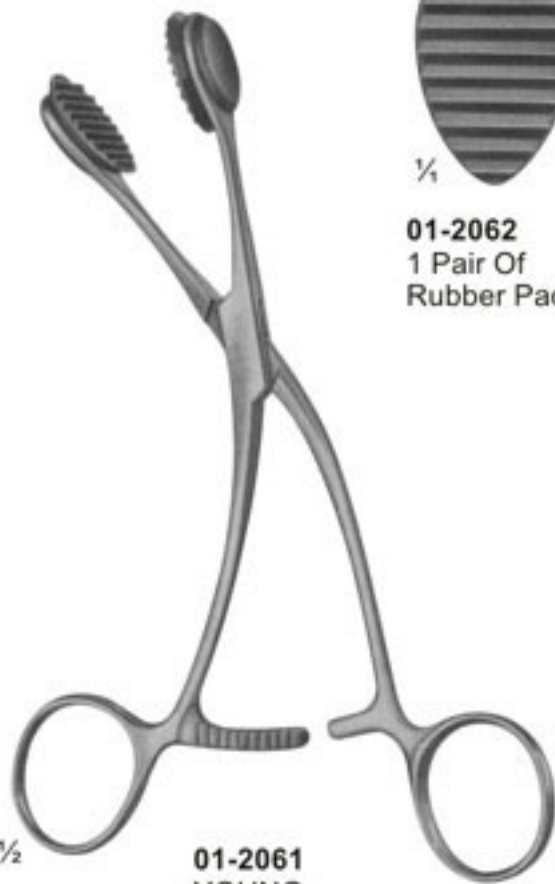

1/2
01-2061
YOUNG
Size: 165 mm



1/4
01-2062
1 Pair Of
Rubber Pads



1/2
01-2063-2064
COLLIN



1/4
01-2063
Size: 160 mm



1/4
01-2064
Size: 170 mm

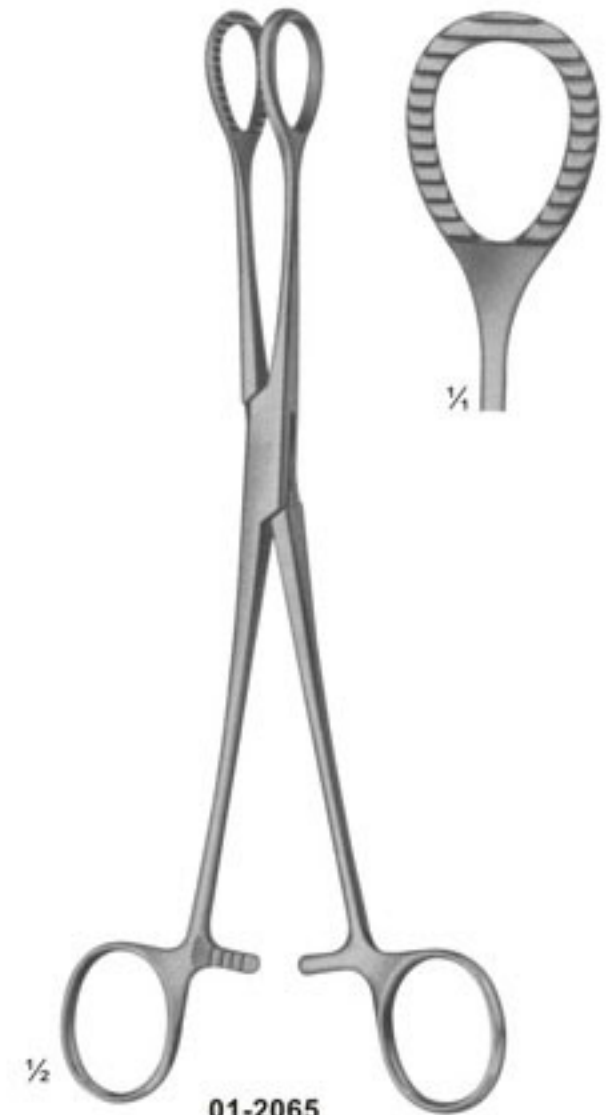

1/2
01-2065
HEYWOOD-SMITH modif.
Size: 215 mm



Blood Lancets & Laryngeal Mirrors



01-2067
Ø 12 mm
Spare Mirrors Only



01-2068
Ø 14 mm
Spare Mirrors Only

1/2

01-2066
MICHEL
Rhinoscopic Mirrors
With Interchangeable
Mirror Inserts
Size: 250 mm



1/2

01-2069
Mirror Handle
Size: 110 mm



1/2

01-2070
Mirror Handle
Size: 105 mm



1/2

01-2071
FRANCKE
Automatic
Blood Lancet



01-2072
KOLLE
Microscopic
Needle Holder
With Plastic
Handle
Size: 240 mm



1/2

01-2073
Laryngeal Mirrors With
Hexagonal Handle
Size: 180 mm



Fig. 000
Ø 6mm



Fig. 00
Ø 8mm

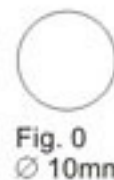

Fig. 0
Ø 10mm



Fig. 1
Ø 12mm

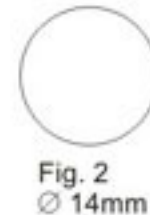

Fig. 2
Ø 14mm

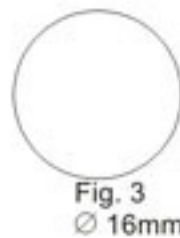

Fig. 3
Ø 16mm

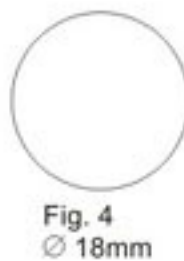

Fig. 4
Ø 18mm

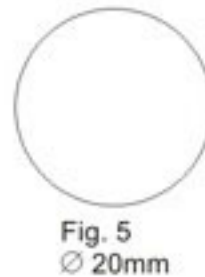

Fig. 5
Ø 20mm

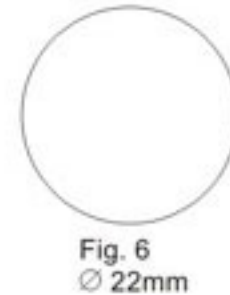

Fig. 6
Ø 22mm



Fig. 7
Ø 24mm

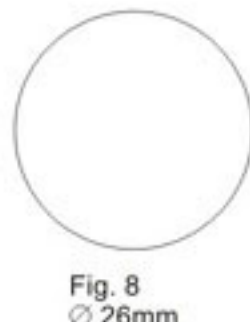

Fig. 8
Ø 26mm

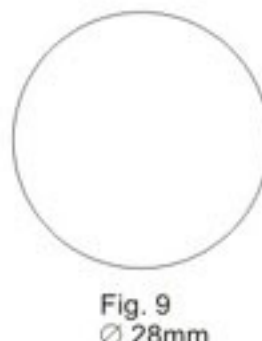

Fig. 9
Ø 28mm

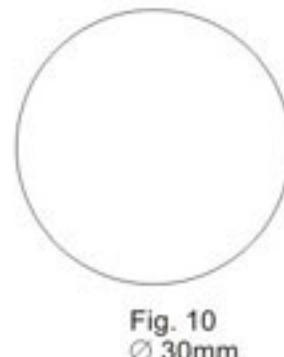

Fig. 10
Ø 30mm



Diagnostic Sets



1/2

01-2074 - 01-2076
MAGILL
Catheter Introducing
Forceps



01-2074
Infants
Size: 150 mm



01-2075
Children
Size: 200 mm



01-2076
Adults
Size: 250 mm



1/2

01-2077
Medium battery handle
only, 25 mm diam.



01-2078
Spare bulb
2.7 volt, for
Otoscopes etc.



01-2079
Spare bulb
2.6 volt, for
ophthalmoscopes



01-2080
Otoscope Set, Consists Of
Battery Handle Without Batteries,
3 Ear Specula, 1 Bulb In Velvet Lined Case



01-2081
Diagnostic Set, Otoscope With Three Specula,
Nasal Speculum, Lamp Holder, Two Laryngeal
Mirrors, Tongue Blade Holder



Laryngoscopes



1/2

01-2082
MILLER
 Laryngoscope Set, Consists Of Battery Handle (Without Battery)
 With Five Miller Laryngoscope Blades, Fig 1 to 5

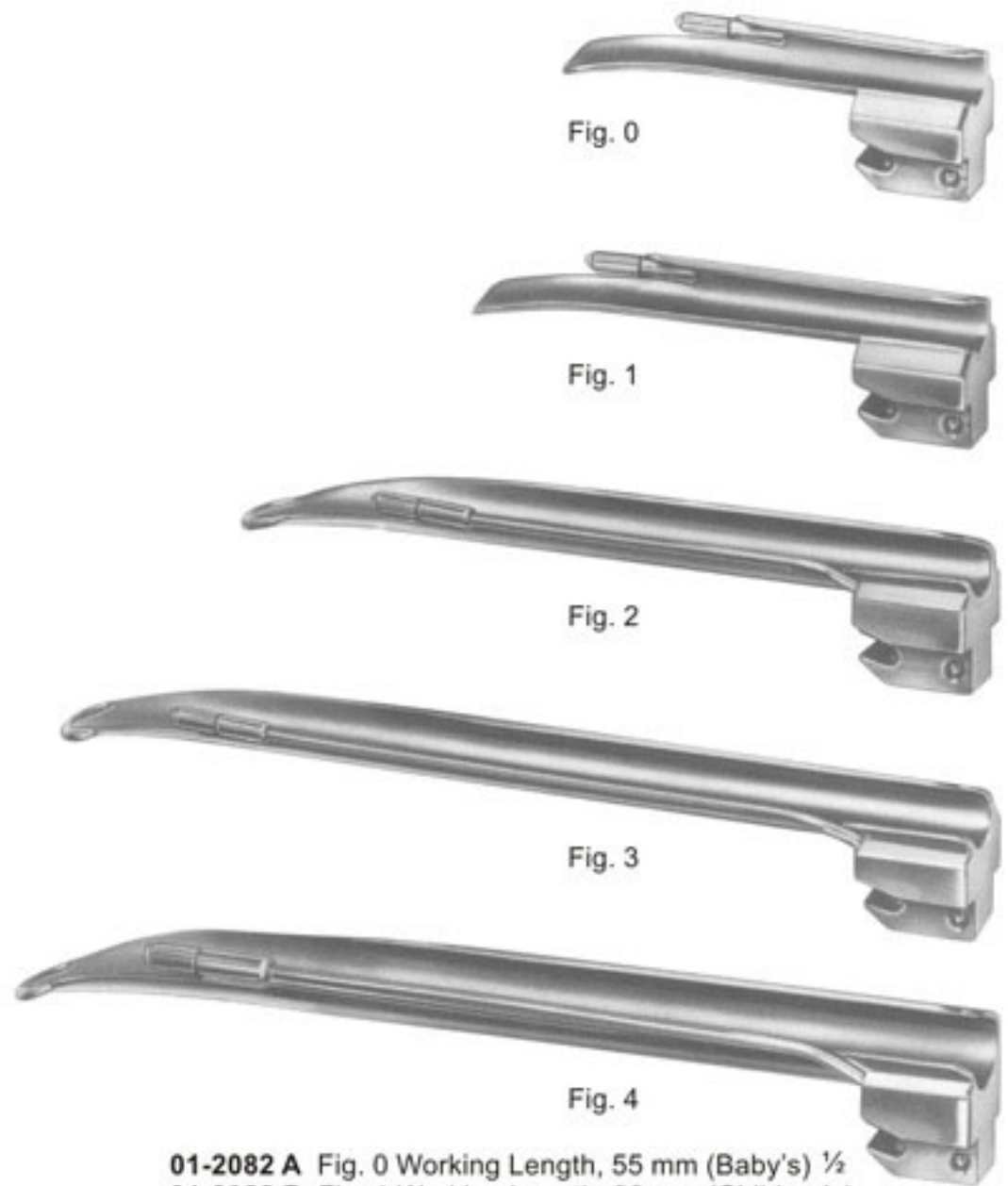

Fig. 0

Fig. 1

Fig. 2

Fig. 3

Fig. 4

- 01-2082 A Fig. 0 Working Length, 55 mm (Baby's) 1/2
- 01-2082 B Fig. 1 Working Length, 80 mm (Children's)
- 01-2082 C Fig. 2 Working Length, 130 mm (Adolescent's)
- 01-2082 D Fig. 3 Working Length, 170 mm (Women's)
- 01-2082 E Fig. 4 Working Length, 180 mm (Men's)



1/2

01-2083
GUEDEL-NEGUS
 Laryngoscope Set, Consists Of Battery Handle (Without Battery)
 With Four Miller Laryngoscope Blades

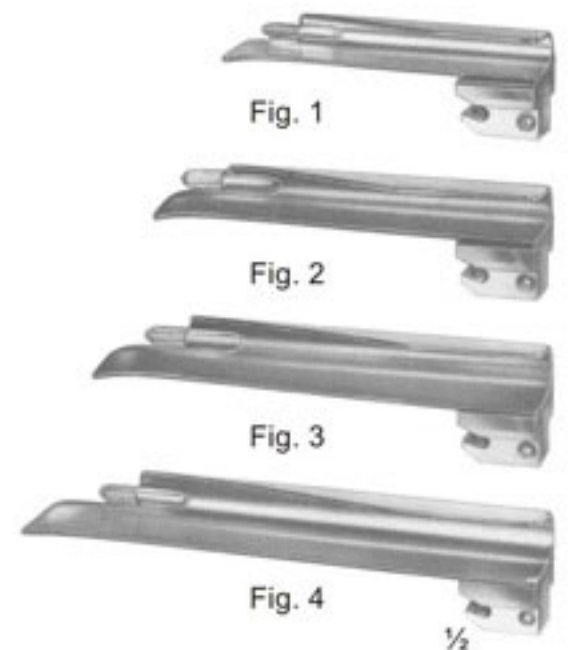

Fig. 1

Fig. 2

Fig. 3

Fig. 4

1/2

- 01-2083 A Fig. 1 Working Length, 70 mm (Children's)
- 01-2083 B Fig. 2 Working Length, 90 mm (Adolescent's)
- 01-2083 C Fig. 3 Working Length, 110 mm (Women's)
- 01-2083 D Fig. 4 Working Length, 135 mm (Men's)



Laryngoscopes



01-2084
McINTOSH
Laryngoscope Set, Consists Of Battery Handle (Without Battery)
With Three McIntosh Blades, Fig. 1, Fig. 2, Fig. 3

01-2085
McINTOSH
Laryngoscope Set, Consists Of Battery Handle (Without Battery)
With Five McIntosh Blades, Fig. 0, Fig. 1, Fig. 2, Fig. 3, Fig. 4



01-2086
FOREGGER
Laryngoscope Set, Consists Of
Battery Handle (Without Battery)
With Three Foregger Blades,
Fig. 1, Fig. 2, Fig. 3,

01-2087
FOREGGER
Laryngoscope Set, Consists Of
Battery Handle (Without Battery)
With Four Foregger Blades,
Fig. 1, Fig. 2, Fig. 3, Fig. 4,



01-2088
Fiber Optic
Battery Handle
30mm diam.



01-2089
Fiber Optic
Battery Handle
18mm diam.



01-2090
Replacement Lamp
(Krypton) 2.5 V

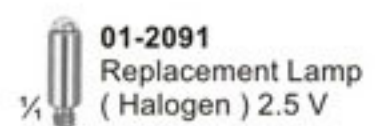

01-2091
Replacement Lamp
(Halogen) 2.5 V

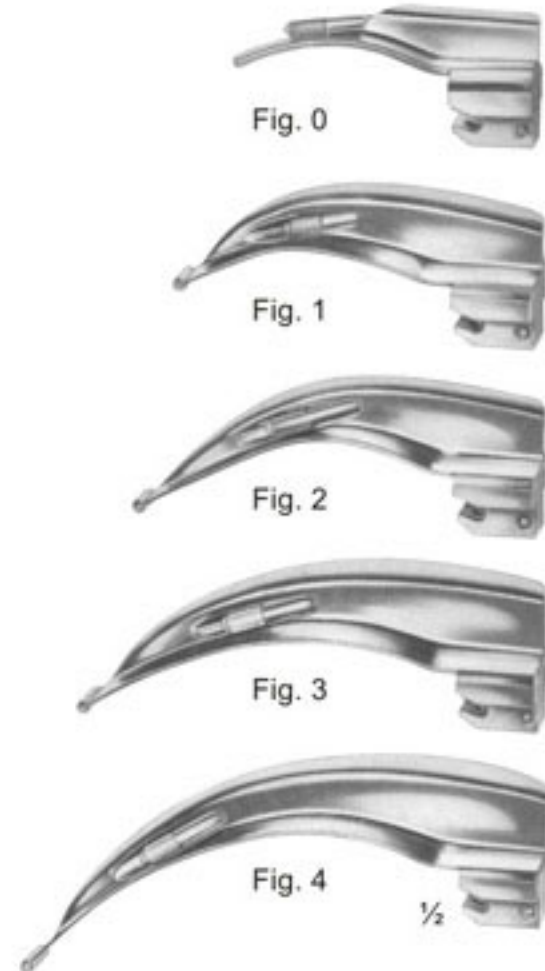

01-2085 A Fig. 0 Working Length, 55 mm (Baby's)
01-2085 B Fig. 1 Working Length, 75 mm (Children's)
01-2085 C Fig. 2 Working Length, 90 mm (Adolescent's)
01-2085 D Fig. 3 Working Length, 110 mm (Women's)
01-2085 E Fig. 4 Working Length, 135 mm (Men's)

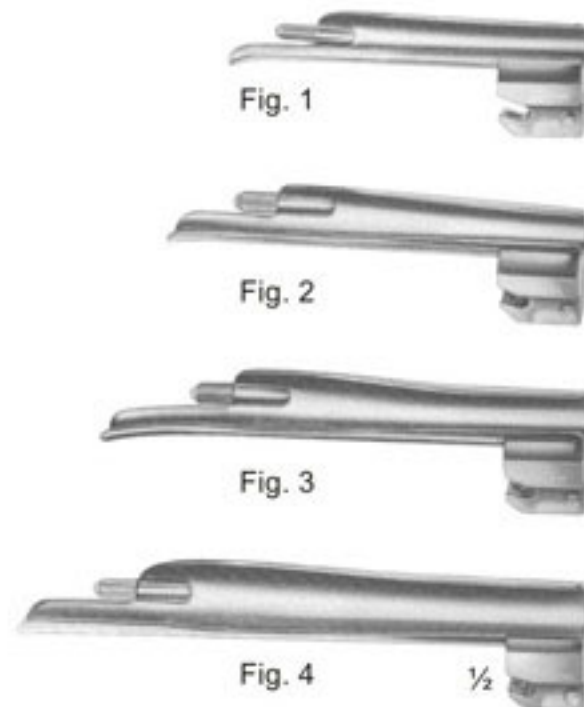

01-2086 A Fig. 1 Working Length, 70 mm (Children's)
01-2086 B Fig. 2 Working Length, 90 mm (Adolescent's)
01-2086 C Fig. 3 Working Length, 110 mm (Women's)
01-2086 D Fig. 4 Working Length, 135 mm (Men's)



Examination & Measuring Instruments

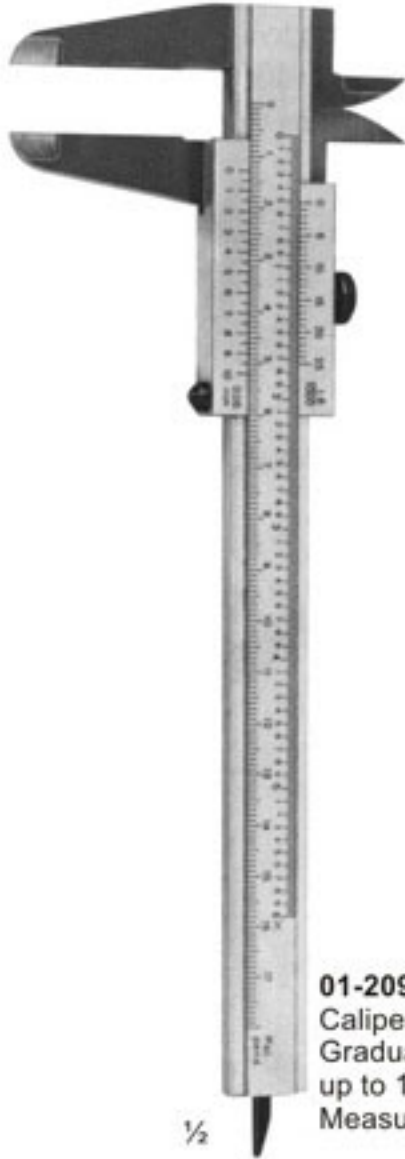

1/2

01-2092
Caliper Of Aluminium
Graduated in mm & inches
up to 180mm
Measuring Range up to 139mm



1/2

01-2093
VERNIER
Universal Caliper Of Steel
Graduated in mm & inches
up to 180mm
Measuring Range up to 120mm
with Vernier in 1/10mm & 1/16"



1/2

01-2094
CARROLL
Size: 145 mm
Finger Goniometer



1/2

01-2095
TOWNLEY
Graduated in
mm & inches
Size: 115 mm



1/2

01-2096
COLLIN
Druck Pressure 72 kg
Size: 125 mm



1/2

01-2097
BERTILLON
Caliper For Measuring The Head
Size: 320 mm



1/2

01-2098
CASTROVIEJO
Caliper
Size: 75mm



1/2

01-2099
MOLTGEN
Goniometer



01-2100A
Size: 150 mm

01-2100
Size: 500 mm



Dissecting Knives



01-2101
Fig. 1
Size: 30mm
15cm



01-2102
Fig. 2
Size: 36mm
15cm



01-2103
Fig. 3
Size: 40mm
15.5cm



01-2104
Fig. 4
Size: 45mm
16cm



01-2105
Fig. 5
Size: 50mm
16cm



01-2106
Fig. 6
Size: 27mm
15cm



01-2107
Fig. 7
Size: 35mm
15cm



01-2108
Fig. 8
Size: 40mm
16cm



01-2109
Fig. 9
Size: 47mm
16cm



01-2110
Fig. 10
Size: 50mm
17cm

01-2101 - 01-2110
Fig. 1 - 10
With Metal Handle



Autopsy & Cartilage Knives

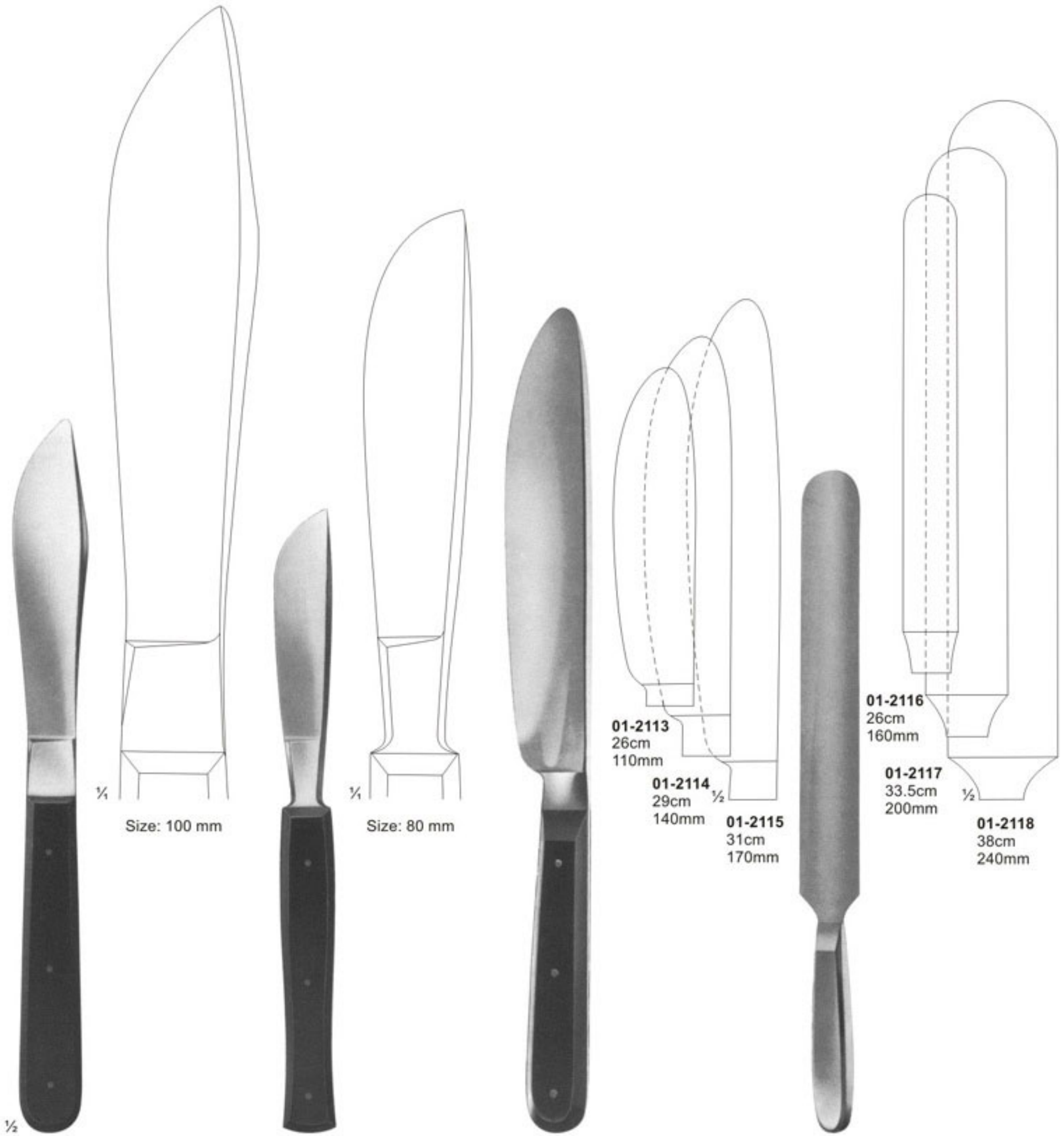

1/2
01-2111
Size: 255 mm
wooden handle.

1/4
Size: 100 mm

01-2112
210mm
with wooden handle

1/4
Size: 80 mm

01-2113 - 01-2115
WALB
with wooden handle

01-2113
26cm
110mm
01-2114
29cm
140mm
01-2115
31cm
170mm

01-2116 - 01-2118
VIRCHOW
with hollow handle

01-2116
26cm
160mm
01-2117
33.5cm
200mm
01-2118
38cm
240mm



Scalpels, Tenotomes & Resection Knives

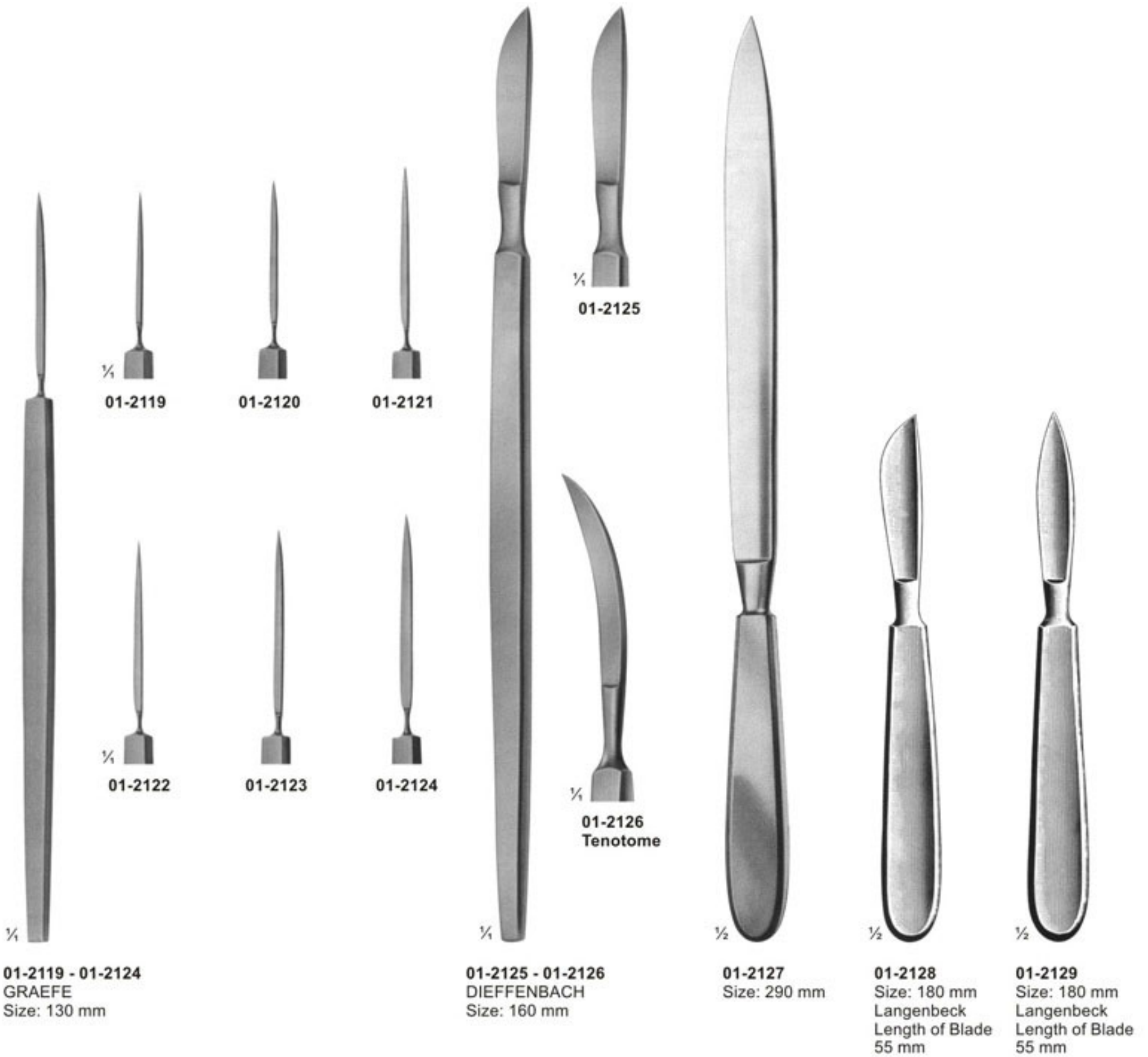



Scalpels, Tenotomes

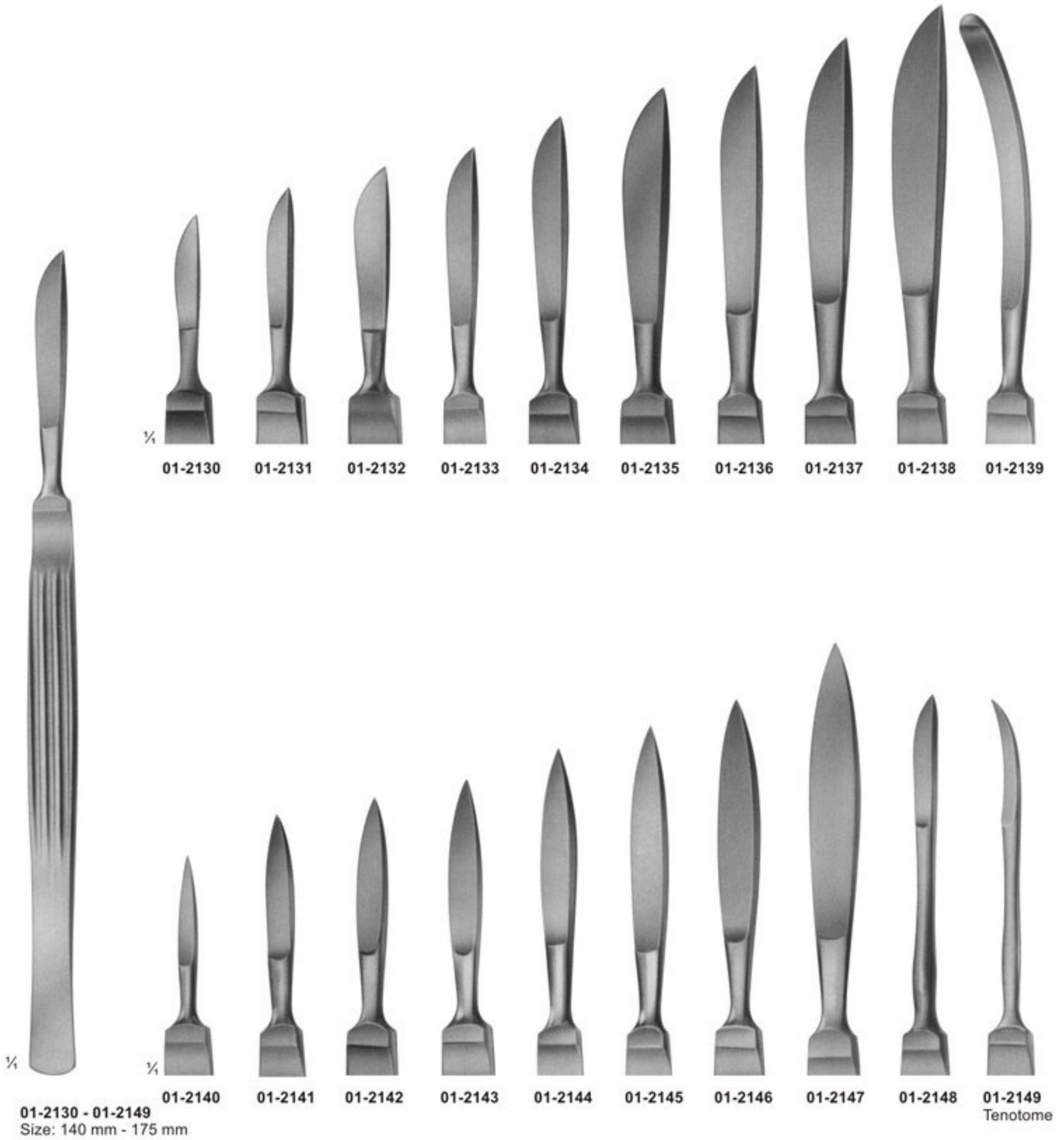

01-2130 - 01-2149
Size: 140 mm - 175 mm

01-2149
Tenotome



Amputating Knives, Cartilage Knives, Autopsy Knives

Double Cutting

Double Cutting



LISTON
01-2150
Size: 130 mm
01-2151
Size: 160 mm
01-2152
Size: 190 mm
01-2153
Size: 220 mm

Blade Length
Amputating Knives

01-2154
CATLIN
Size: 160 mm
Blade Length
Amputating
Knives

01-2155
LANGENBECK
Size: 120 mm
Blade Length
Flap Knives

01-2156
Size: 110 mm
Blade Length
Interosseous
Knives

01-2157
Size: 55 mm
Blade Length
With Raspatory,
Wooden Handle

01-2158
Size: 70 mm
Blade Length
Wooden Handle

01-2159
Size: 80 mm
Blade Length
Metal Handle

01-2160
Size: 195 mm
Blade Length
Metal Handle



Cone Knives, Myomatome, Trigeminal & Tonsil Knives



01-2161
AYRE
Size: 235 mm
Cone Knife

01-2162
Size: 230 mm
Cone Knife

01-2163
SEGOND
Size: 270 mm
Myomatome

01-2164
OLIVECRONA
Size: 205 mm
Trigeminal
Knife

01-2165
Size: 230 mm
Trigeminal
Knife

01-2166
FOWLER
Size: 200 mm
Tonsil Knife

01-2167
ABRAHAM
Size: 215 mm
Tonsil Knife

01-2168
BRUENINGS
Size: 215 mm
Tonsil Knife



Scalpels, Dura Knives & Comedone Extractors



1/4

01-2169 - 01-2170
JOSEPH
Size: 145 mm

Double Edged
Nasal Knives, Pointed



1/4

01-2169
Straight



1/4

01-2170
Curved



1/4

01-2171 - 01-2173
ZIEGLER
Size: 120 mm
Milium Knives



1/4

01-2171
Small



01-2172
Large



01-2173
Pointed



1/2

01-2174
VIDAL
Lupus Scraper
Size: 135 mm

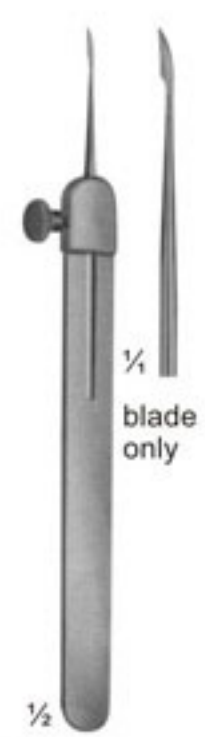

1/2

01-2175
MONCORPS
Milium Knives
Size: 130 mm

blade only



1/2

1/4

01-2176
SAALFELD
Size: 100 mm

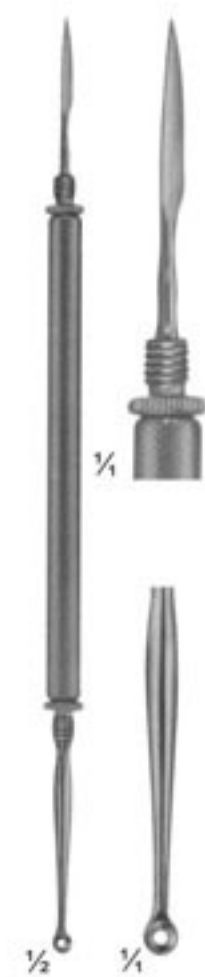

1/2

1/4

01-2177
HEBRA
Size: 180 mm



1/2

01-2178
Size: 145 mm



1/2

1/4

01-2179
UNNA
Size: 145 mm



Razor Blade Holders & Breakers



01-2180
TROUTMAN-CHRIS
Size: 90 mm
Handle Diameter 5.5 mm



01-2181
TROUTMAN-CHRIS
Size: 90 mm
Handle Diameter 5.5 mm



01-2182
Size: 110 mm



01-2183
CASTROVIEJO
Size: 130 mm
Handle Diameter 8 mm



01-2184
Size: 185 mm
Razor Blade
Breaker & Holder,
Straight



Scalpel Handles



¼
01-2185
STANDARD
No. 4
Solid

¼
01-2186
Double Handle
No. 4 + No. 3
Solid

¼
01-2187
No. 4 L
Straight
Solid

¼
01-2188
No. 4 L
Solid Angled

¼
01-2189
COLLIN
No. 8
Hollow

¼
01-2190
COLLIN
No. 9
Hollow

¼
01-2191
Plastic
No.4



Scalpel Handles

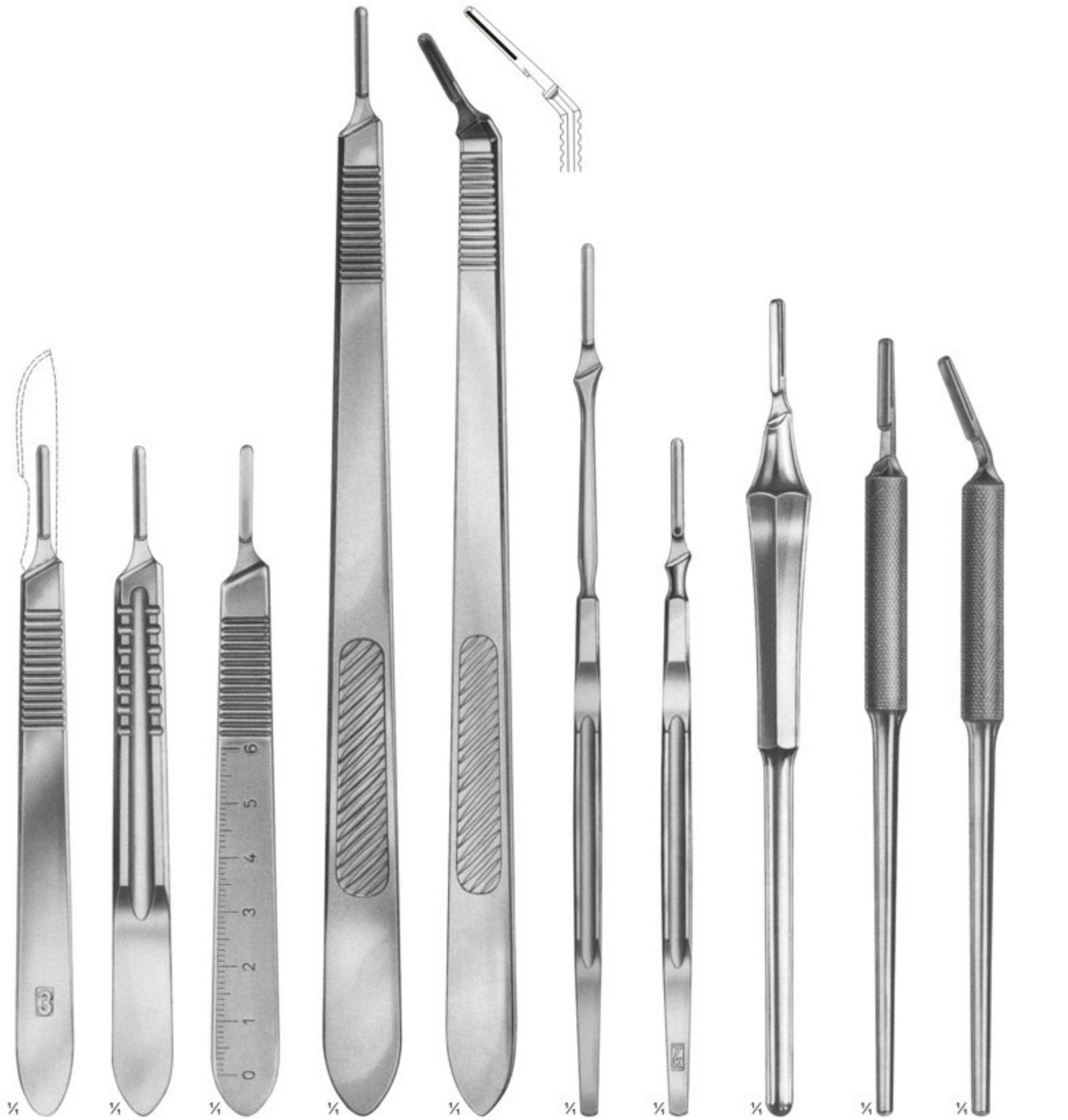

01-2192
STANDARD
No. 3
Solid
Size:12cm

01-2193
No. 3
Solid
Size:12cm
solid handle
style as
No.4

01-2194
No. 3
Solid
Size:12cm
cm-graduation

01-2195
No. 3 L
Straight
Solid, long
Size:21.5cm

01-2196
No. 3 L
Angled
Solid, long
Size:21cm

01-2197
No. 7
Solid
Size:16cm

01-2198
No. 7 K
Solid, short
Size:12.5cm

01-2199
No.3
Size:15.5cm
with round
hollow handle

01-2200
No. 3
Straight
Solid,
Round
Size:14.5cm

01-2201
No. 3
Angled
Solid, Round
Size:14cm



Razors & Dermatomes



1/2

01-2202
SCHINK
Size: 310 mm
Complete with 2
skin fixing plates
and 1 blade.
Adjustable from
0.1 to 2.0mm



1/2

01-2203
SCHINK
Spare Blade

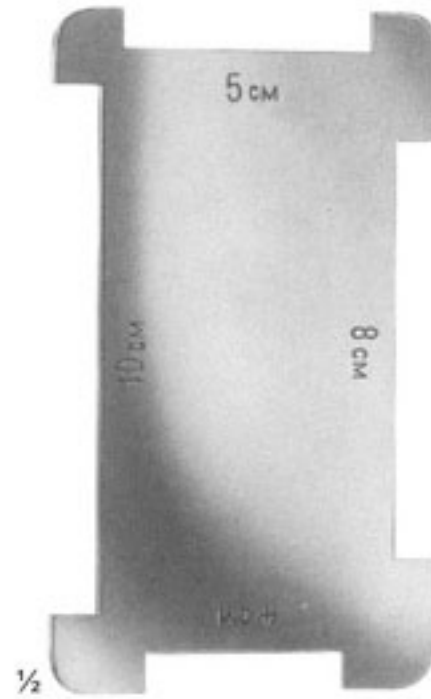

1/2

01-2204
SCHINK
Skin Fixing Plate



1/2

01-2205
SILVER
Size: 190 mm
For Usual
Razor Blades



1/2

01-2206
Size: 75 mm
Cutting Length



1/2

01-2207
Size: 80 mm
Cutting Length