

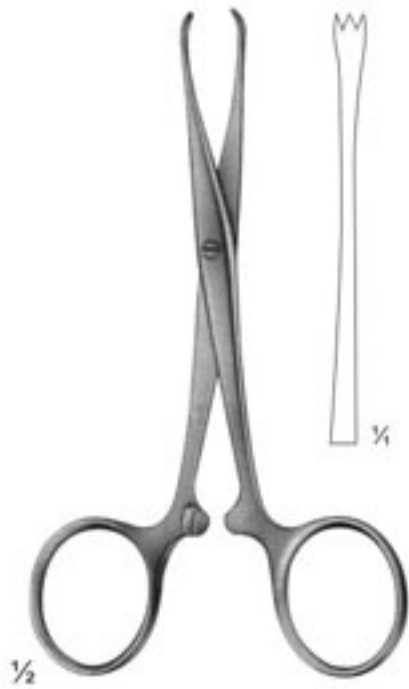

Intestinal and Tissue Grasping Forceps

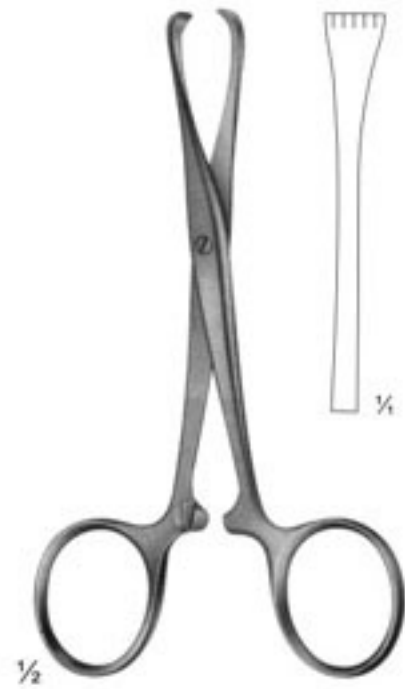

03-5473
CHAPUT
2 X 3 teeth, sharp
125 mm,



03-5474
TUFFIER
5 X 6 teeth, sharp
125 mm,



03-5475
BOYS-ALLIS
5 X 6 teeth, sharp
155 mm,

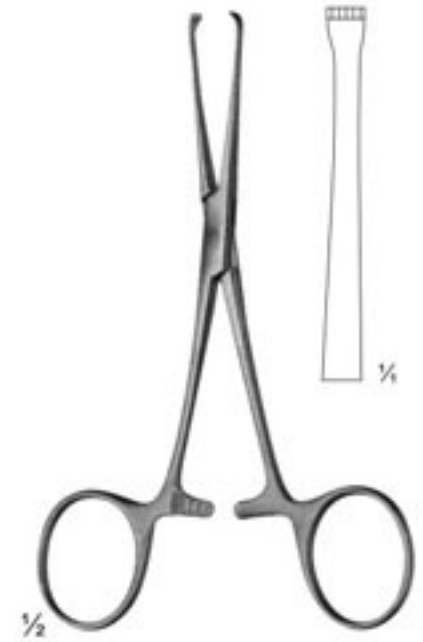

03-5476
BABY-ALLIS
4 X 5 teeth
130mm

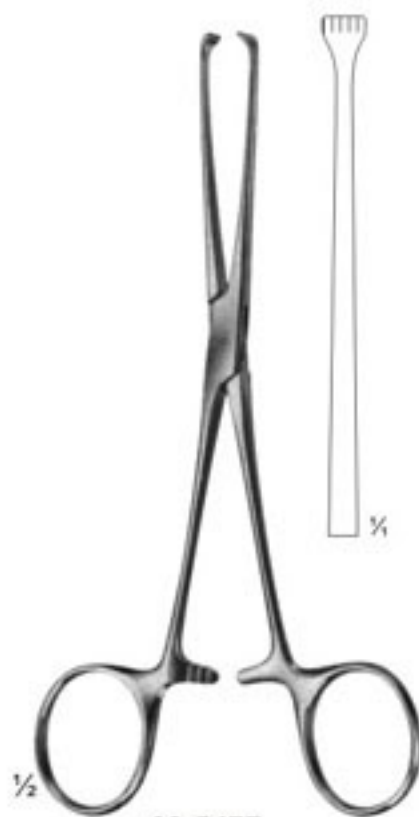

03-5477
ALLIS
4 X 5 teeth
155 mm,

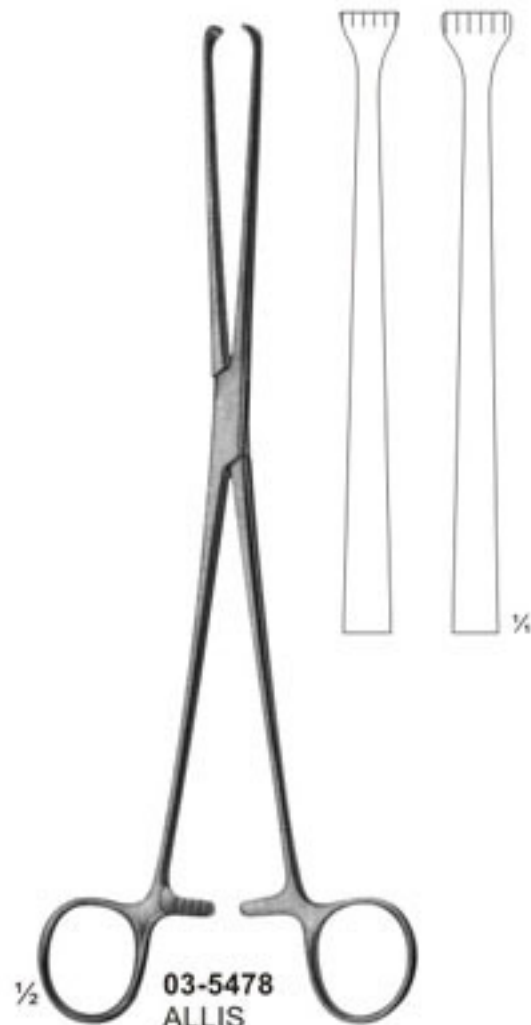

03-5478
ALLIS
190 mm,
03-5479
255 mm,
5 X 6 teeth
Slender pattern



03-5480
JUDD-ALLIS
3 X 4 teeth
195 mm,



Intestinal Grasping Forceps

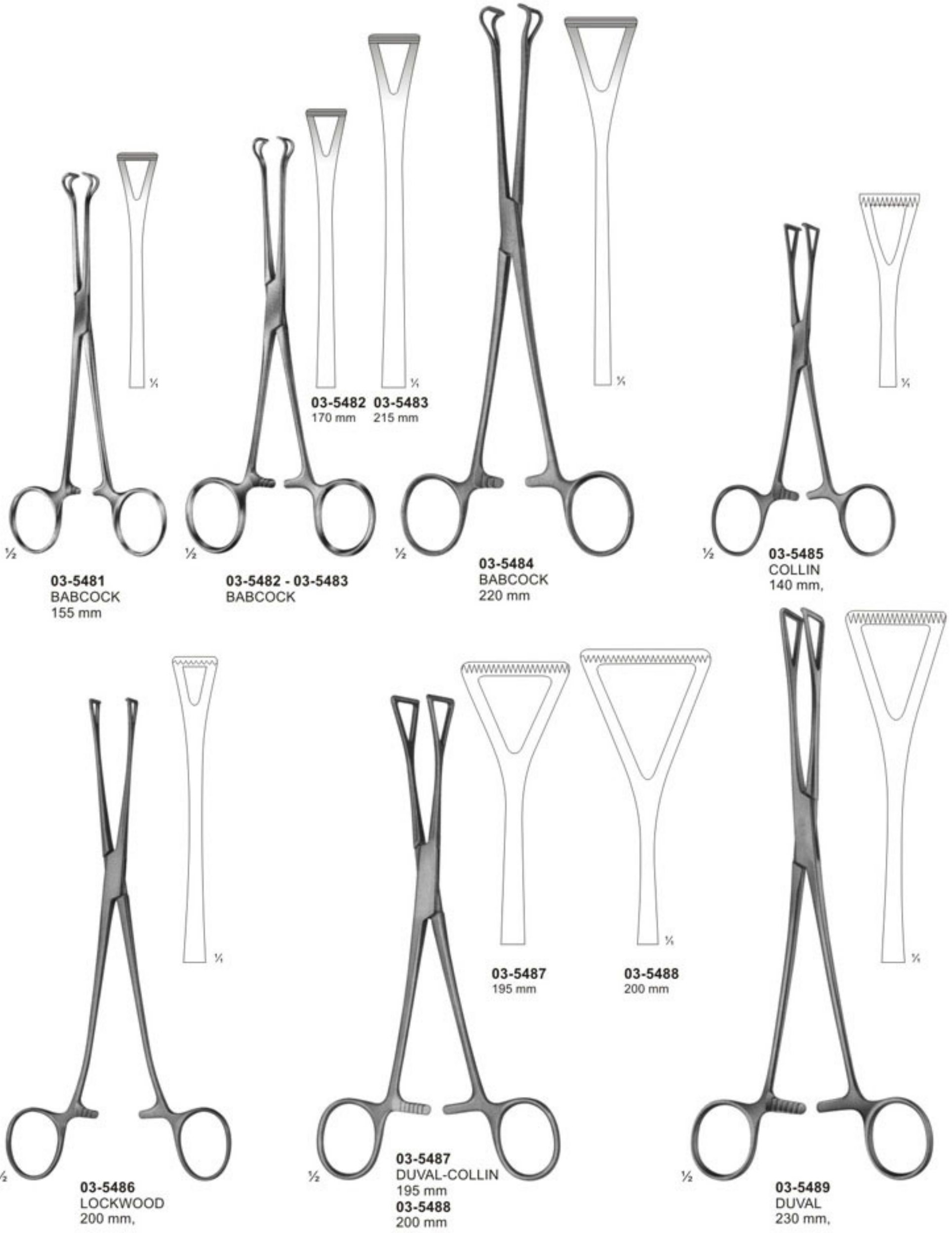

$\frac{1}{2}$
03-5481
BABCOCK
155 mm

$\frac{1}{2}$ $\frac{1}{4}$
03-5482 - 03-5483
BABCOCK
170 mm 215 mm

$\frac{1}{2}$ $\frac{1}{4}$
03-5484
BABCOCK
220 mm

$\frac{1}{2}$ $\frac{1}{4}$
03-5485
COLLIN
140 mm,

$\frac{1}{2}$ $\frac{1}{4}$
03-5486
LOCKWOOD
200 mm,

$\frac{1}{2}$ $\frac{1}{4}$
03-5487
DUVAL-COLLIN
195 mm
03-5488
200 mm

$\frac{1}{2}$ $\frac{1}{4}$
03-5489
DUVAL
230 mm,



Organ - Tissue Grasping, Intestinal and Dissecting Forceps



03-5490 130 mm
03-5491 155 mm
03-5492 195 mm

03-5490 - 03-5492
 LANE

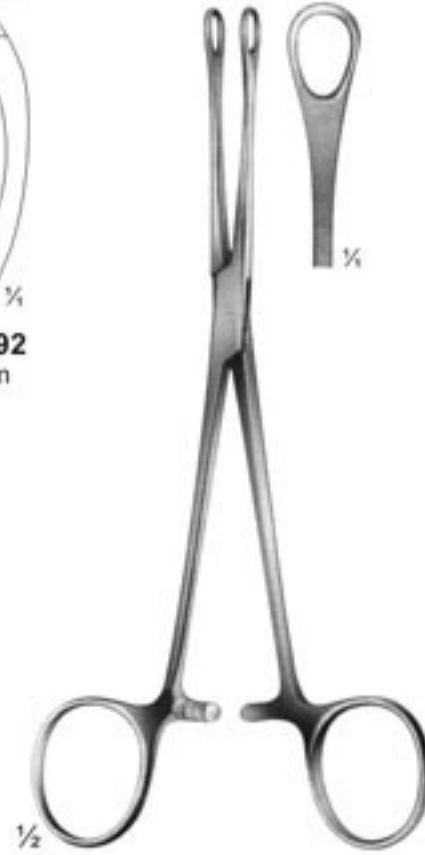

03-5493
 WILLIAMS
 160 mm



03-5494
 DENIS
 BROWNE
 190 mm



03-5495
 DUVAL
 140 mm



03-5496 **03-5497**
 DUROGRIP

03-5496 - 03-5497
 WANGENSTEEN
03-5496 150 mm
03-5497 230 mm

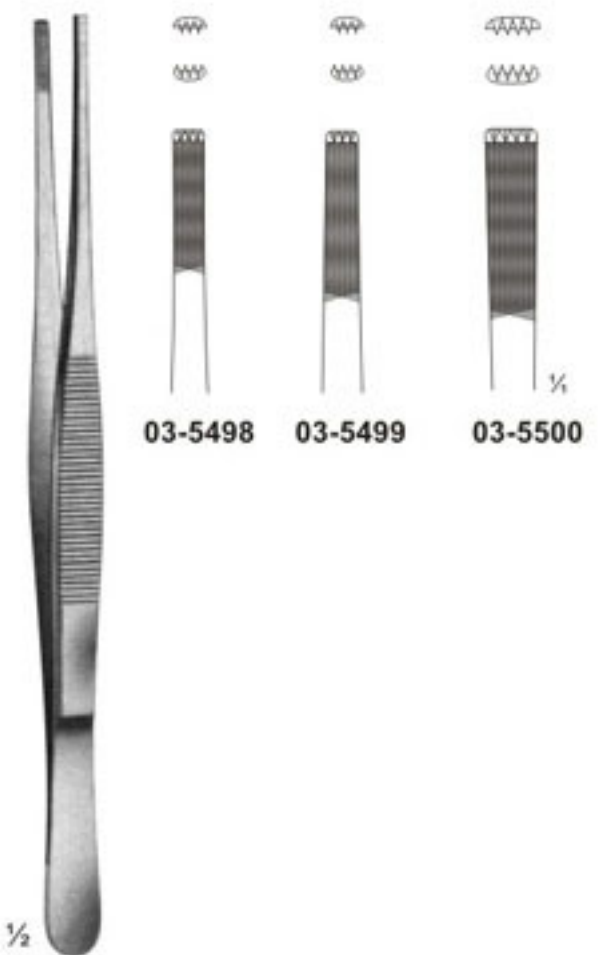

03-5498 - 03-5500
 STILLE-BARRAYA
03-5498 180mm
03-5499 200mm
03-5500 250mm



Organ - Tissue Grasping & Intestinal Forceps ATRAUMATA

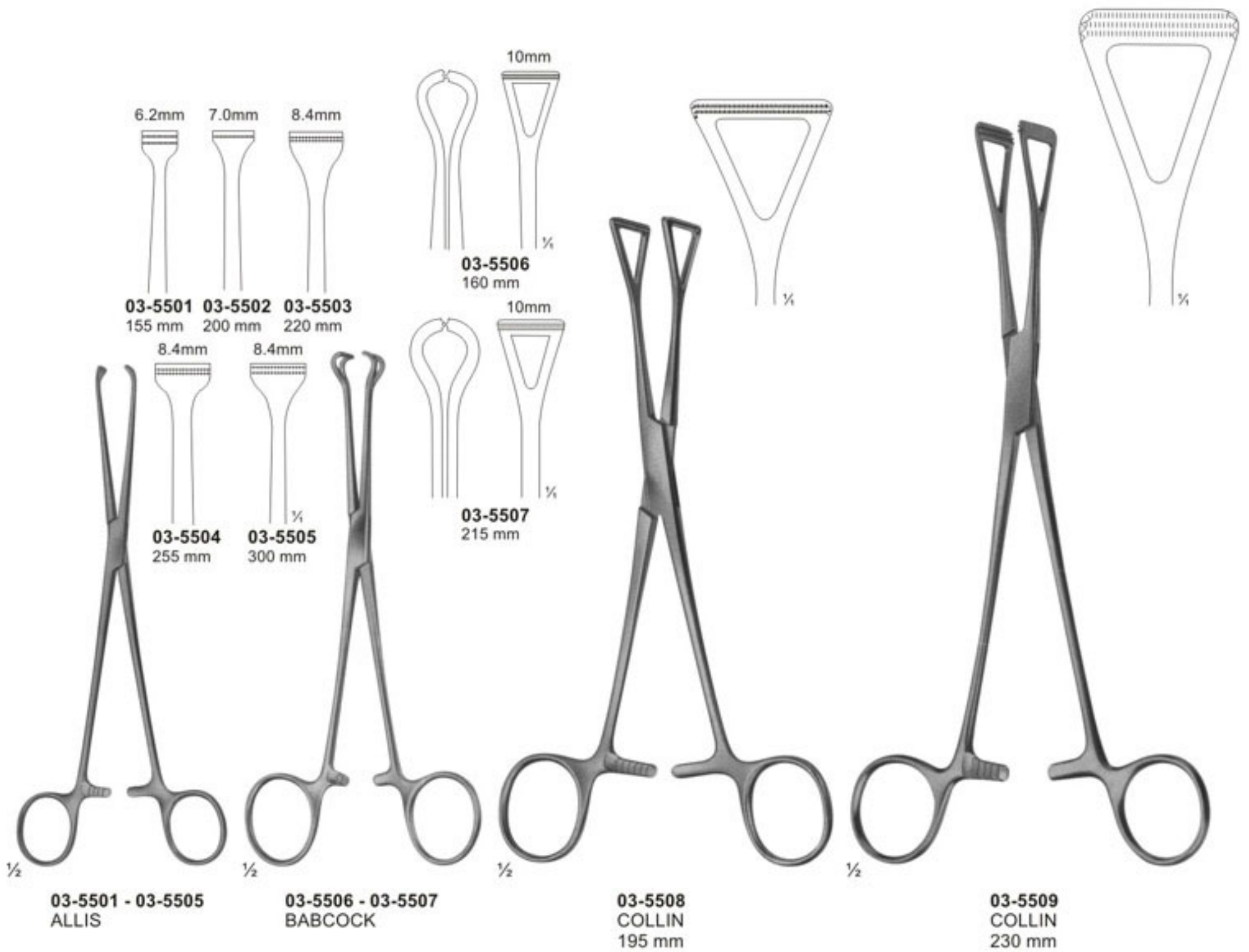



Ultra - Light - Forceps, Dissecting Forceps ATRAUMATA

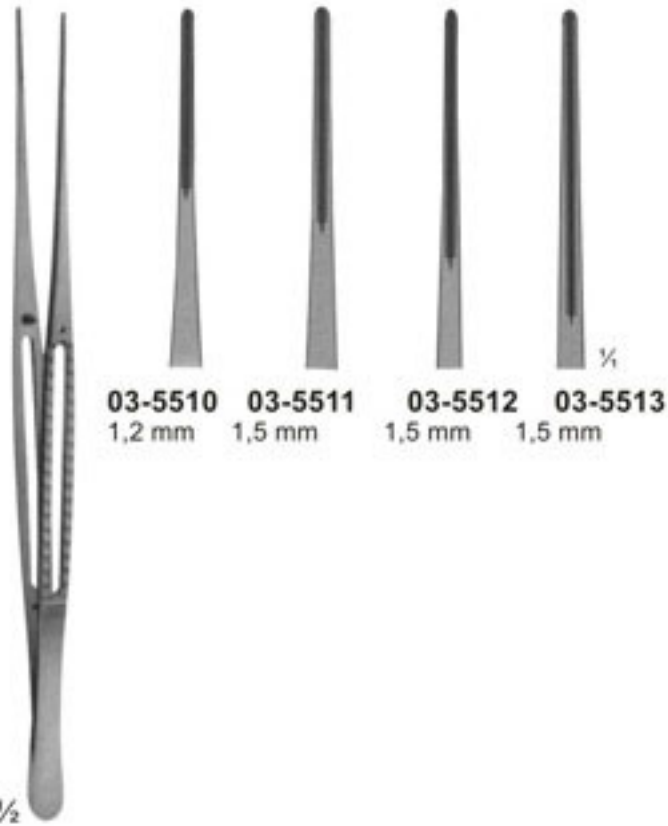

03-5510 - 03-5513
03-5510 150 mm
03-5511 200 mm
03-5512 240 mm
03-5513 300 mm



03-5514 - 03-5517
DE BAKEY
03-5514 150 mm
03-5515 200 mm
03-5516 240 mm
03-5517 300 mm

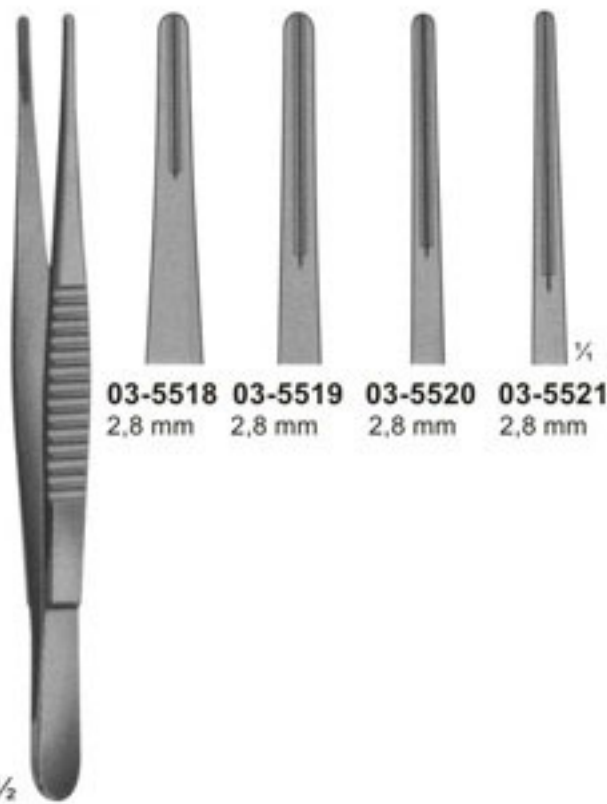

03-5518 - 03-5521
DE BAKEY
03-5518 150 mm
03-5519 200 mm
03-5520 240 mm
03-5521 300 mm



03-5522 - 03-5524
DE BAKEY
03-5522 200 mm
03-5523 240 mm
03-5524 300 mm



Intestinal Clamps for Children



03-5525 - 03-5526
BAINBRIDGE
155 mm



03-5527
ALLEN
155 mm

Atraumata



03-5528 - 03-5529
BABY-KOCHER
very elastic blades
130 mm

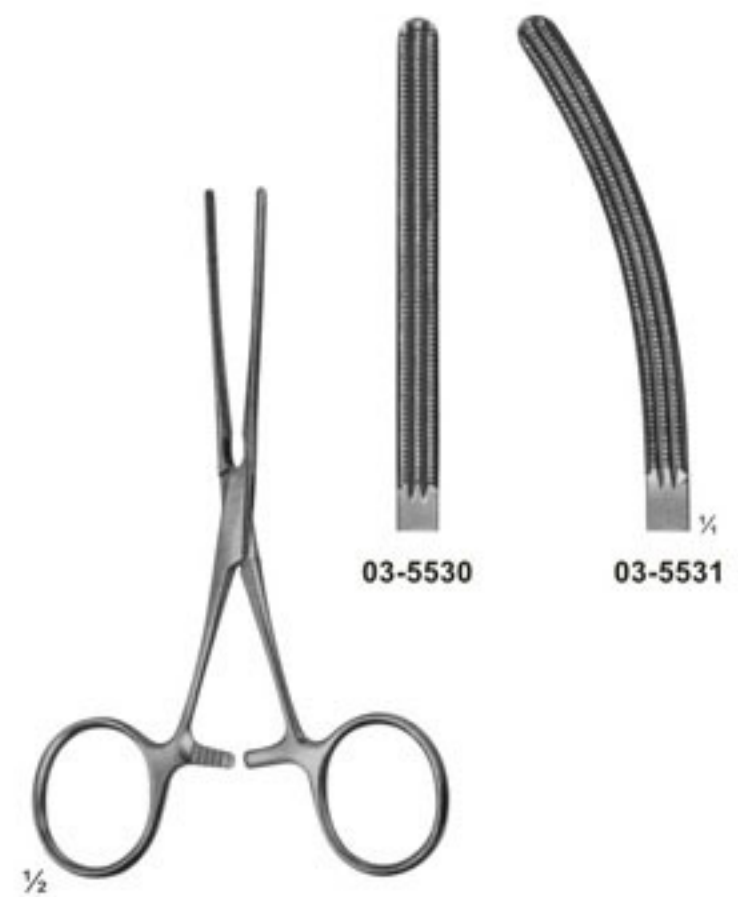

03-5530 - 03-5531
BABY-KOCHER
with elastic blades
130 mm



Intestinal Clamps, Soft Elastic

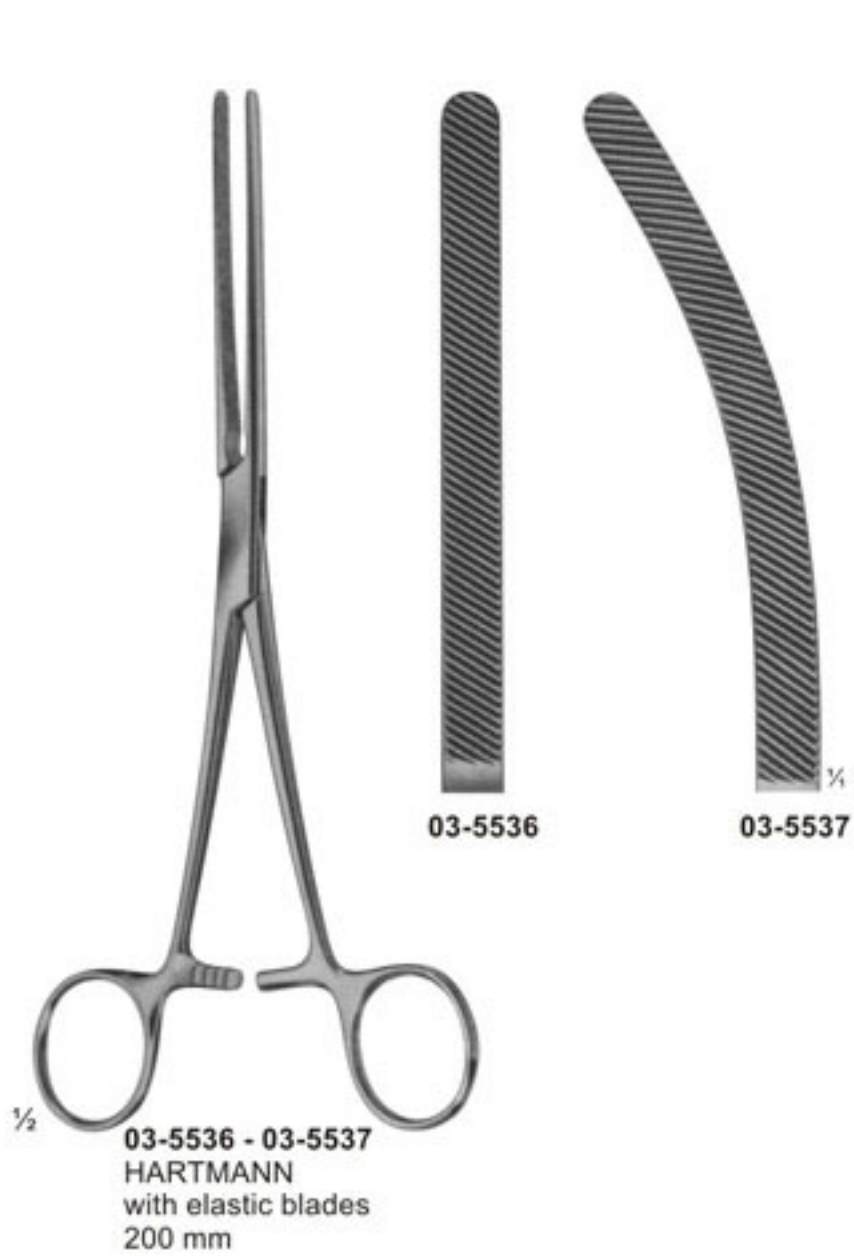
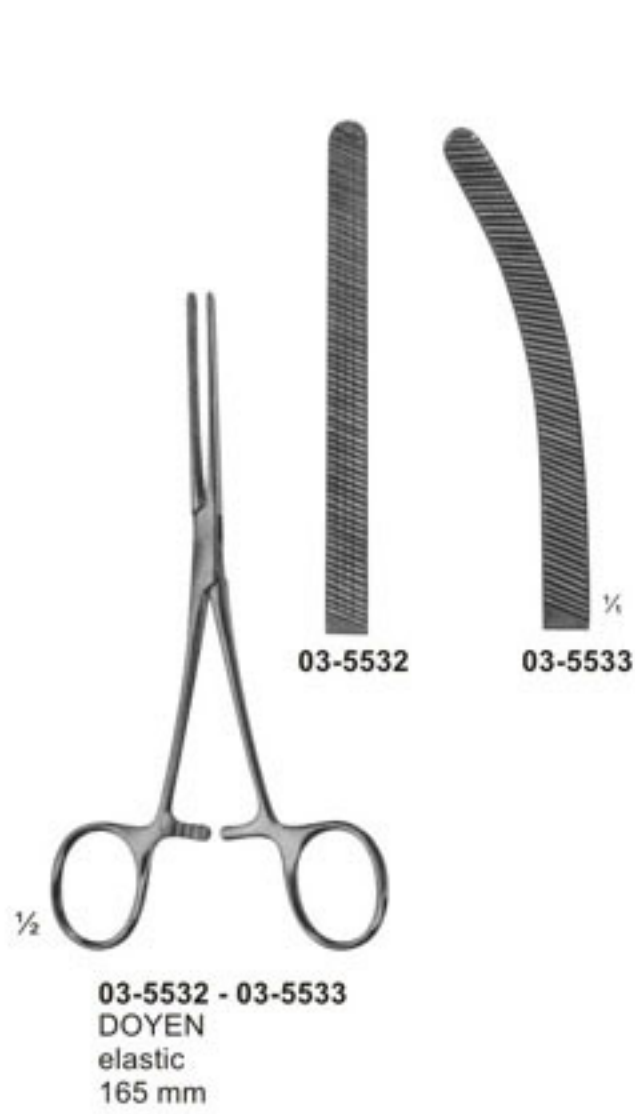



Intestinal Clamps, Soft elastic

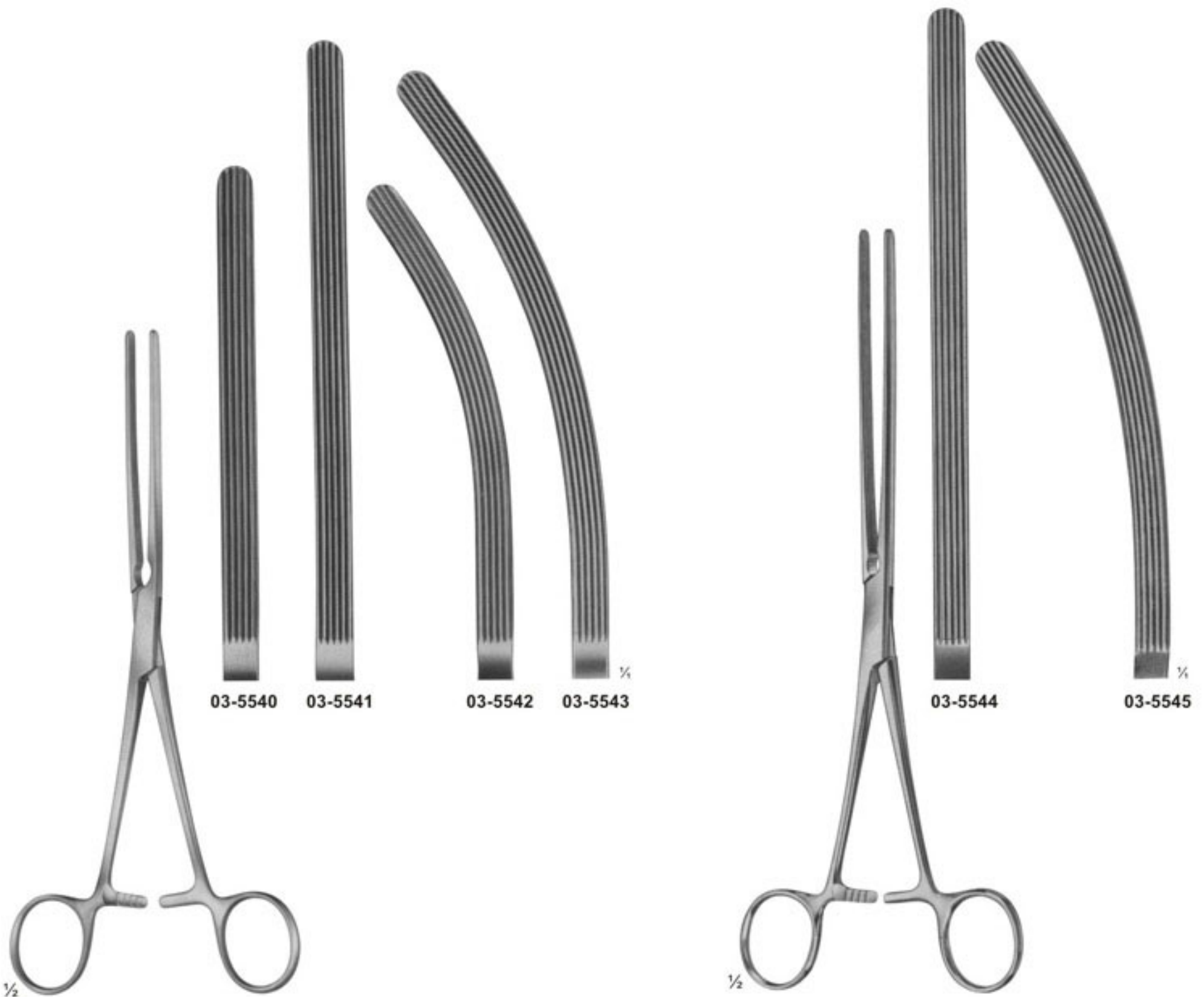

03-5540 - 03-5543
KOCHER
with elastic blades
03-5540-03-5542 210 mm
03-5541-03-5543 230 mm

03-5544 - 03-5545
DOYEN
with elastic blades
240 mm



Intestinal Clamps, Soft elastic



03-5546

03-5547

1/2

03-5546 - 03-5547
DOYEN
with elastic blades
235 mm

Atraumata

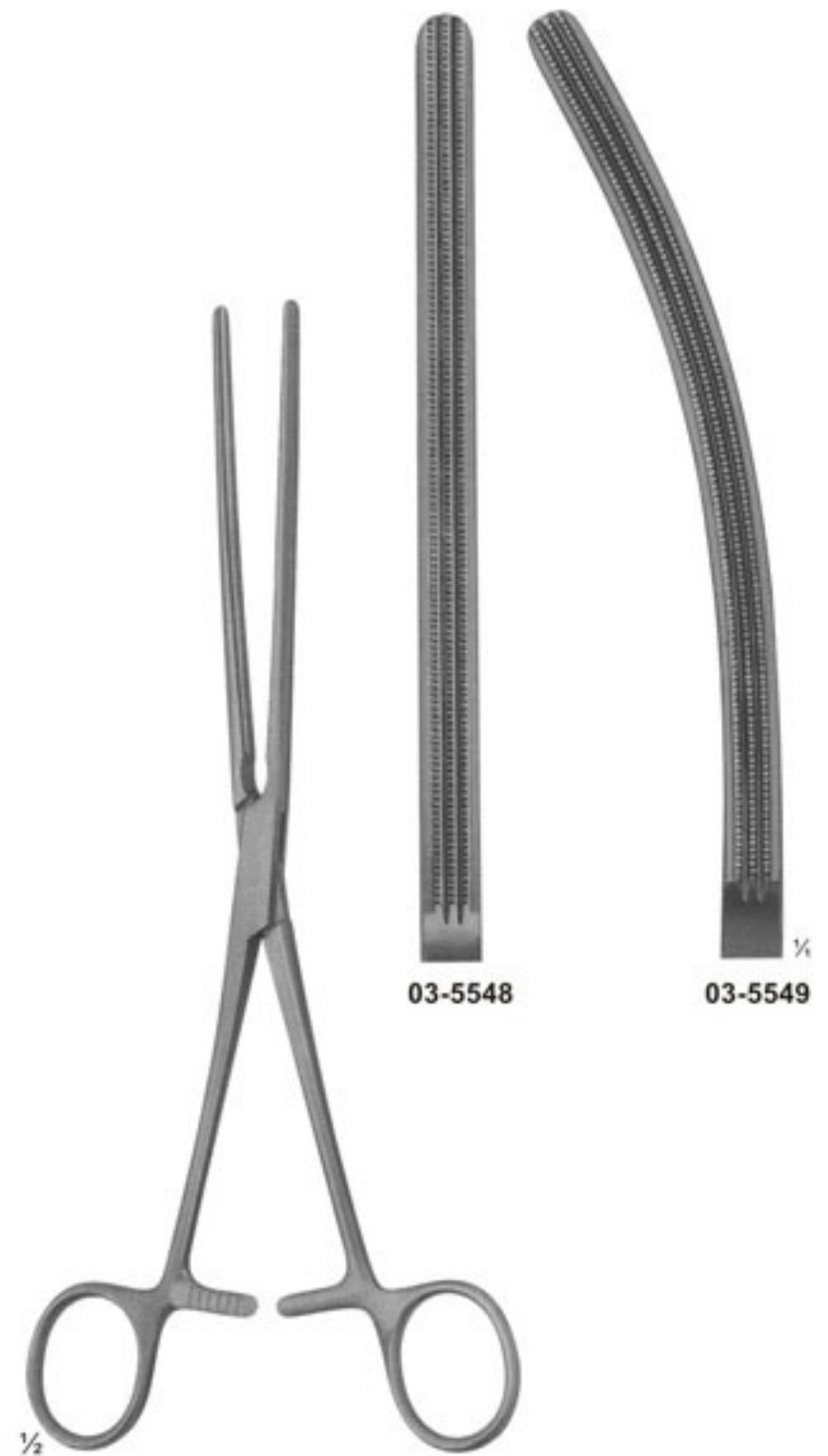

03-5548

03-5549

1/2

03-5548 - 03-5549
DOYEN
with elastic blades
230 mm



Intestinal Clamps, Soft elastic

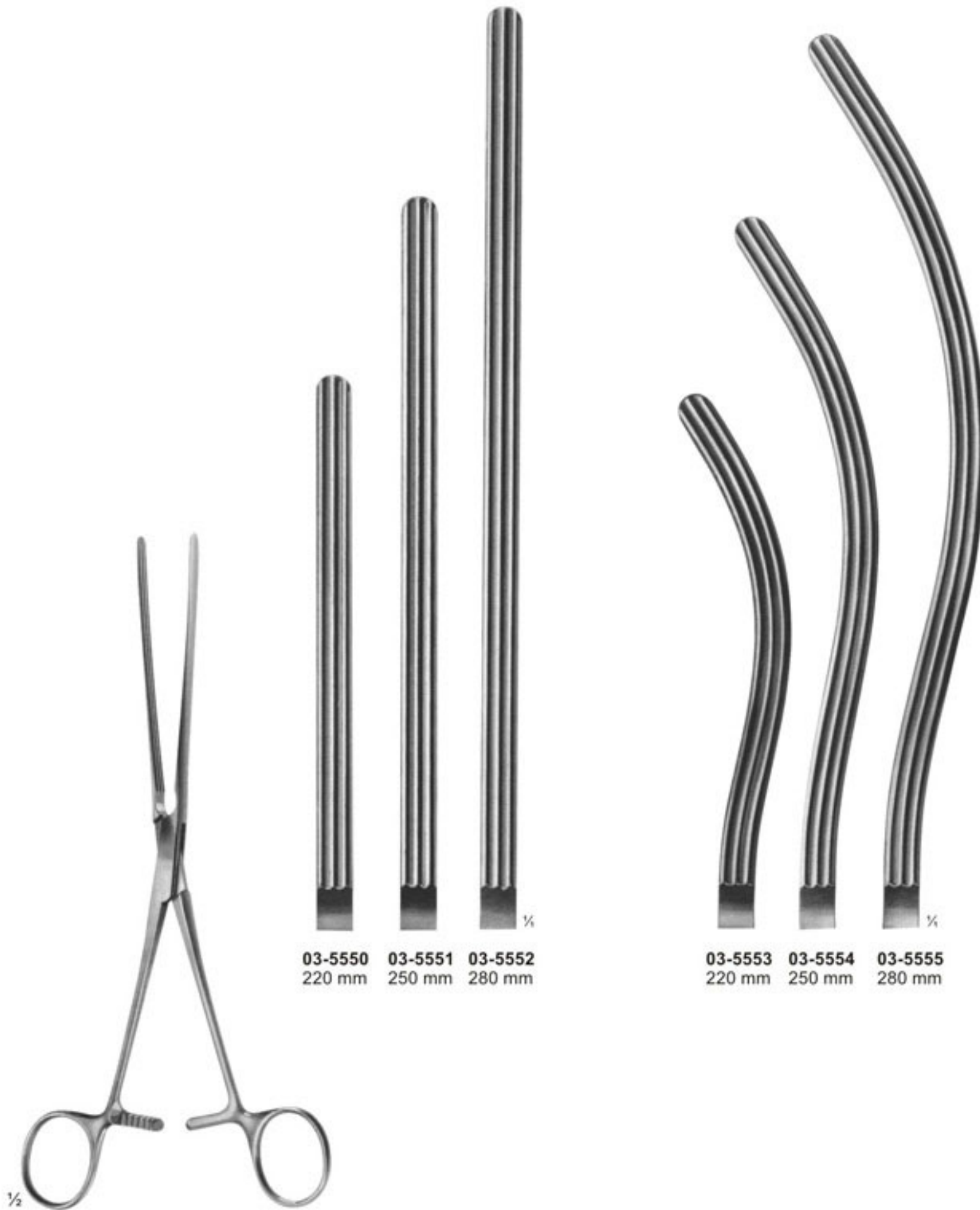

1/2

03-5550 - 03-5555
KOCHER
with very elastic blades

03-5550 220 mm
03-5551 250 mm
03-5552 280 mm

03-5553 220 mm
03-5554 250 mm
03-5555 280 mm



Intestinal Clamps, Soft elastic

Atraumata

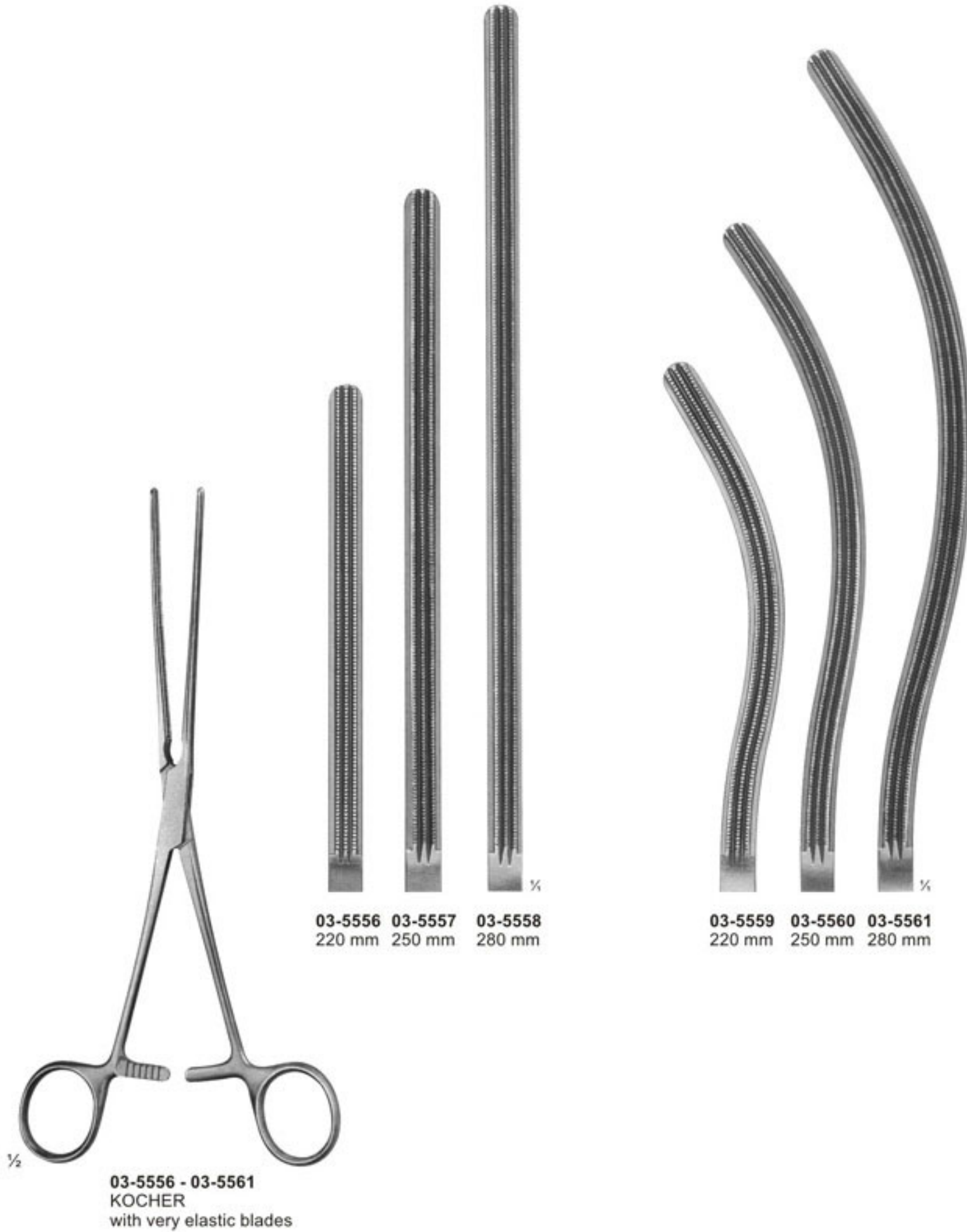



Intestinal Clamps



03-5562 - 03-5563
NUSSBAUM
with elastic blades
250 mm

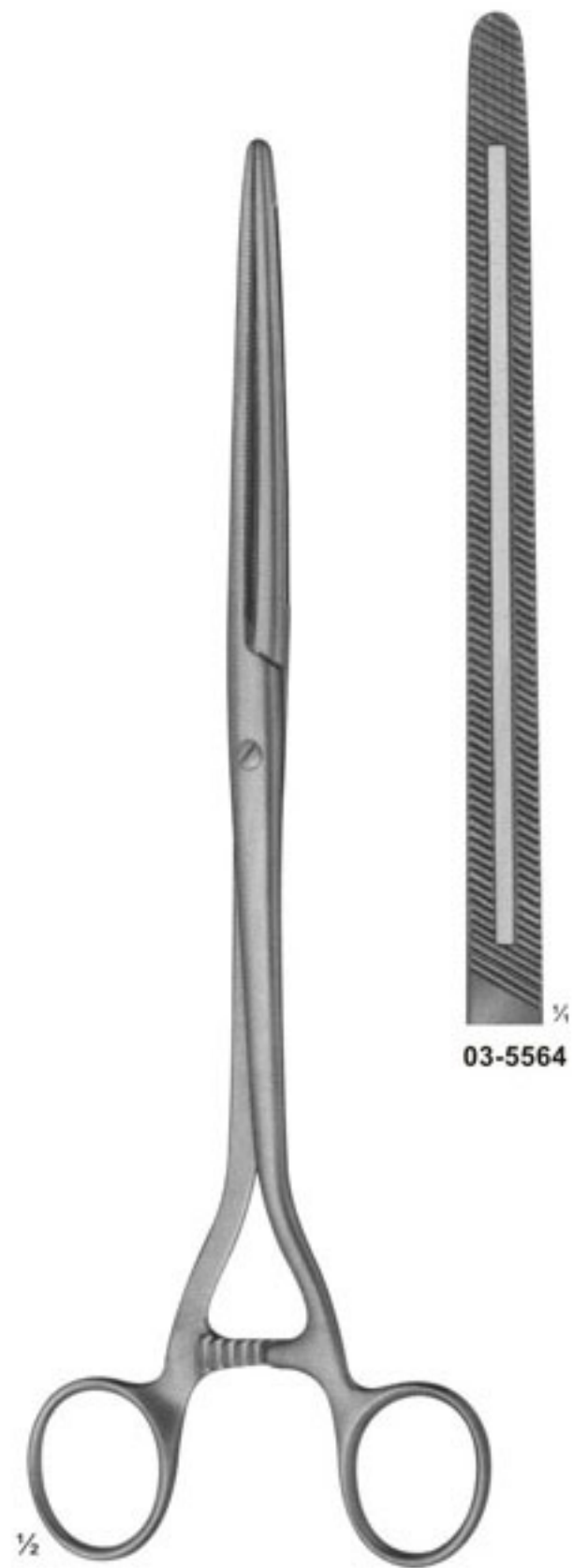

03-5564
MOYNIHAN
280 mm



Intestinal Clamps

Atraumata

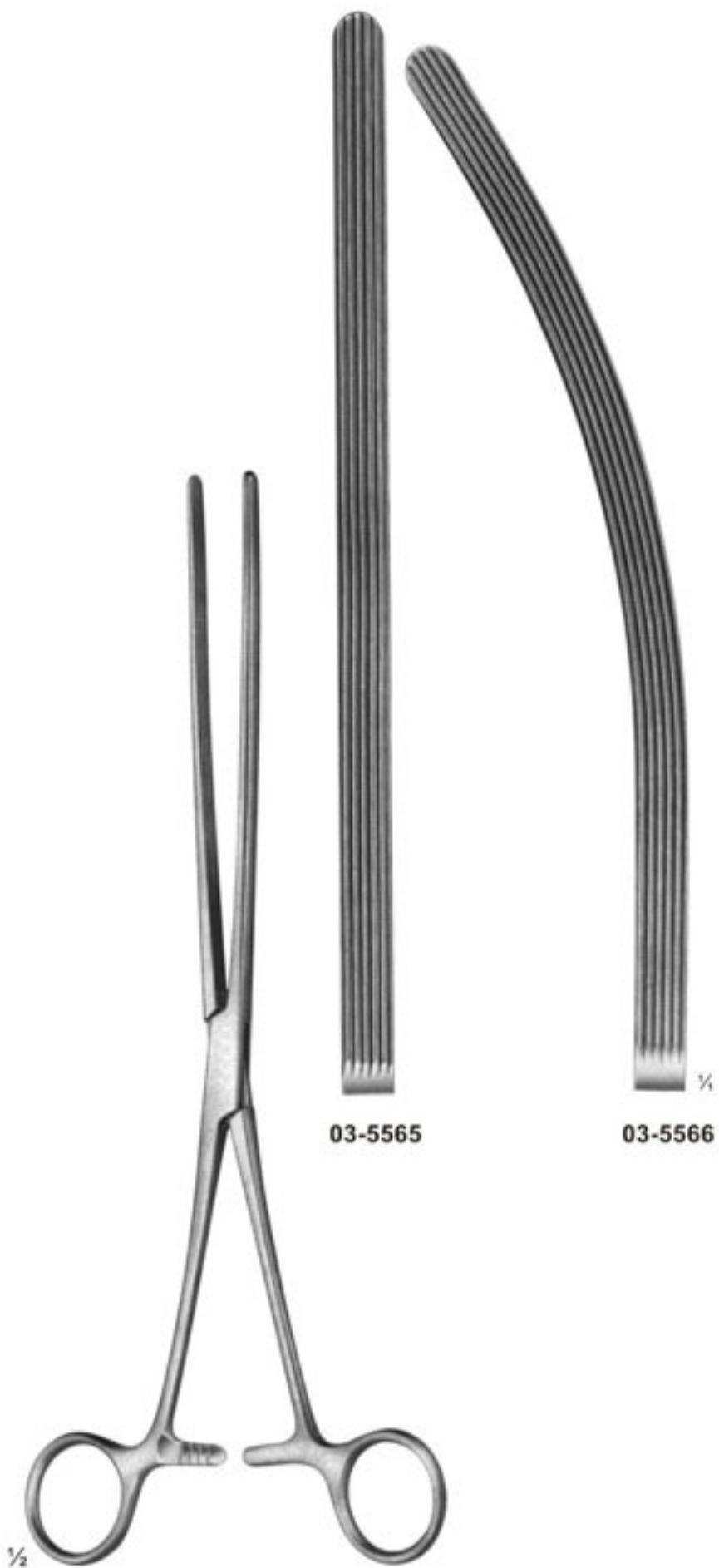

03-5565

03-5566

1/2

03-5565 - 03-5566
MAYO-ROBSON
hard elastic
250 mm

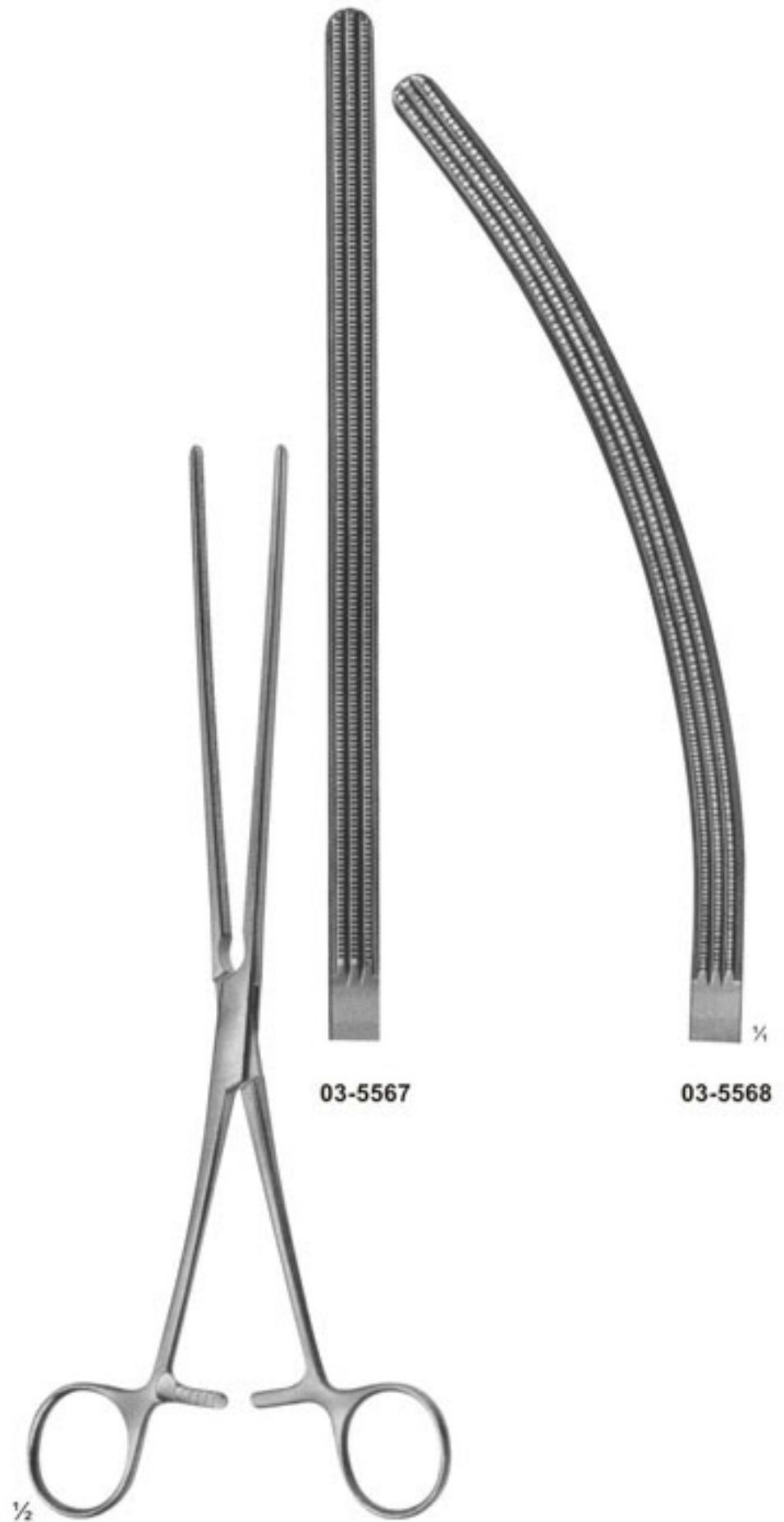

03-5567

03-5568

1/2

03-5567 - 03-5568
MAYO-ROBSON
250 mm



Gastro-Intestinal Forceps, twin



03-5569
LANE
300 mm

03-5570
LANE
300 mm



Stomach Clamps

Atraumata

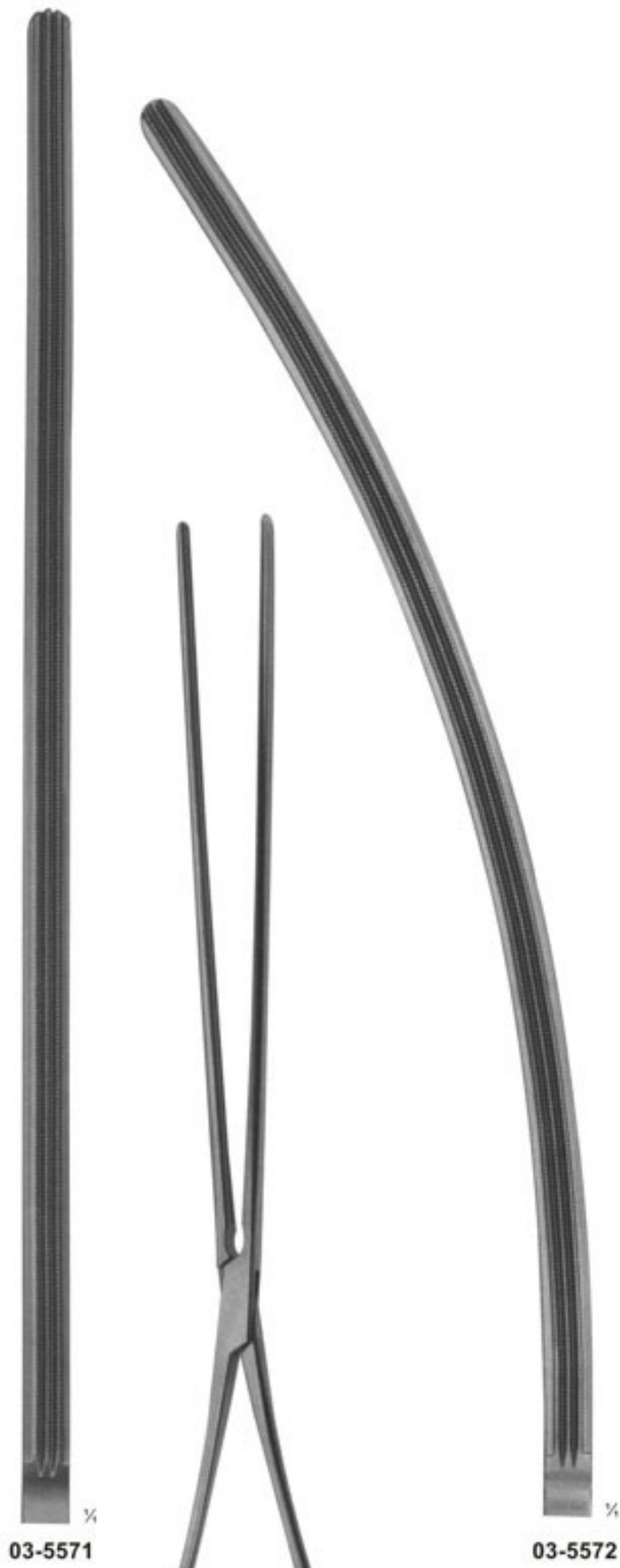

03-5571

03-5572

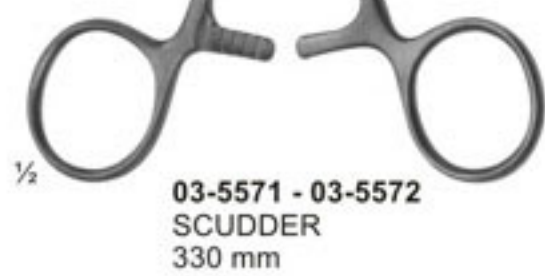

03-5571 - 03-5572
SCUDDER
330 mm



03-5573
KLEINSCHMIDT
Spur crushers and
Appendectomy clamps
130 mm



Intestinal and Pylorus Clamps



1/2
03-5574
PAYR
Intestinal clamp
light pattern,
for children
180 mm

1/2
03-5575
PAYR
200 mm

1/2
03-5576
PAYR
275 mm

1/2
03-5577
PAYR
Pylorus clamp
315 mm



Anastomosis Forceps

Atraumata



03-5578
PARKER-KERR
anastomosis forceps
for colon resection
250 mm

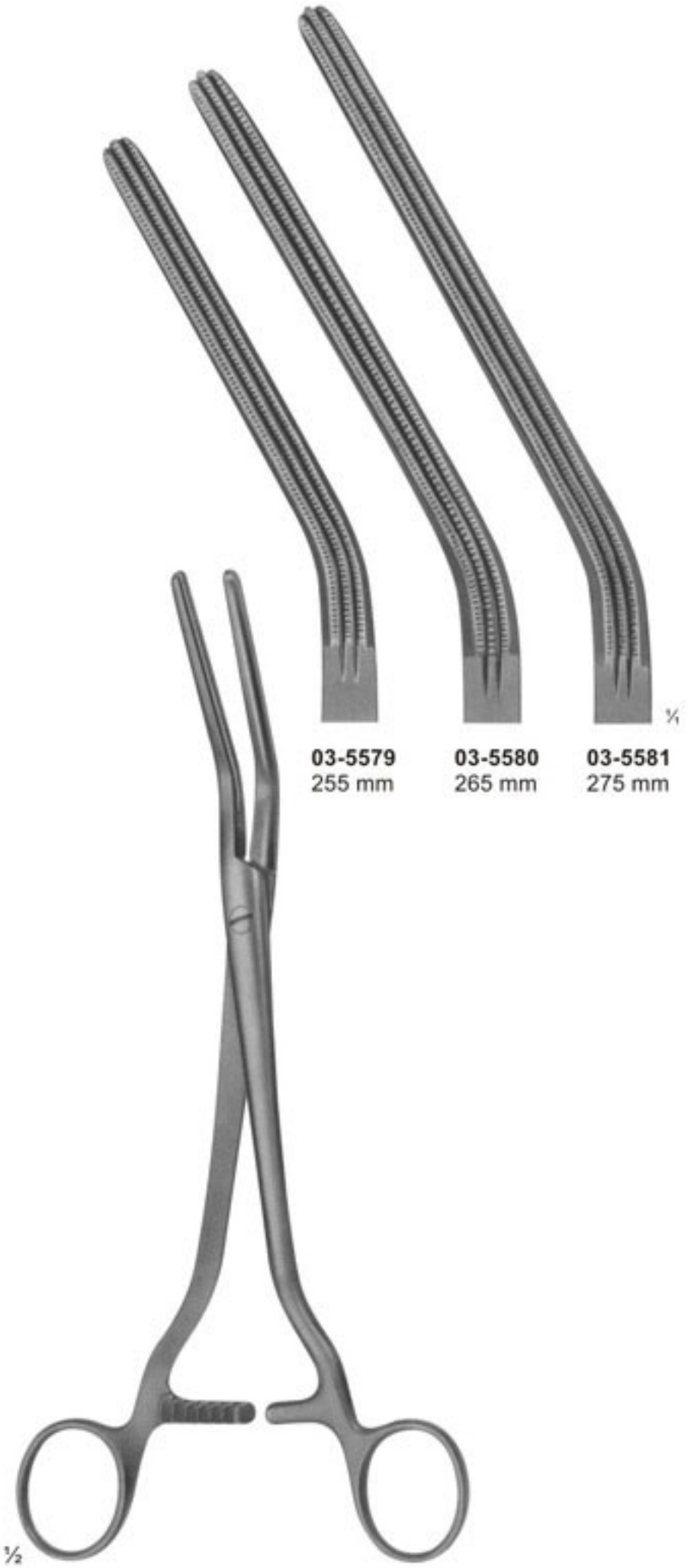

03-5579 - 03-5581
DICK
pressure clamps



Sigmoid Anastomosis Forceps



03-5582
60mm

03-5583
80mm

03-5582 - 03-5583
230 mm

03-5584
LLOYD-DAVIS
315 mm



Atraumata Sigmoid Anastomosis Forceps

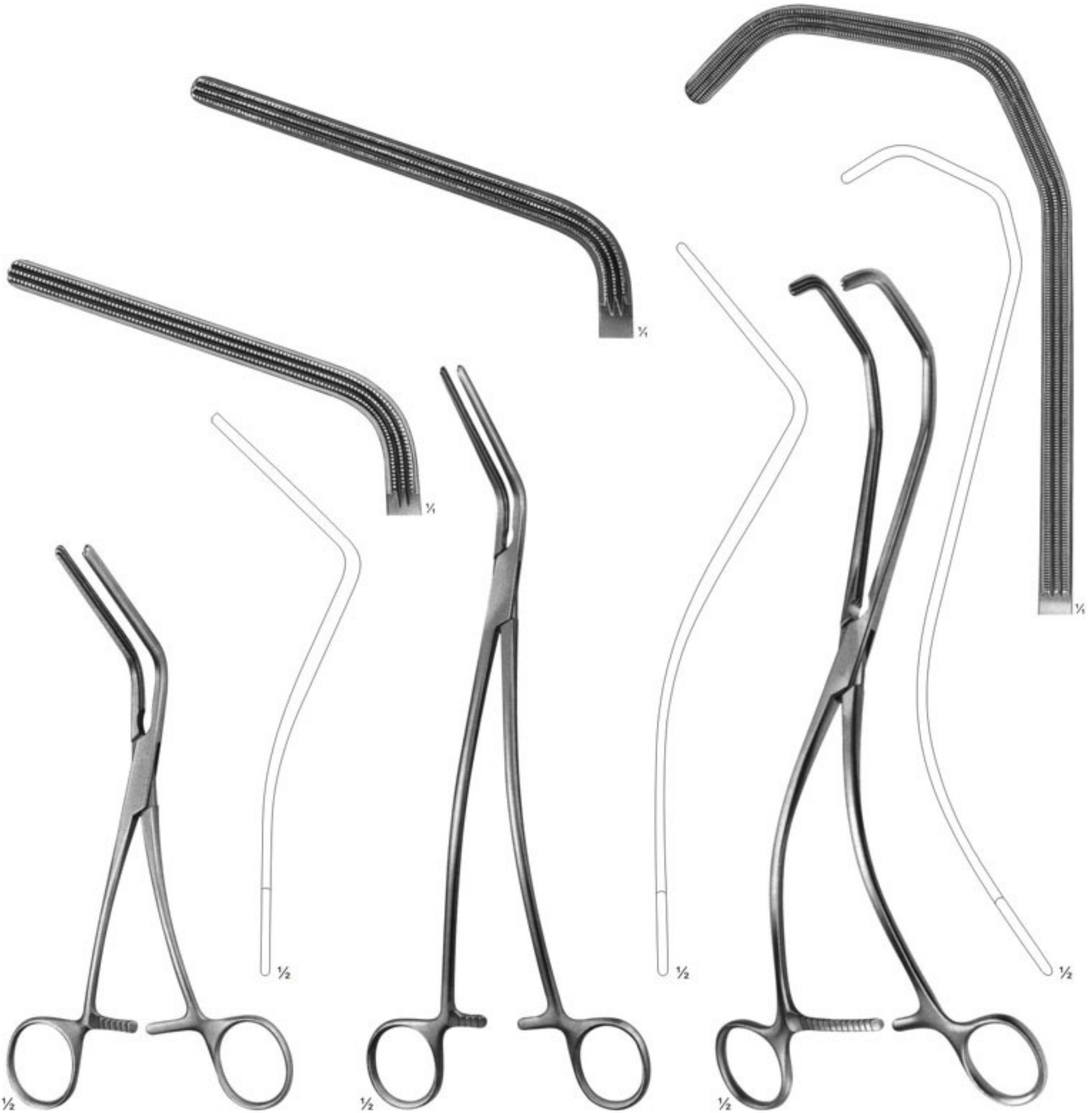

03-5585
MORRIS
175 mm

03-5586
DE BAKEY
(MORRIS modif.)
240 mm

03-5587
KERSTING
270 mm



Rectal Specula

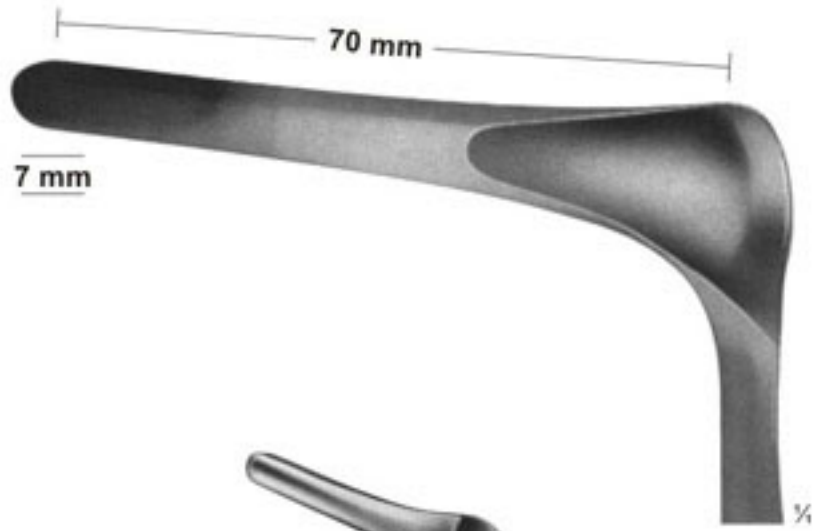

03-5588
KILLIAN
for children
145 mm



03-5589
SIMS
160 mm



03-5590
SIMS
160 mm



Rectal Specula



1/2

03-5591 - 03-5594

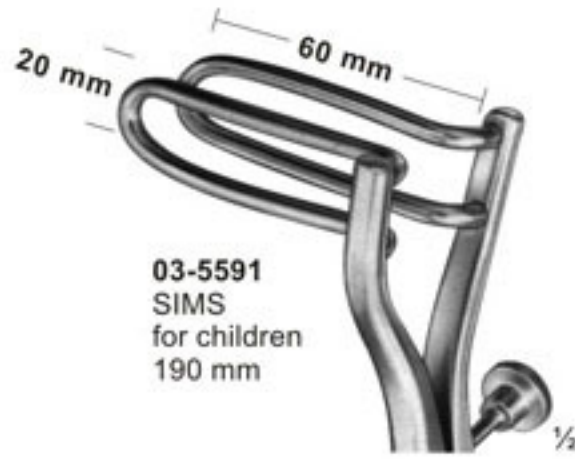

03-5591
SIMS
for children
190 mm

1/2

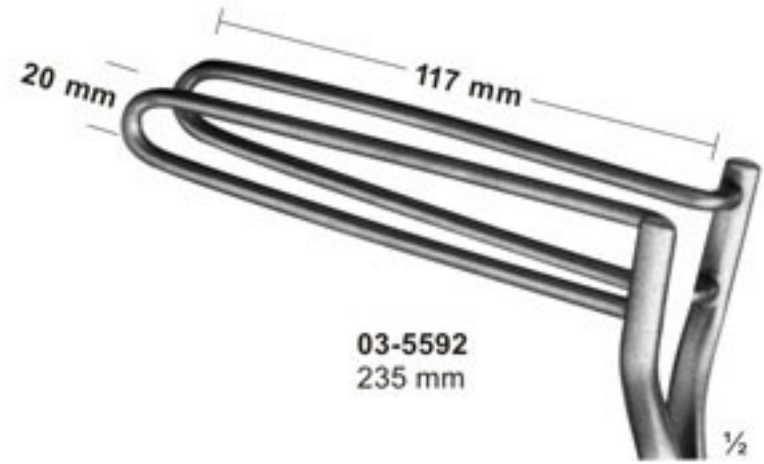

03-5592
235 mm

1/2



03-5593
SIMS
for adults
235 mm

1/2

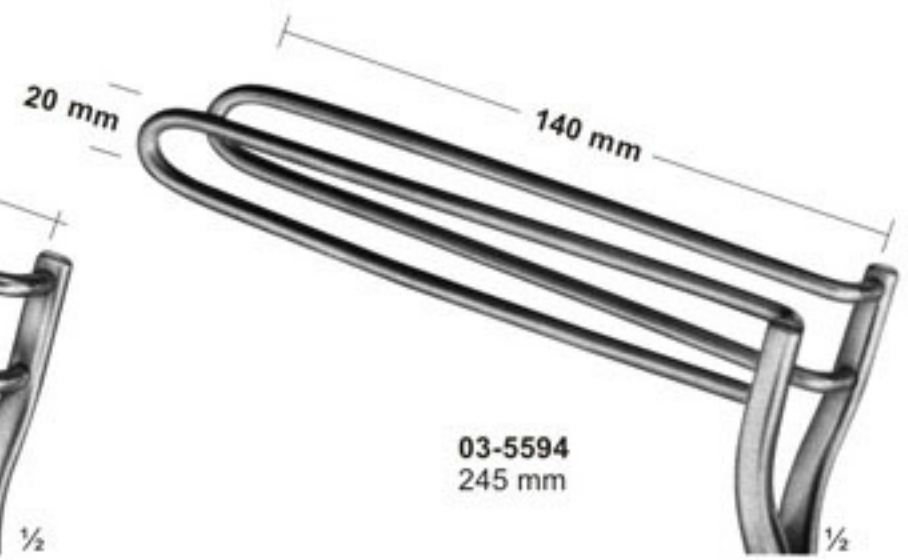

03-5594
245 mm

1/2



1/2

03-5595
PRATT
205 mm

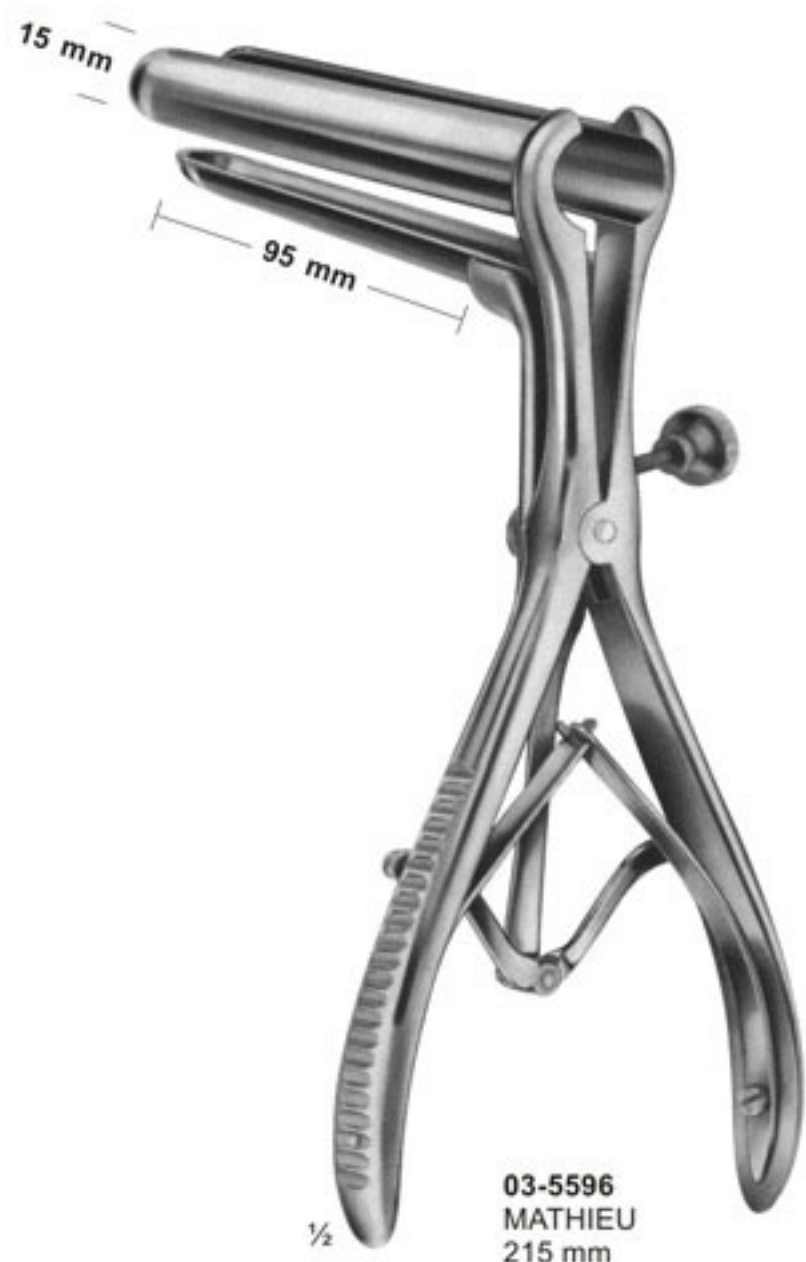

1/2

03-5596
MATHIEU
215 mm



Anuscopes-Sphincteroscopes, Proctoscopes



1/2
03-5597
IVES-FANSLER
Anuscope
145 mm
∅ 24mm



1/2
03-5598
KELLY
Sphincteroscope
160 mm
∅ 21mm

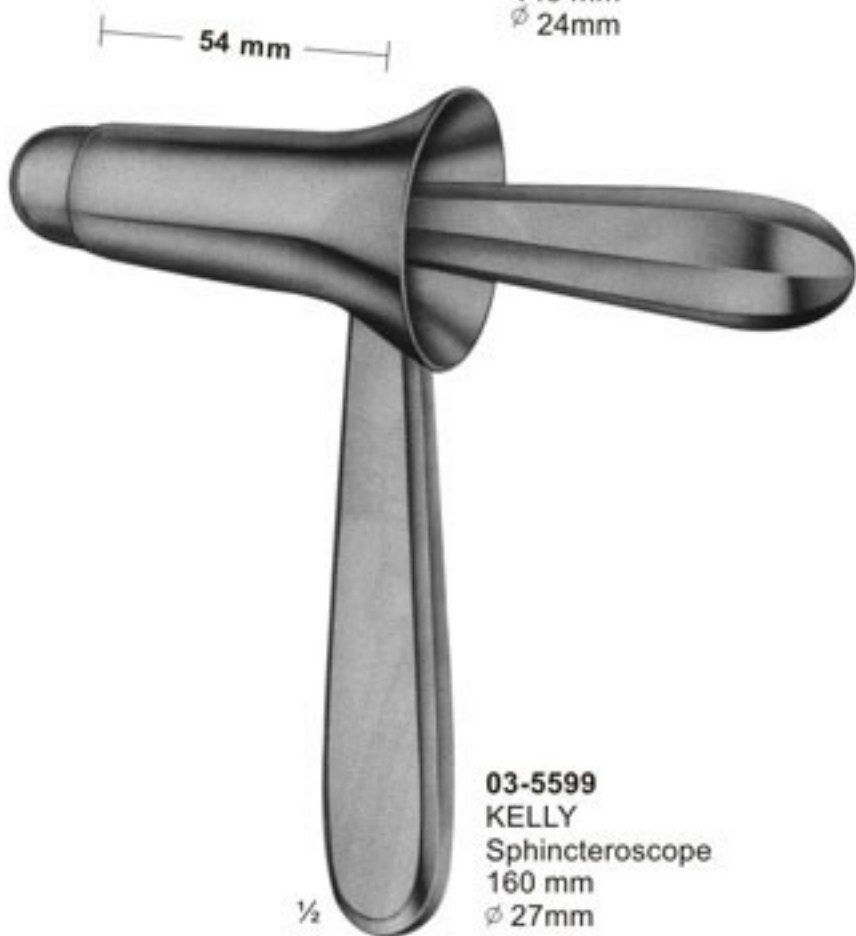

1/2
03-5599
KELLY
Sphincteroscope
160 mm
∅ 27mm

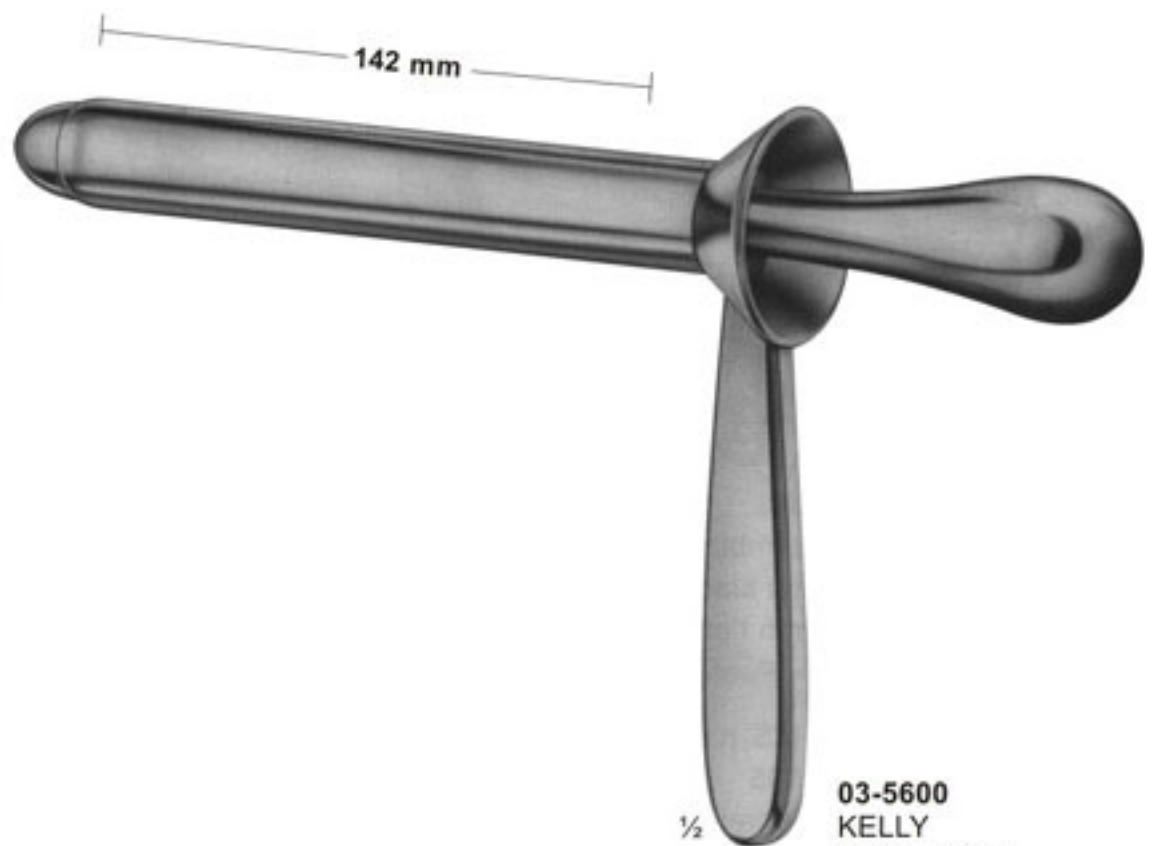

1/2
03-5600
KELLY
Proctoscope
140 mm
∅ 22mm



Biopsy forceps for rectum

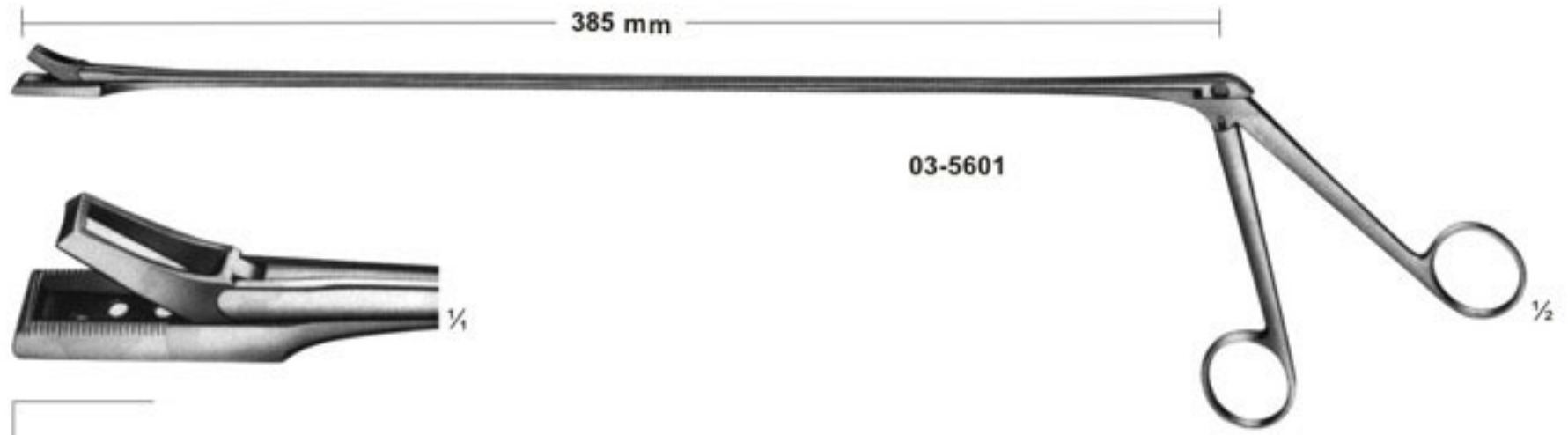

03-5601

5,8 mm

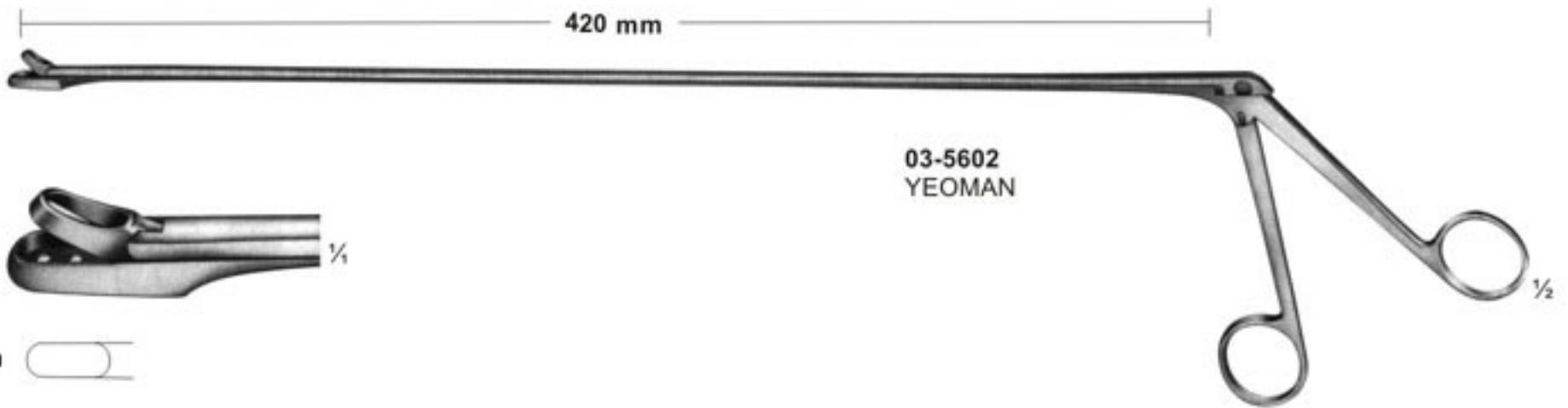

03-5602
YEOMAN

4,0 mm

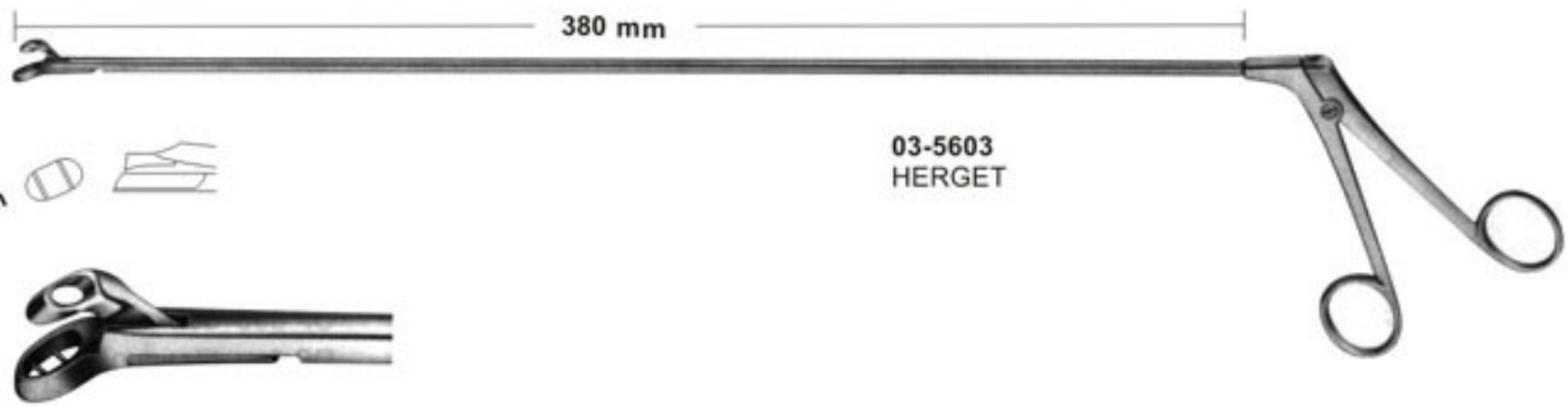

03-5603
HERGET

3,5 mm

With Drawing Cut

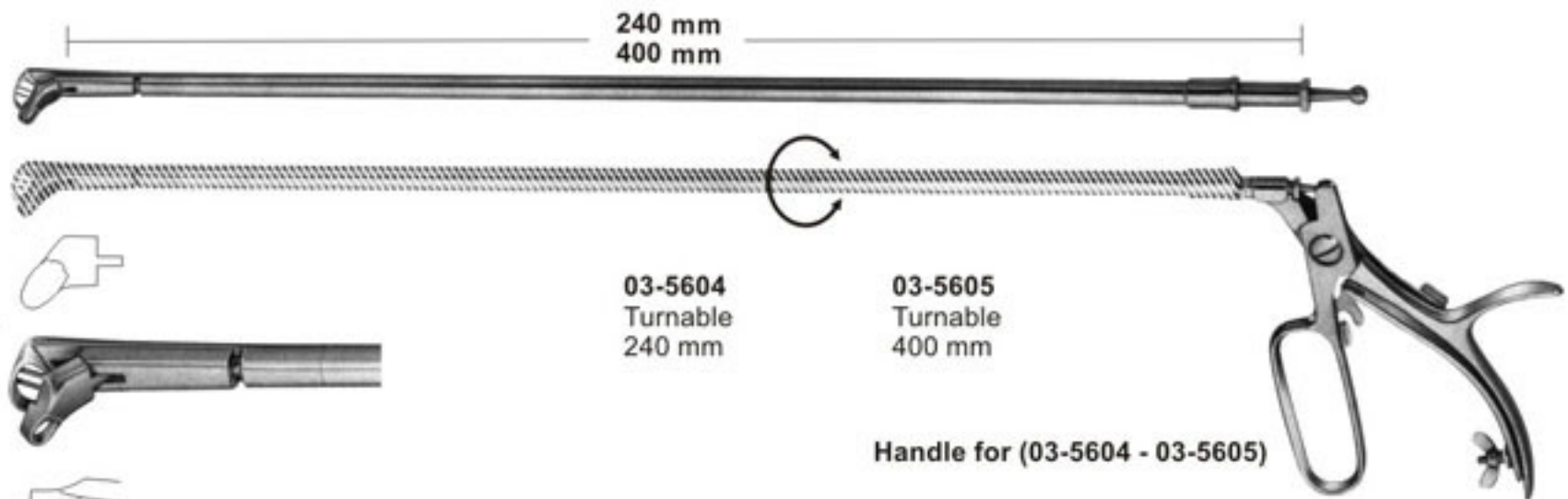

03-5604
Turnable
240 mm

03-5605
Turnable
400 mm

3,8 mm

Handle for (03-5604 - 03-5605)

With Drawing Cut,
Attachments only



Biopsy Forceps & Swab Holders

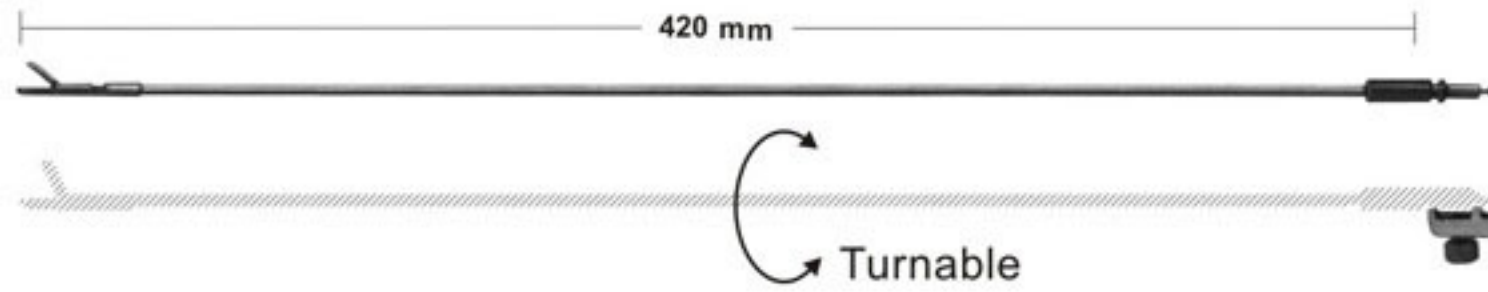

3,5 mm   ¼ 03-5606

3,5 mm   ¼ 03-5607

4,0 mm   ¼ 03-5608

4,0 mm   ¼ 03-5609

Biopsy Forceps

03-5606 - 03-5609
Handle for



3,5 mm   ¼

03-5610 - 03-5611
Biopsy Forceps, spoon-shaped
oval jaws, straight.
03-5610 350mm
03-5611 500mm

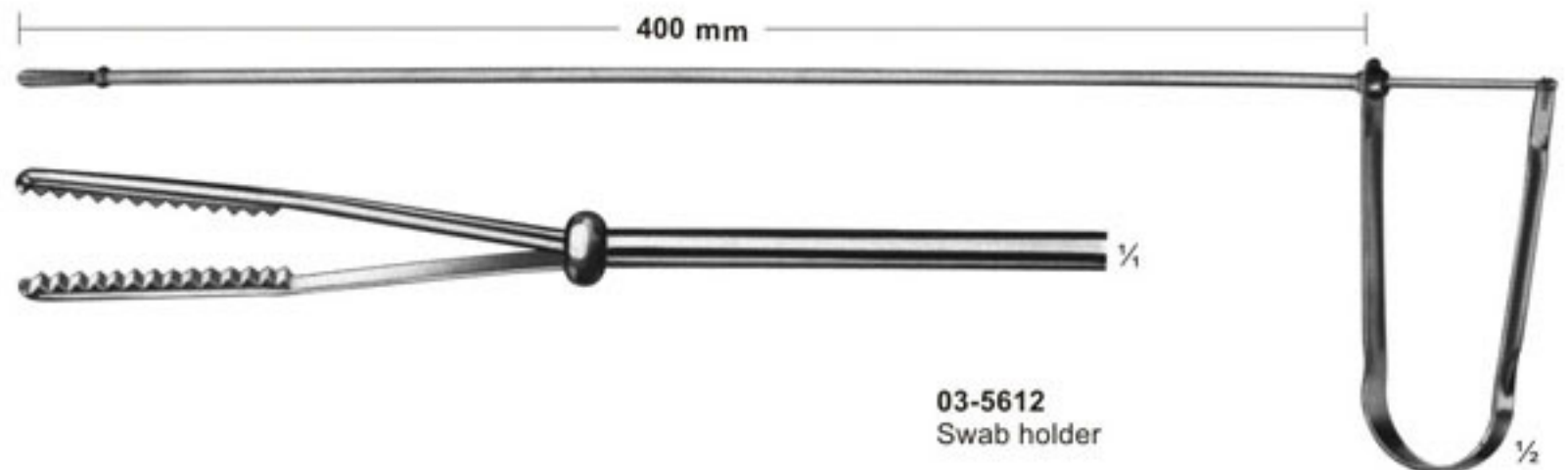



Haemorrhoidal Forceps

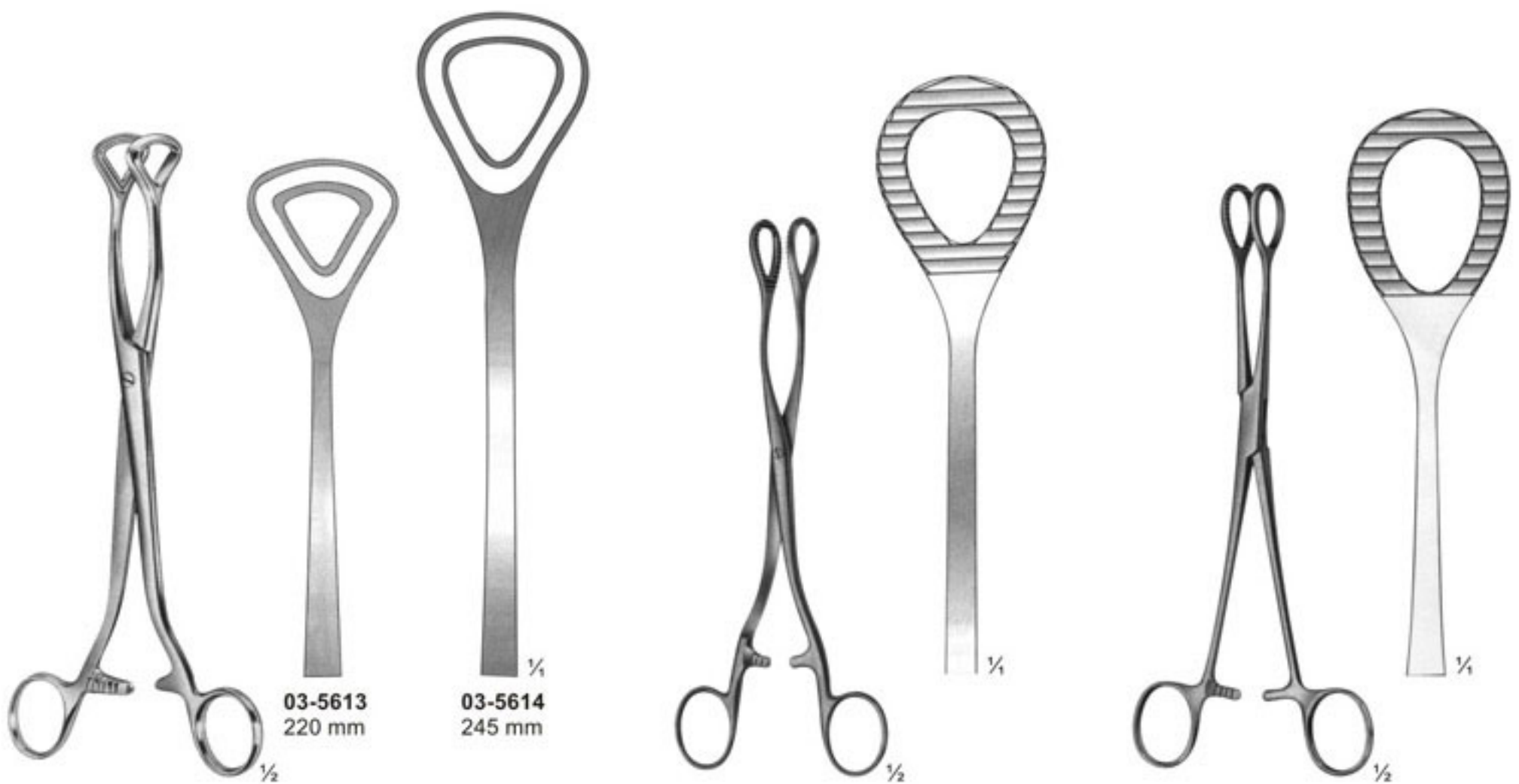

03-5613 - 03-5614
LUER

03-5613
220 mm

03-5614
245 mm

03-5615
HEYWOOD-SMITH
200 mm

03-5616
HEYWOOD-SMITH
modif
215 mm



Haemorrhoidal Forceps

Atraumata



03-5617

03-5618

Pressure Clamp

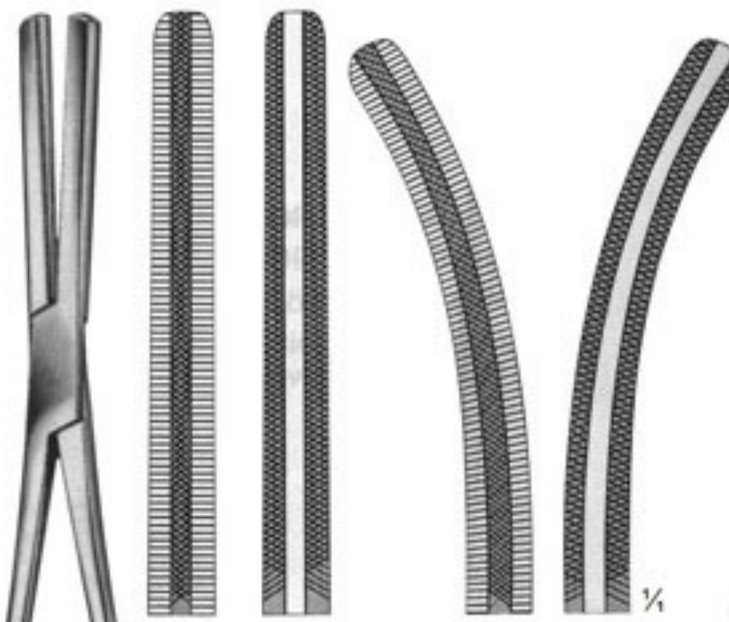

03-5619

03-5620



03-5621
RUDD
Haemorrhoidal ligator
with loading
attachment and 100
ligature rubber rings
315 mm



03-5617
250 mm
03-5618
270 mm



03-5619 - 03-5620
FERGUSSON
200 mm