

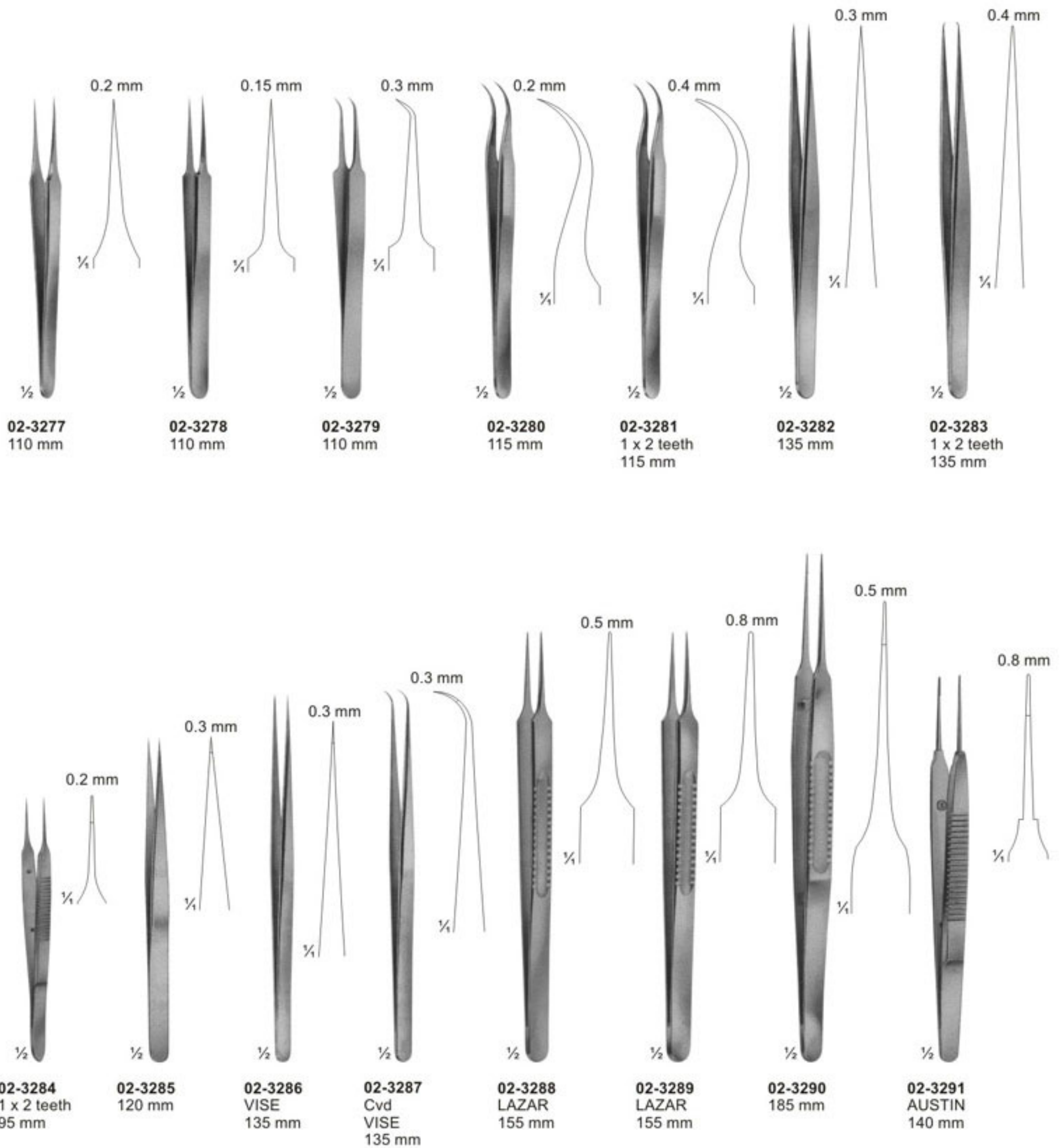

Micro Forceps, Jeweler Types and Micro Suture Tying Forceps





Micro Forceps, Ligature Forceps (Light Patterns) Bayonet - Shaped

0.15 mm 0.20 mm 0.30 mm 0.50 mm

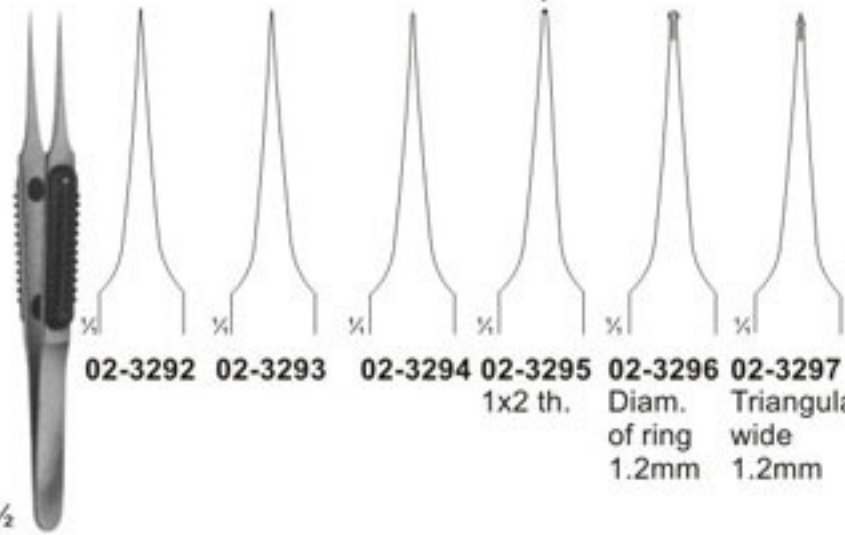

02-3292 02-3293 02-3294 02-3295
1x2 th. 02-3296 02-3297
Diam. of ring 1.2mm Triangular wide 1.2mm

02-3292 - 02-3297
MULLER
110 mm



02-3298
LIGATURE
FORCEPS
220 mm



02-3299
YASARGIL
Ligature forceps
185 mm

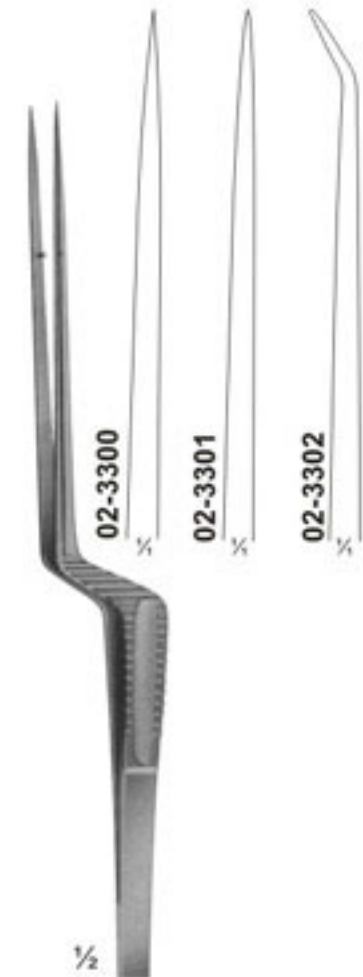

02-3300 - 02-3302
MICRO FORCEPS
Ligature pattern
185 mm



0.6 mm 0.9 mm
02-3303 02-3304 02-3305
1x2 teeth

02-3303 - 03-3305
YASARGIL
180 mm



0.6 mm 0.9 mm
02-3306 02-3307

02-3306 - 02-3307
YASARGIL
200 mm



0.6 mm
02-3308

02-3308 - 03-3309
YASARGIL
220 mm



0.9 mm
02-3309



0.6 mm
02-3310

02-3310 - 02-3311
YASARGIL
240 mm



0.9 mm
02-3311



Forceps for Grasping Tissue, Tumors, Bayonet Shaped



02-3312 - 02-3314
YASARGIL-SAMII
Jaws Spoon-Shaped
240 mm



02-3315 - 02-3316
YASARGIL
Jaws Spoon-Shaped
220 mm



02-3317 - 02-3319
SAMII
Jaws Spoon-Shaped
230 mm



02-3320 - 02-3322
SAMII
Jaws Spoon-Shaped
230 mm

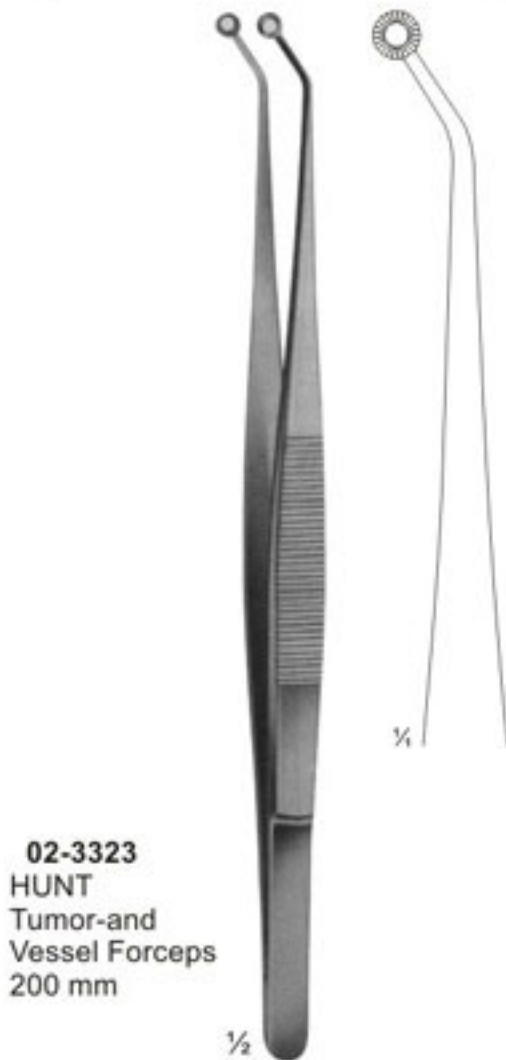

02-3323
HUNT
Tumor-and
Vessel Forceps
200 mm



02-3324
HUNT
Tumor-and
Vessel Forceps
200 mm

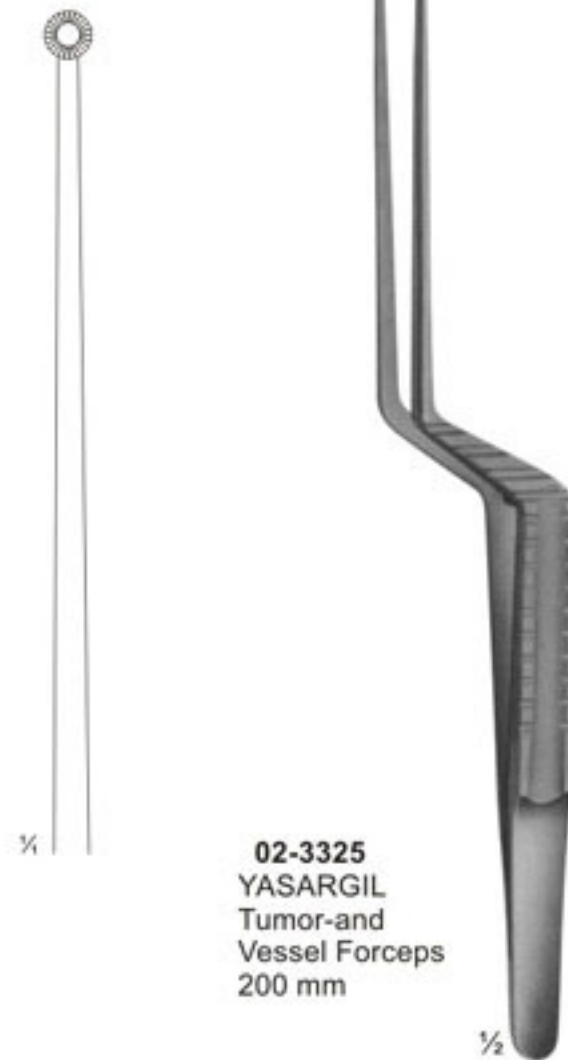

02-3325
YASARGIL
Tumor-and
Vessel Forceps
200 mm



Delicate Dissecting, Microscopic, Sterilizing Forceps



02-3326
THORPE
Corneal forceps
120 mm

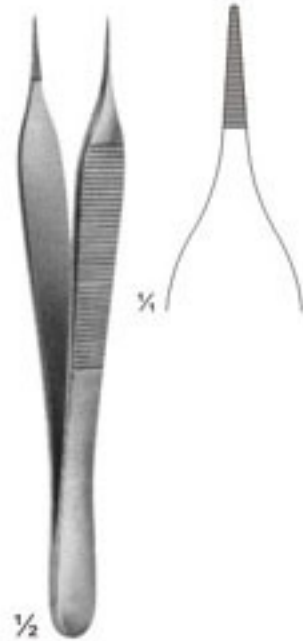

02-3327
MICRO-ADSON
120 mm

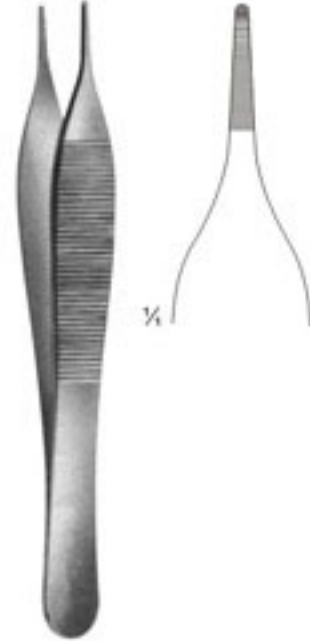

02-3328
ADSON
120 mm



02-3329
MICRO-ADSON
150 mm



02-3330 - 02-3332
100 mm



02-3330



02-3331



02-3332

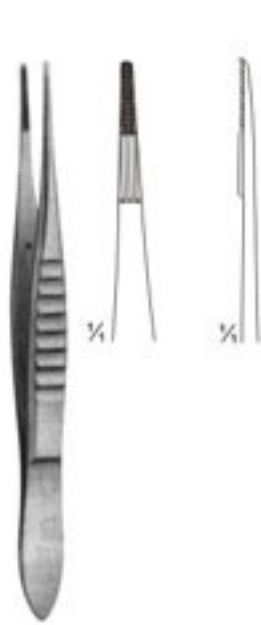

02-3333
BONACCOLTO
110 mm

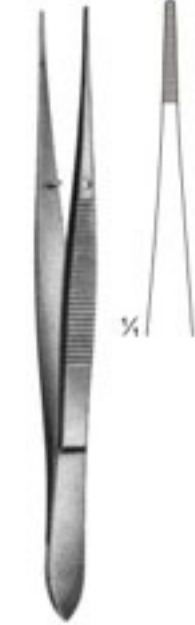

02-3334
115 mm



02-3335 - 02-3344



02-3335
90 mm



02-3336
105 mm



02-3337
115 mm



02-3338
130 mm



02-3339
145 mm



02-3340
90 mm



02-3341
105 mm



02-3342
115 mm



02-3343
130 mm



02-3344
145 mm



02-3345
100 mm



02-3346
100 mm



02-3347
100 mm



02-3348
KUHNE
Cover glass forceps
105 mm



02-3349
160 mm



Delicate Dissecting Forceps

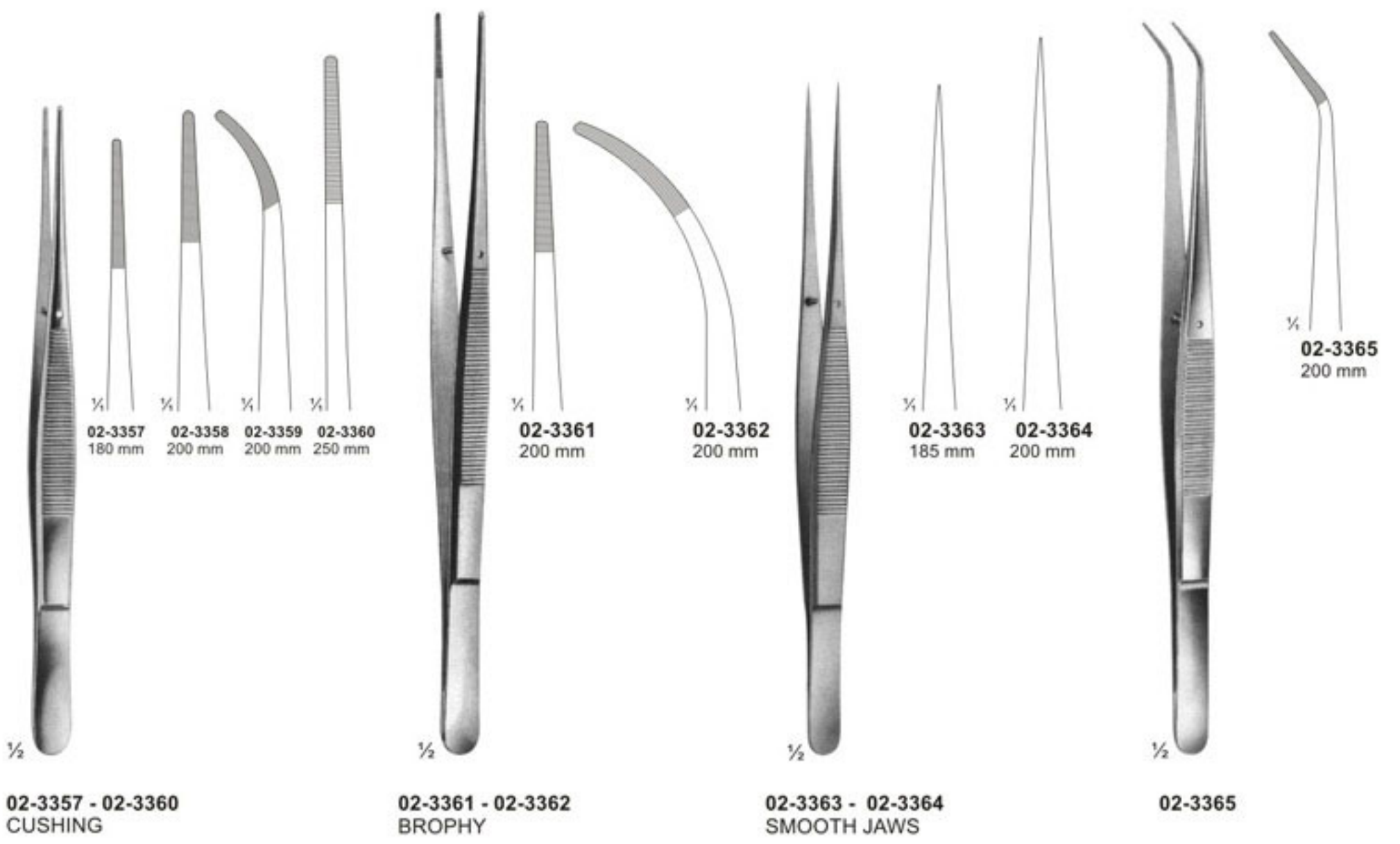
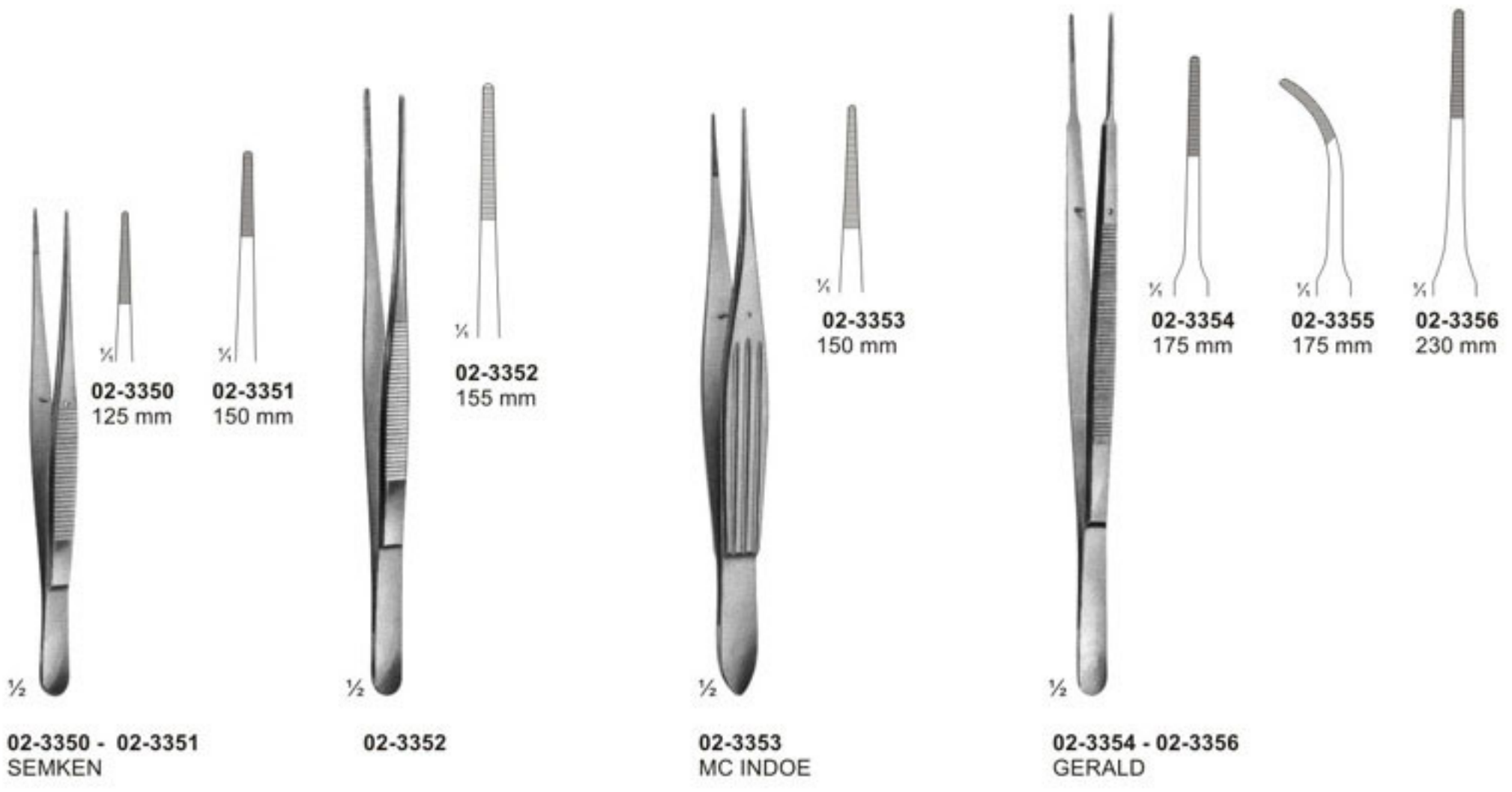



Dissecting Forceps



1/4
02-3366
115 mm

1/4
02-3367
130 mm

1/4
02-3368
145 mm

1/4
02-3369
160 mm

1/4
02-3370
180 mm

1/4
02-3371
200 mm

1/4
02-3372
250 mm

1/4
02-3373
300 mm

02-3366 - 03-3373
STANDARD



1/4
02-3374
115 mm

1/4
02-3375
130 mm

1/4
02-3376
145 mm

1/4
02-3377
160 mm

1/4
02-3378
305 mm



1/4
02-3379
130 mm

1/4
02-3380
145 mm

02-3374 - 02-3378
MEDIUM

02-3379 - 02-3380
MEDIUM



Dissecting Forceps

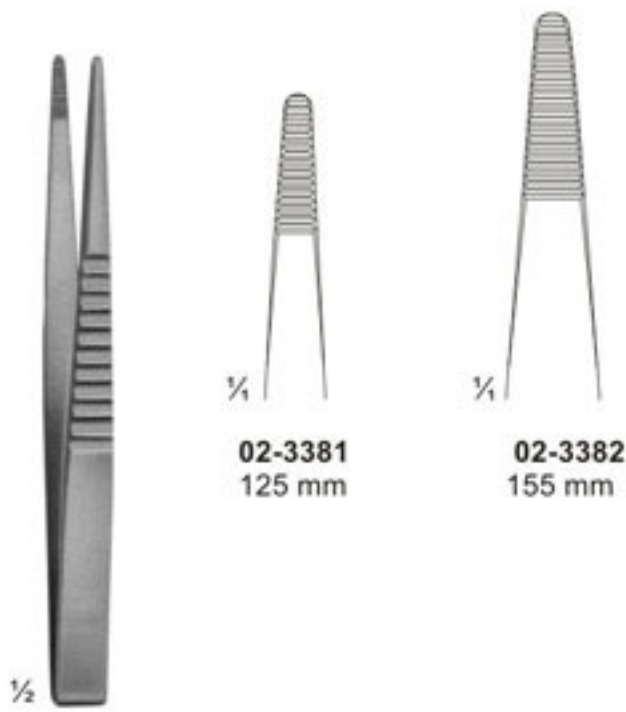

02-3381
125 mm

02-3382
155 mm

02-3381 - 02-3382

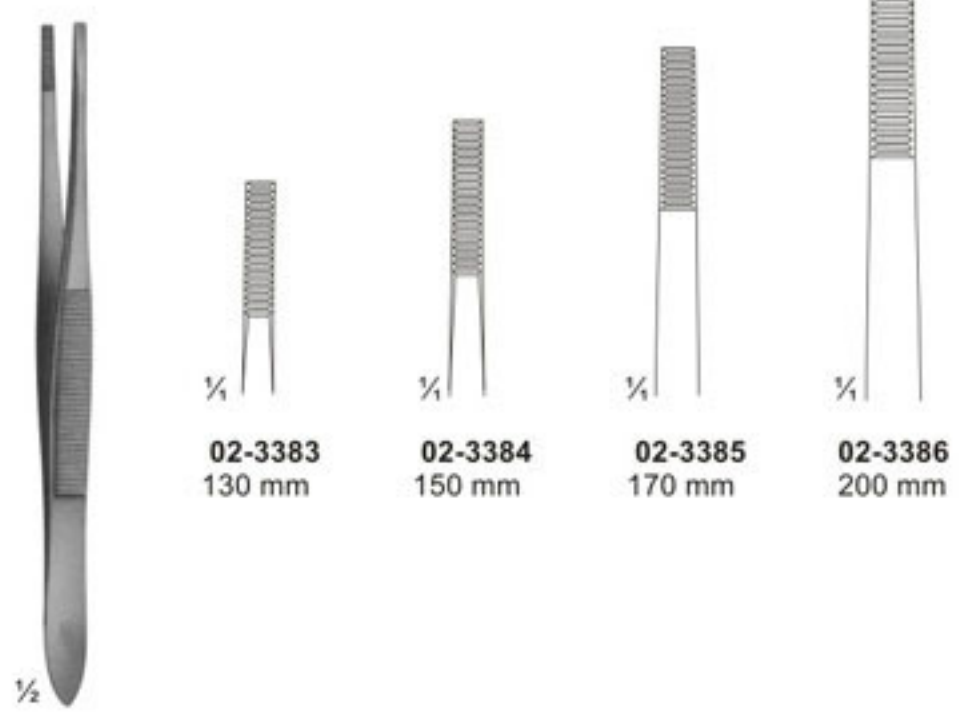

02-3383
130 mm

02-3384
150 mm

02-3385
170 mm

02-3386
200 mm

02-3383 - 02-3386
Swedish pattern

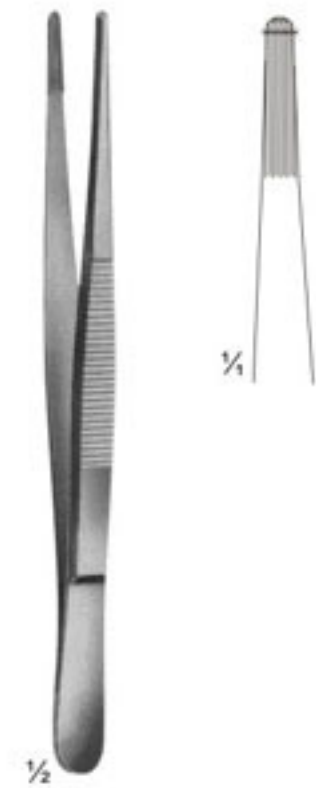

02-3387
OCHSNER
Ligature forceps
145mm

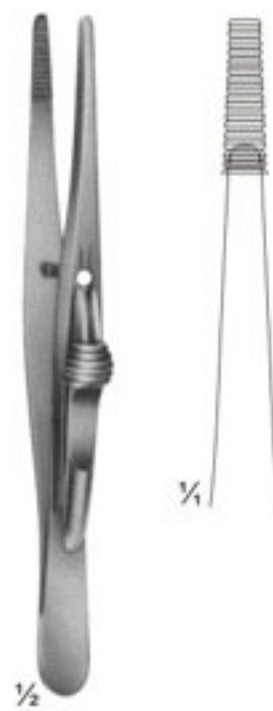

02-3388
FRICKE
Artery forceps
130mm

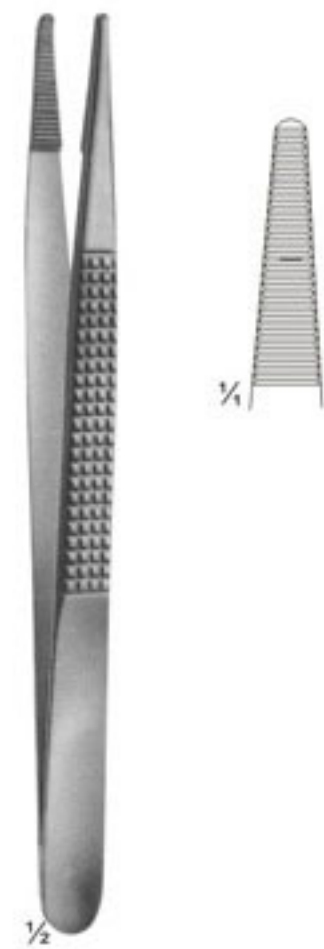

03-3389
BONNEY
175mm



Ultra-Light Forceps ATRAUMATA

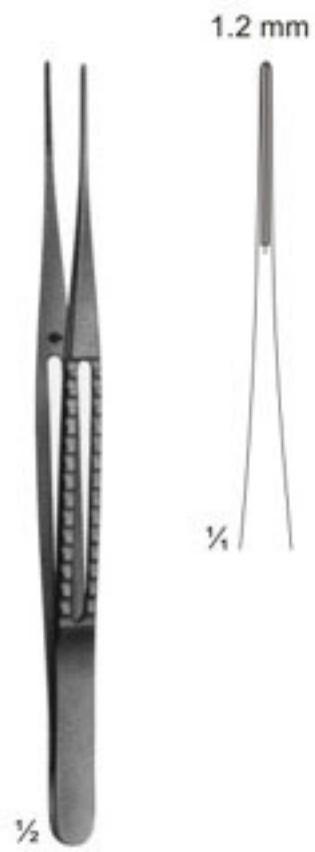

02-3390
150 mm

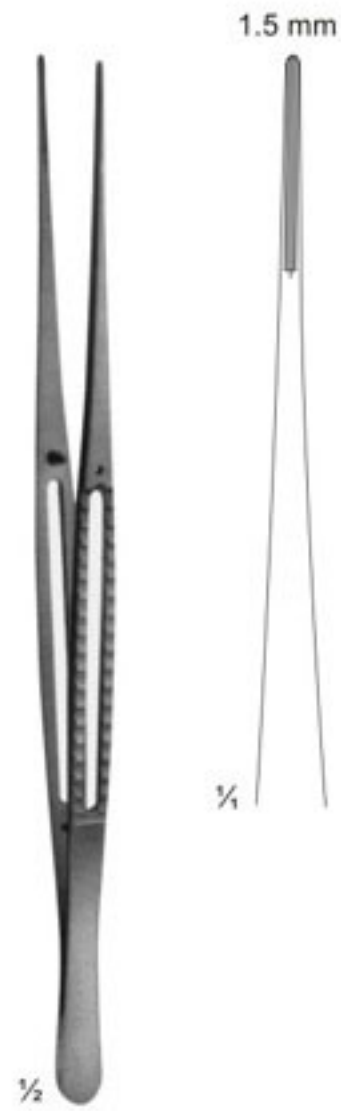

02-3391
200 mm

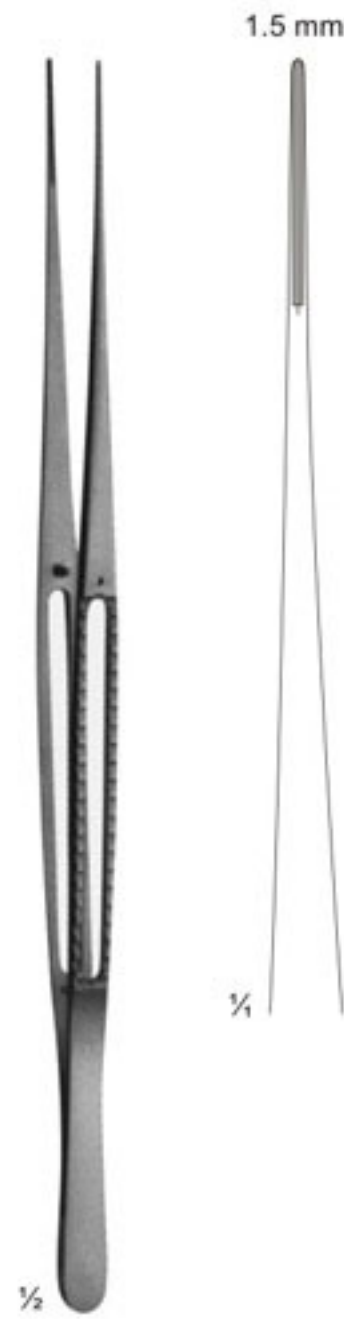

02-3392
240 mm

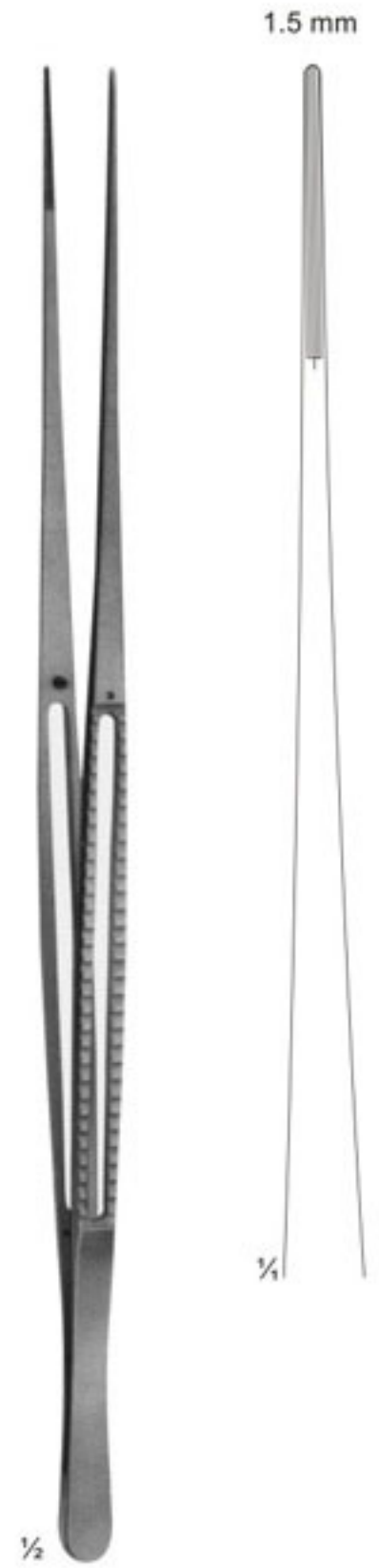

02-3393
300 mm



Forceps ATRAUMATA

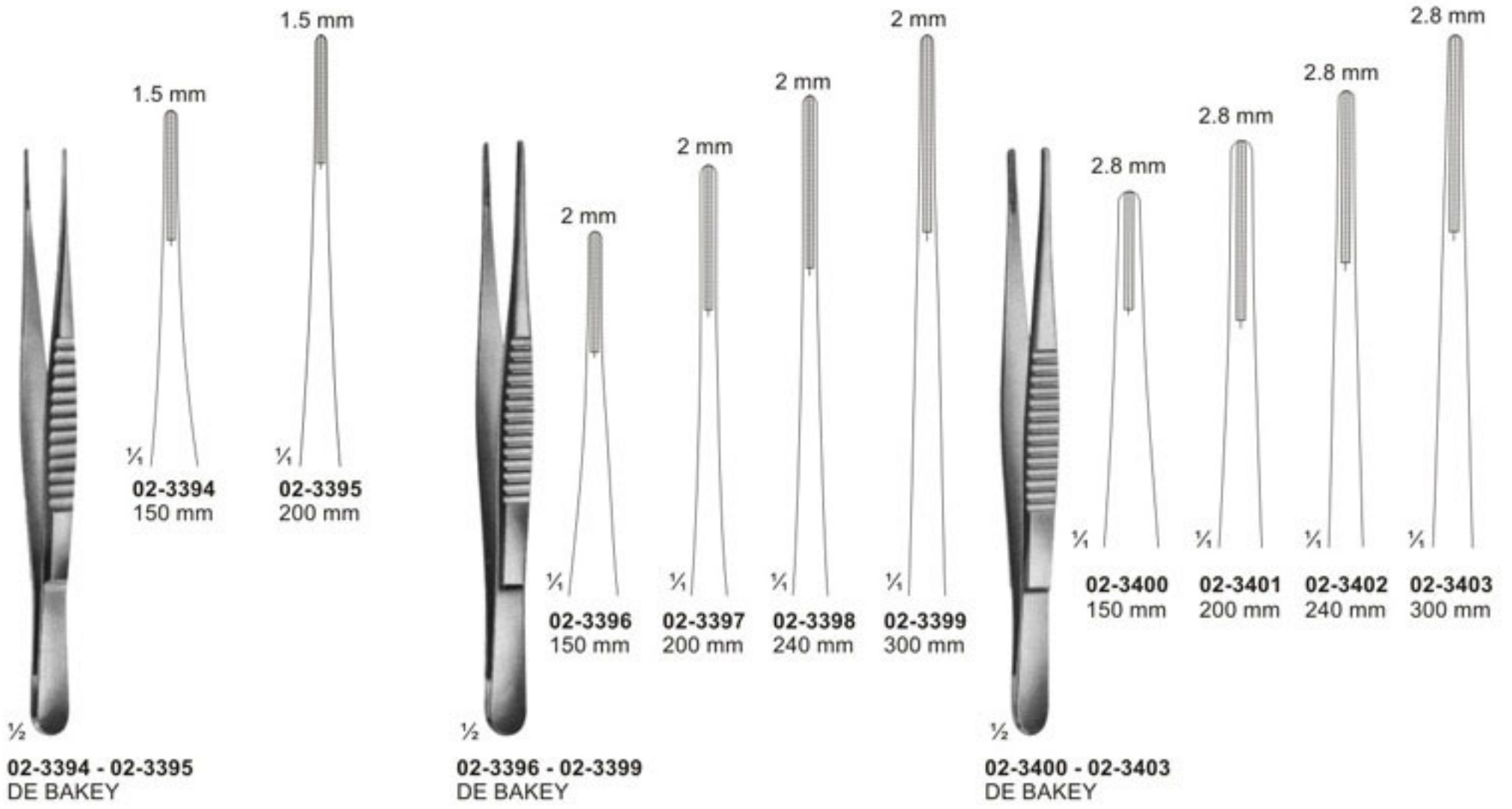



Forceps, Bayonet - Shaped, Angular



02-3409
LUCAE
140 mm

02-3410
LUCAE
1x2 teeth
140 mm

02-3411
COTTLE
Forceps with
jaws toothed
and serrated
140 mm

02-3412
JANSEN
160 mm

02-3413
GRUENWALD
200 mm

02-3414
1x2 teeth
200 mm

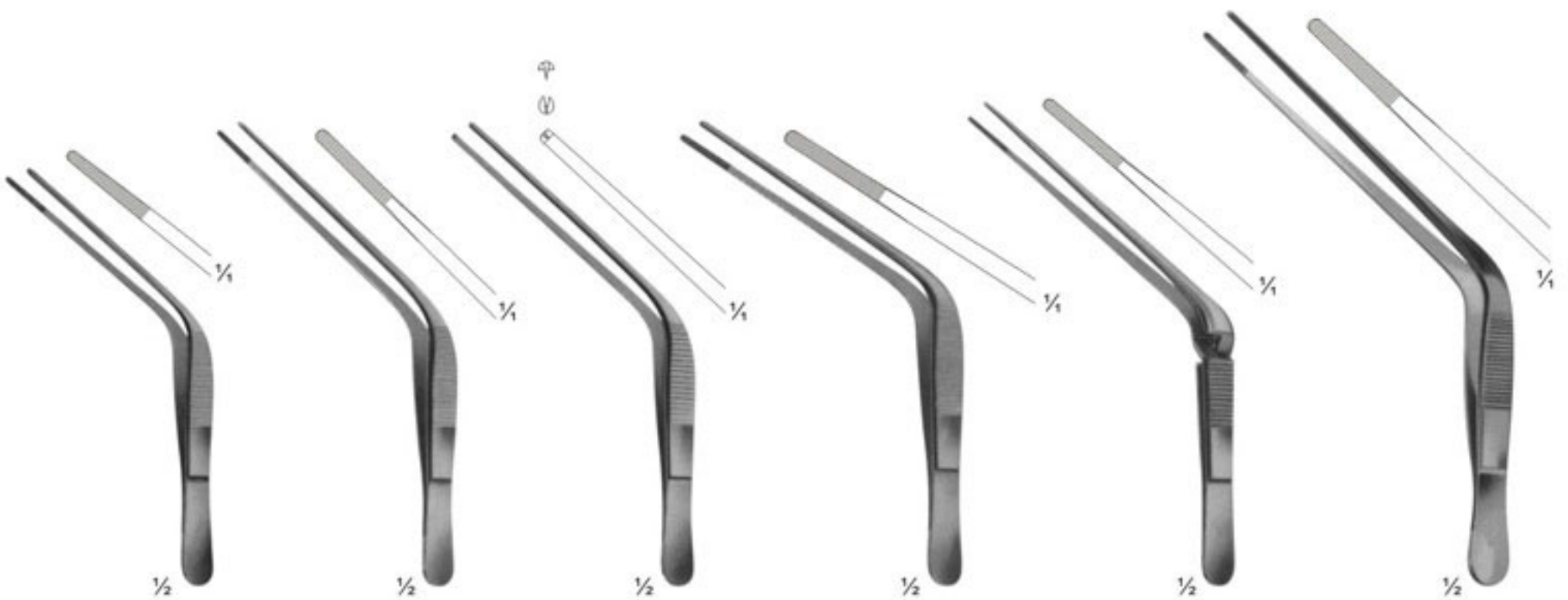

02-3415
TROELTSCH
100 mm

02-3416
TROELTSCH
115 mm

02-3417
TROELTSCH
1X2 teeth
115 mm









02-3418
WILDE
115 mm

02-3419
TROELTSCH
Cross action
120 mm

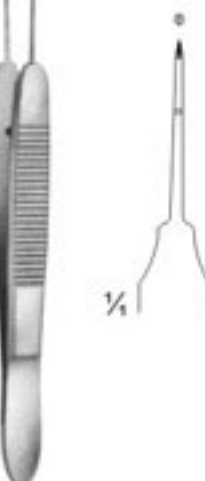
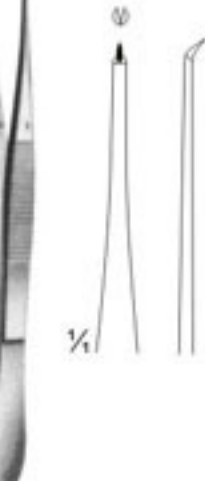
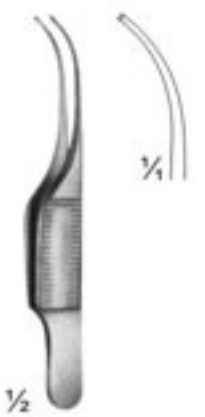
02-3420
TROELTSCH
140 mm

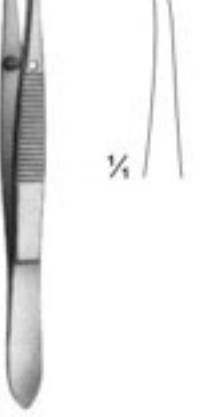

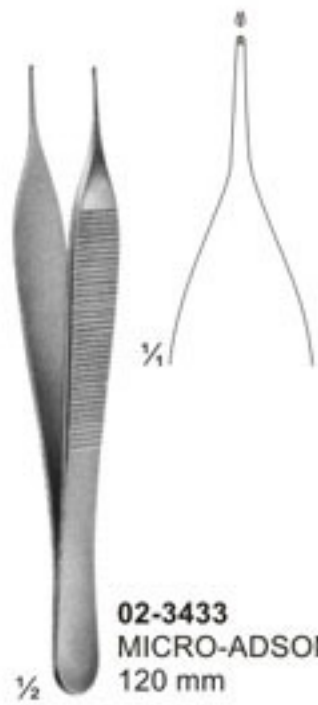
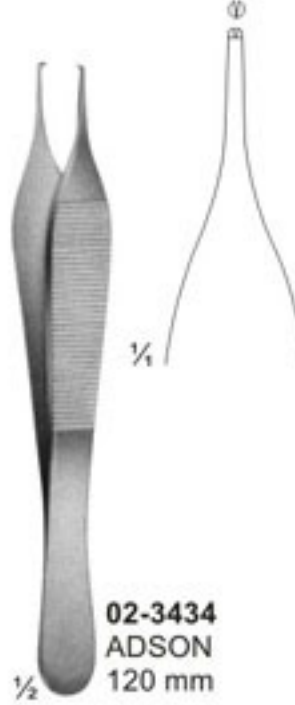
Delicate Tissue Forceps

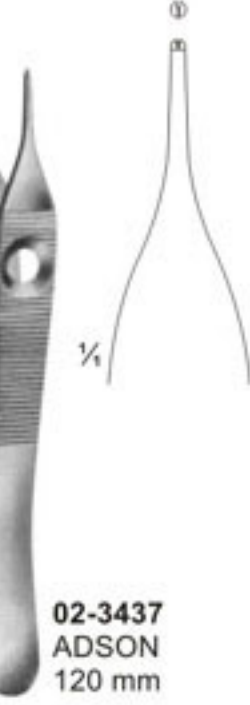
 <p>1/2</p>	 <p>1/4</p>	 <p>1/4</p>	 <p>1/4</p>	 <p>1/4</p>
<p>02-3421 BISHOP-HARMON 85 mm</p>	<p>02-3422 ST.MARTIN 80 mm</p>	<p>02-3423 CASTROVIEJO teeth 0.9 mm 100 mm</p>	<p>02-3424 CASTROVIEJO teeth 0.5 mm 100 mm</p>	<p>02-3425 ELSCHING 110 mm</p>
 <p>1/4</p>	 <p>1/4</p>	 <p>1/4</p>	 <p>1/4</p>	 <p>1/4</p>
<p>02-3426 GILL 75 mm</p>	<p>02-3427 GILL - HESS 75 mm</p>	<p>02-3428 HESS 70 mm</p>	<p>02-3429 ARRUGA 100 mm</p>	<p>02-3430 - 02-3432 SEMKEN 125 mm 2 x 125 mm 125 mm</p>
 <p>1/4</p>	 <p>1/4</p>	 <p>1/4</p>	 <p>1/4</p>	 <p>1/4</p>
<p>02-3433 MICRO-ADSON 120 mm</p>	<p>02-3434 ADSON 120 mm</p>	<p>02-3435 ADSON 120 mm</p>	<p>02-3436 ADSON 120 mm</p>	<p>02-3437 ADSON 120 mm</p>



Tissue Forceps

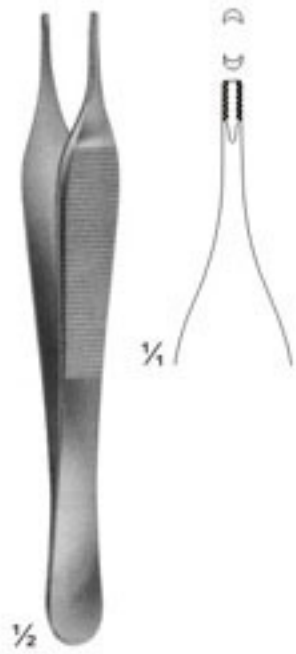

02-3438
ADSON - BROWN
Non-traumatic
120 mm

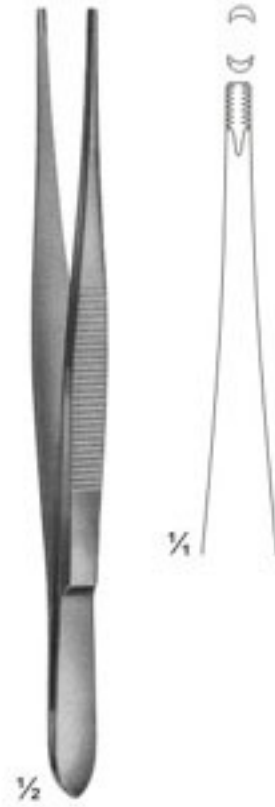

02-3439
BROWN
150 mm



02-3440
GRAEFE
110 mm



02-3441
GRAEFE
With Catch
110 mm

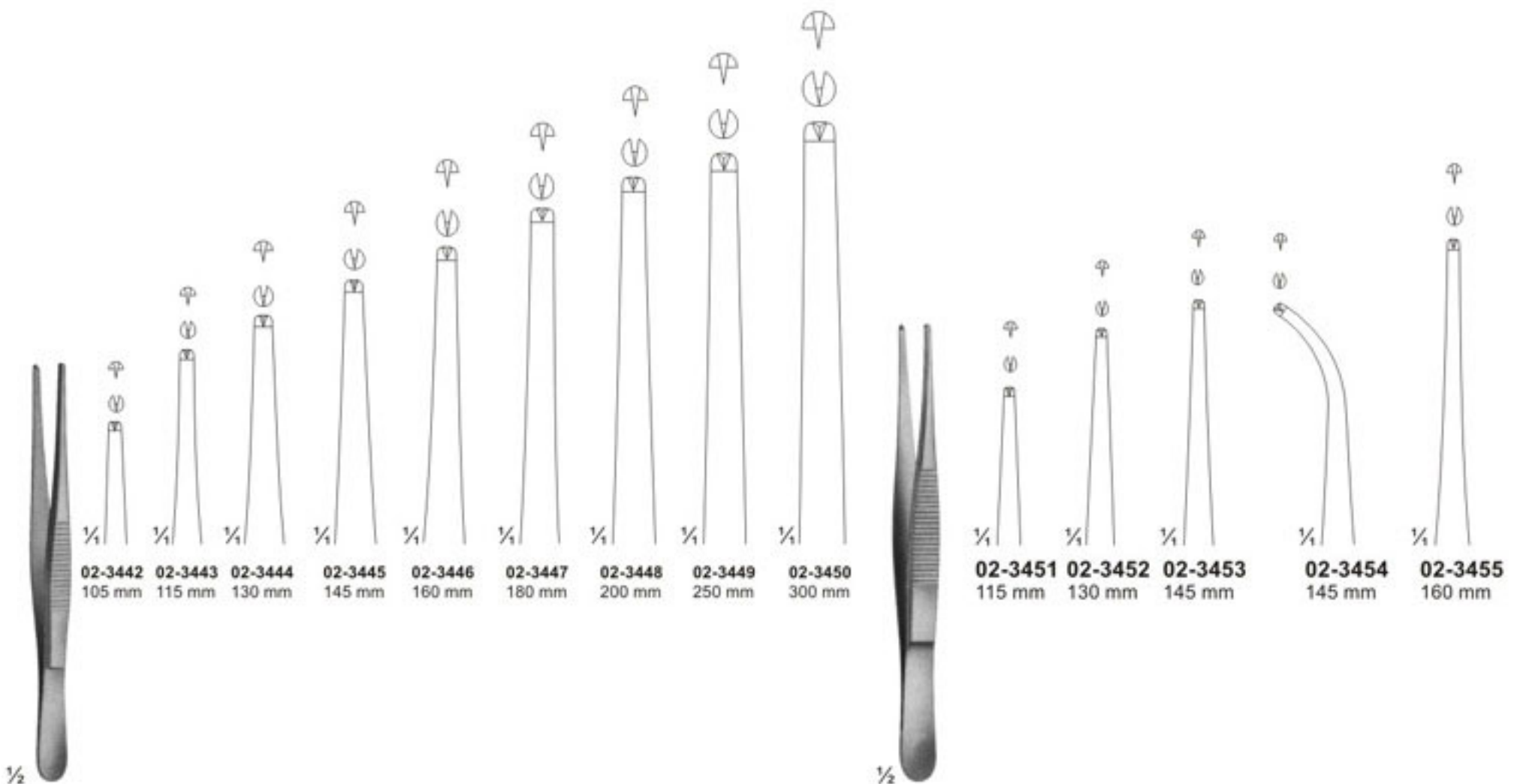

02-3442 - 02-3450
STANDARD

02-3451 - 02-3455
Medium



Tissue Forceps

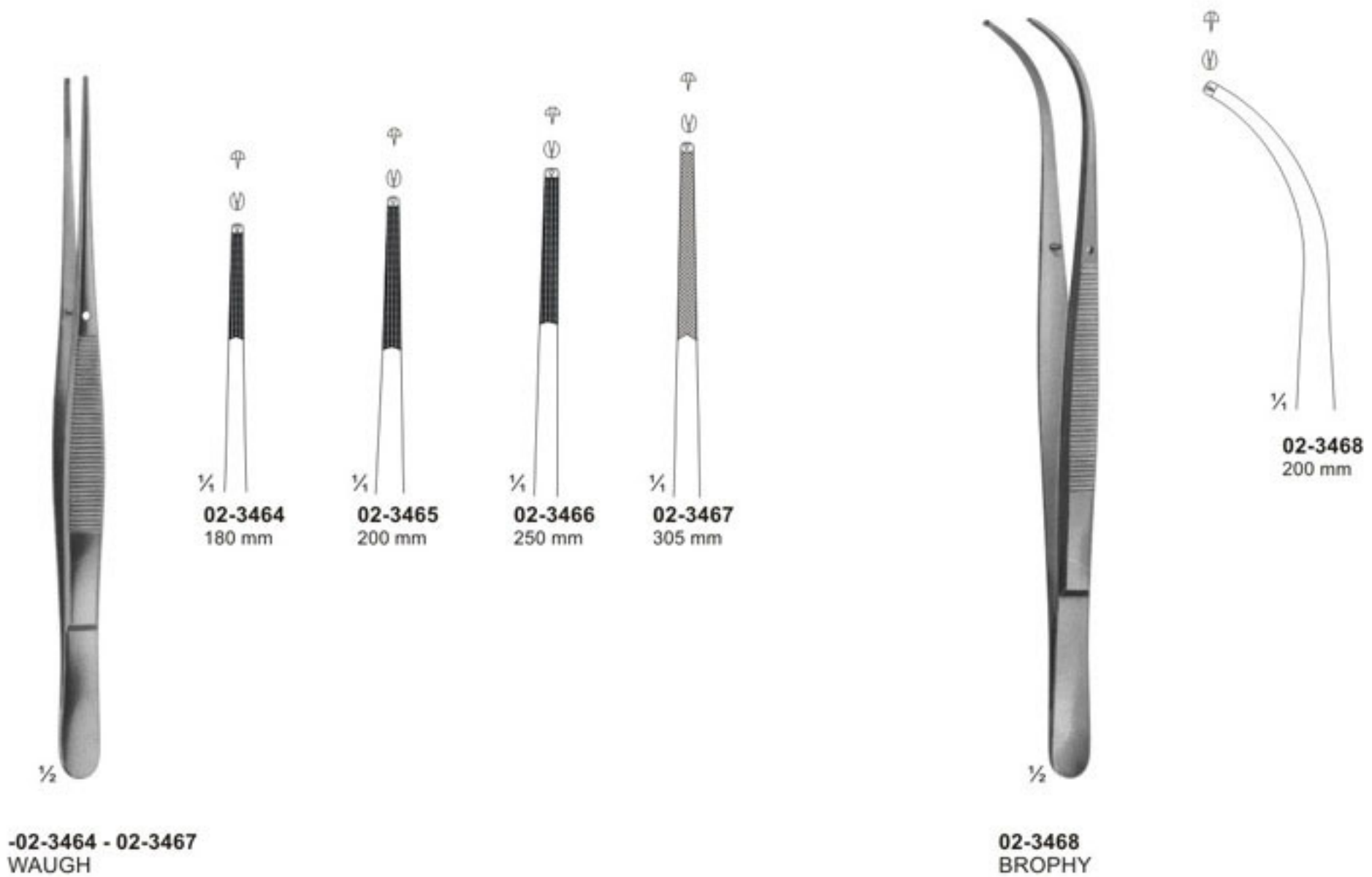
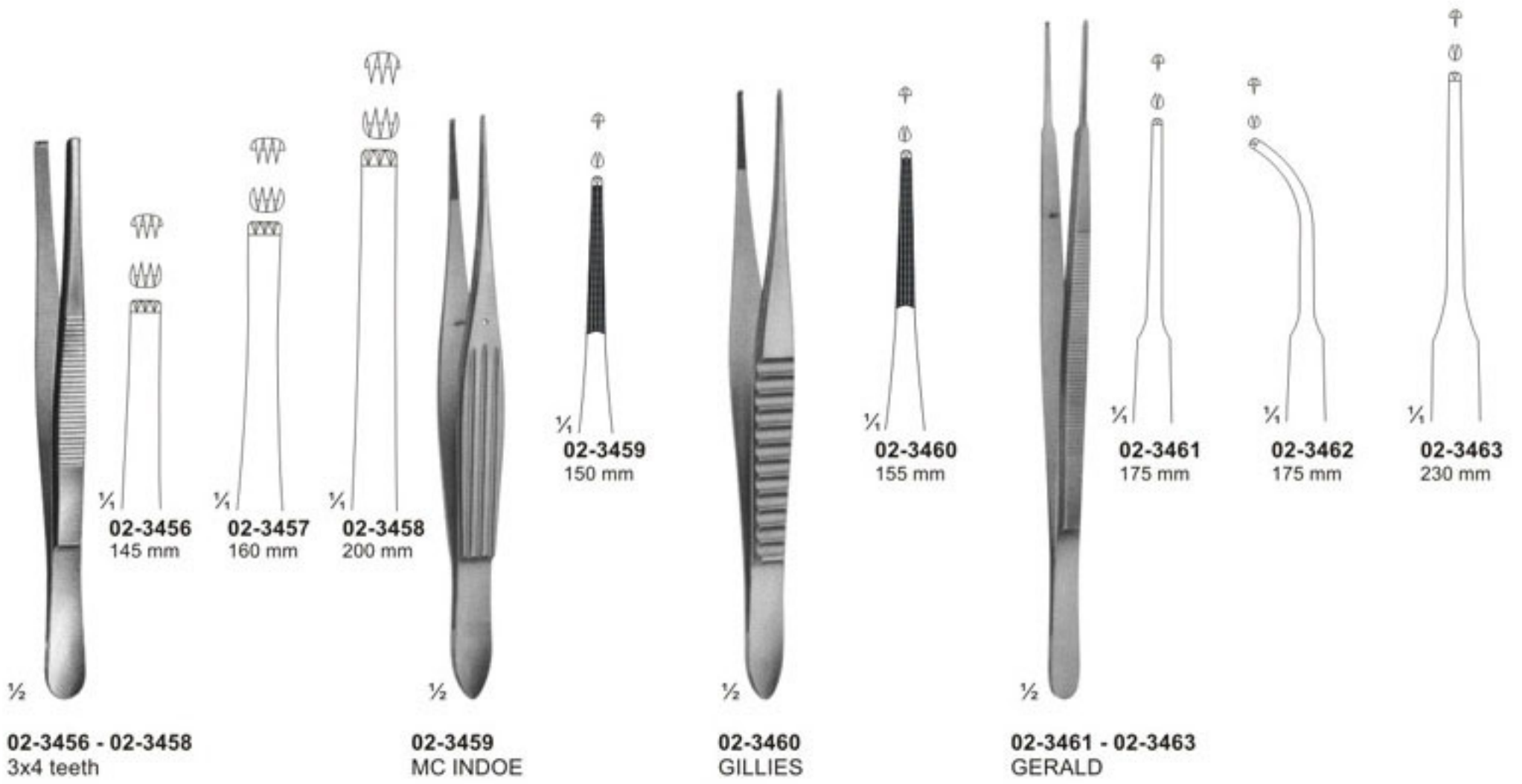



Tissue Forceps, Lung Dissecting Forceps, Intestinal Forceps

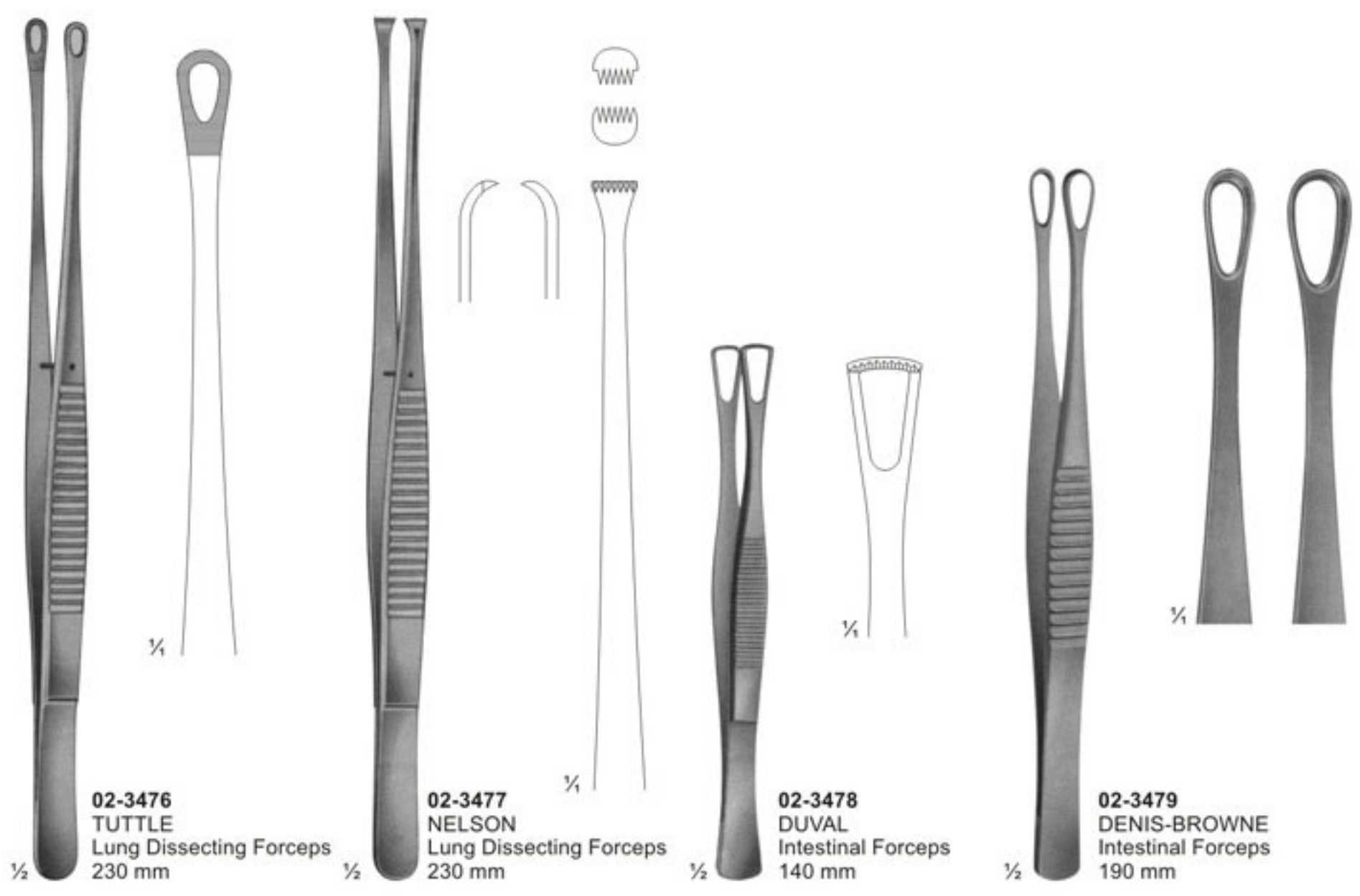
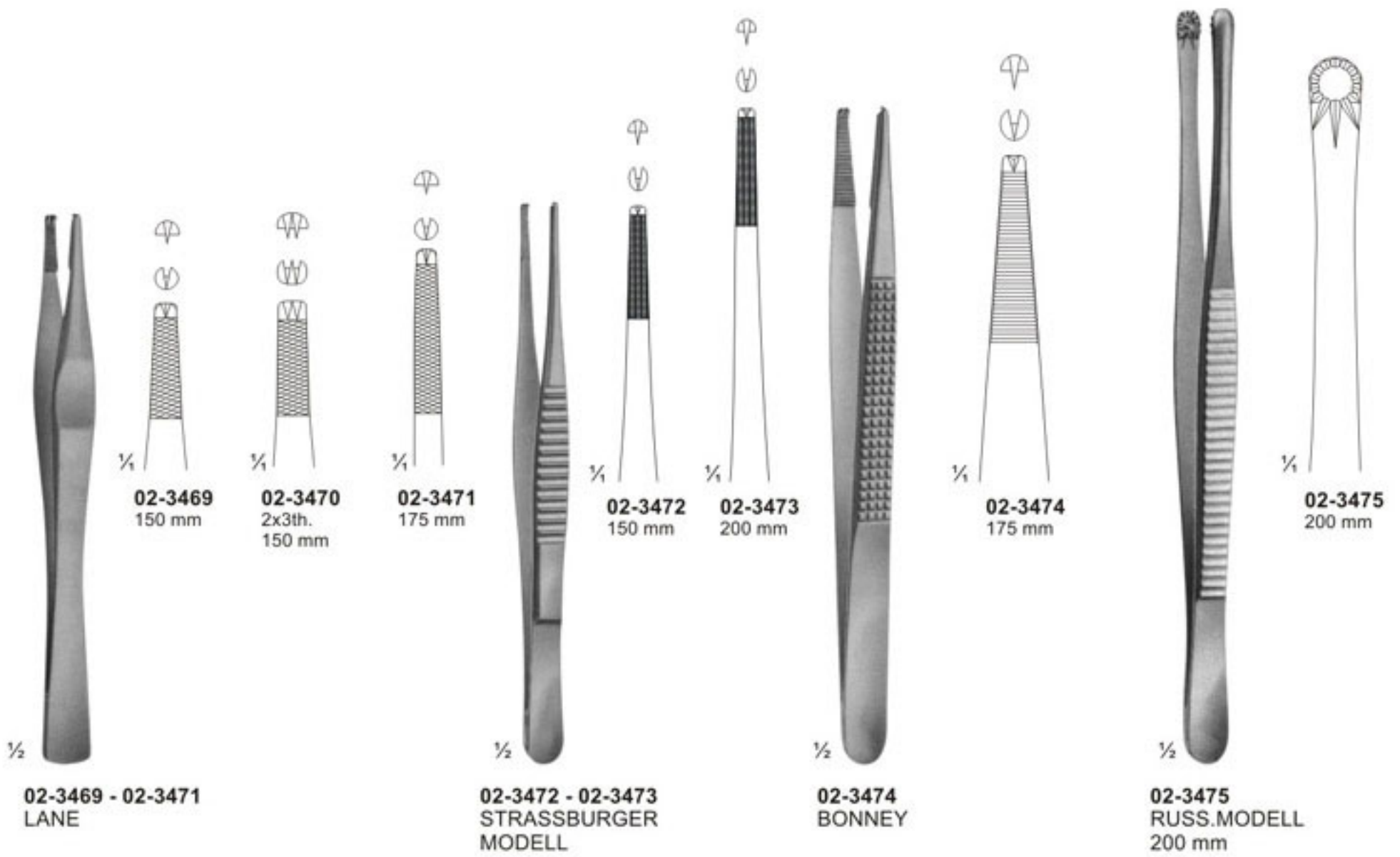



Splinter and Cilia Forceps

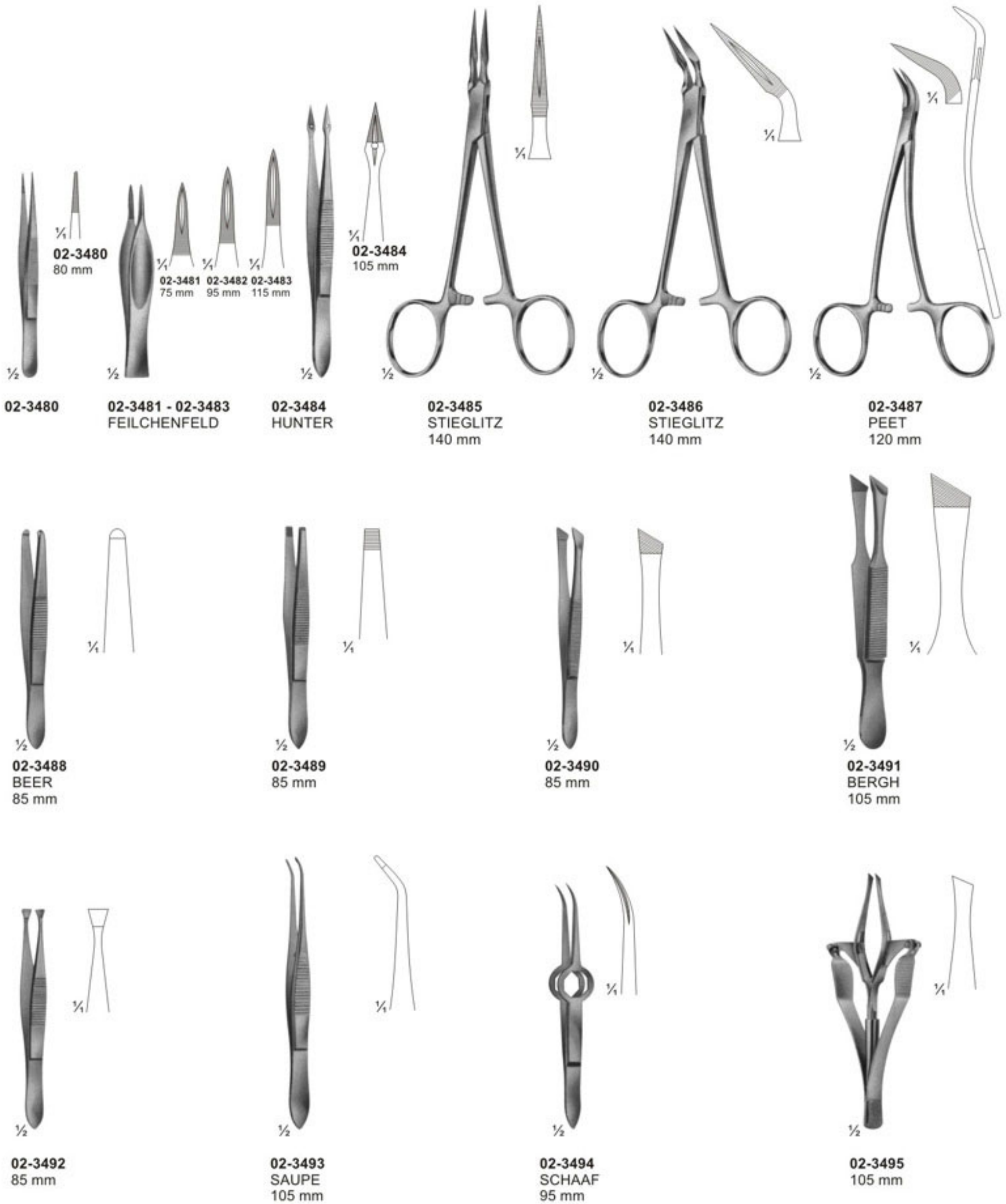



Sponge and Dressing Forceps



02-3496
BRYANT
130 mm



02-3497 - 02-3499
LISTER
Sinus Forceps

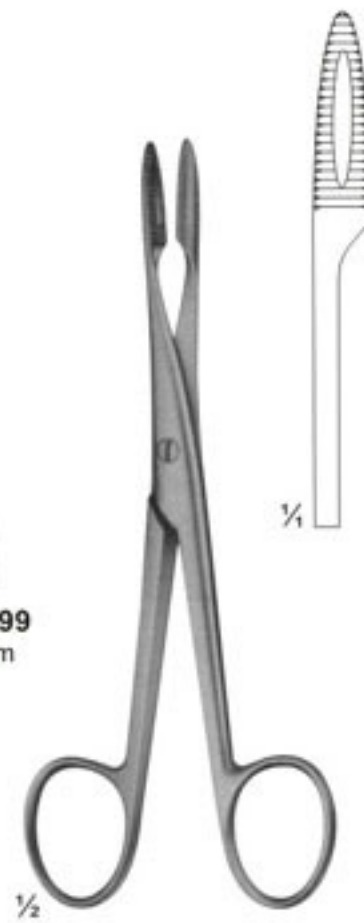

02-3500
Without Ratchet
145 mm

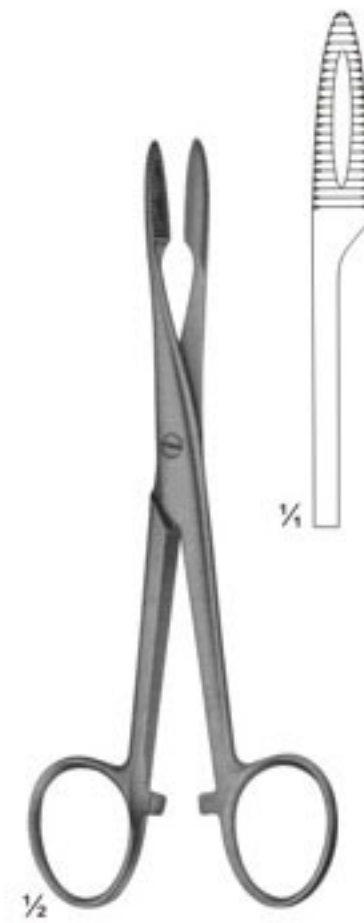

02-3501
With Ratchet
145 mm

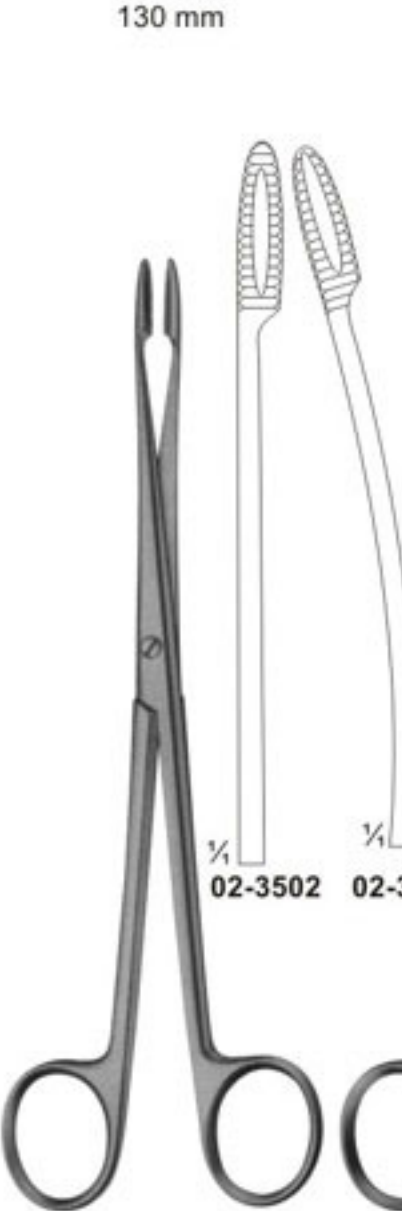

02-3502 - 02-3503
GROSS
Without Ratchet
180 mm

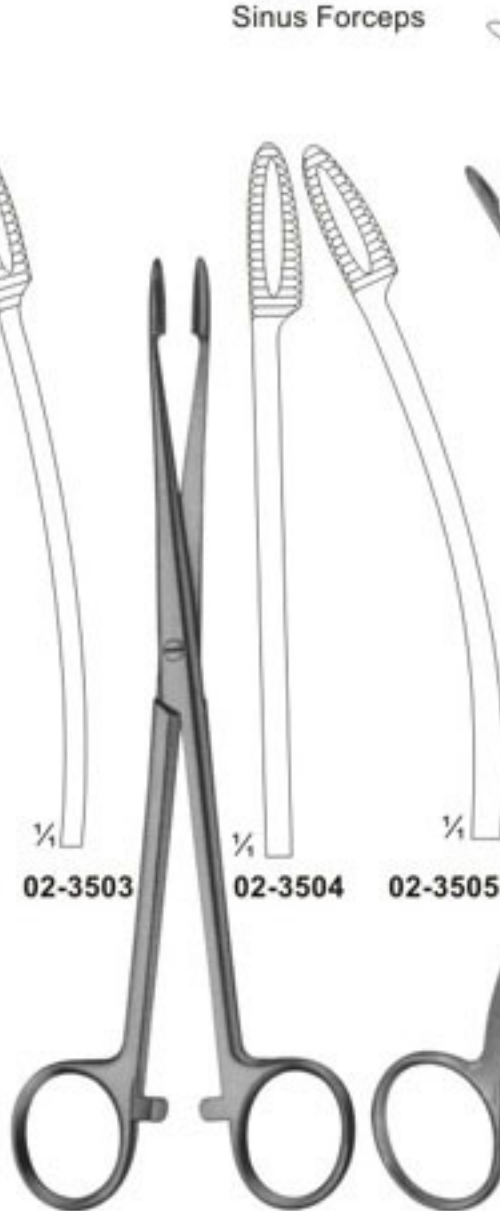

02-3504 - 02-3505
GROSS
With Ratchet
180 mm

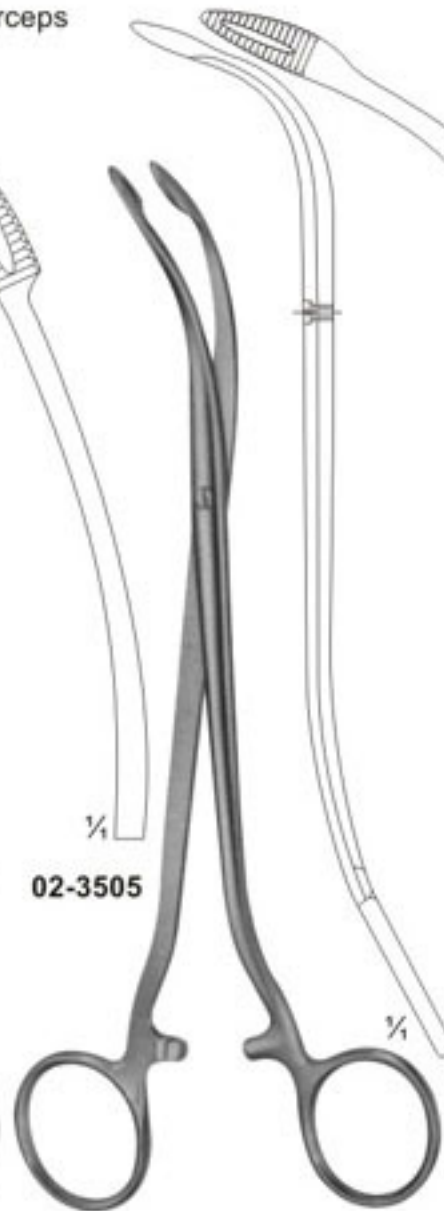

02-3506
DUPLAY
190 mm

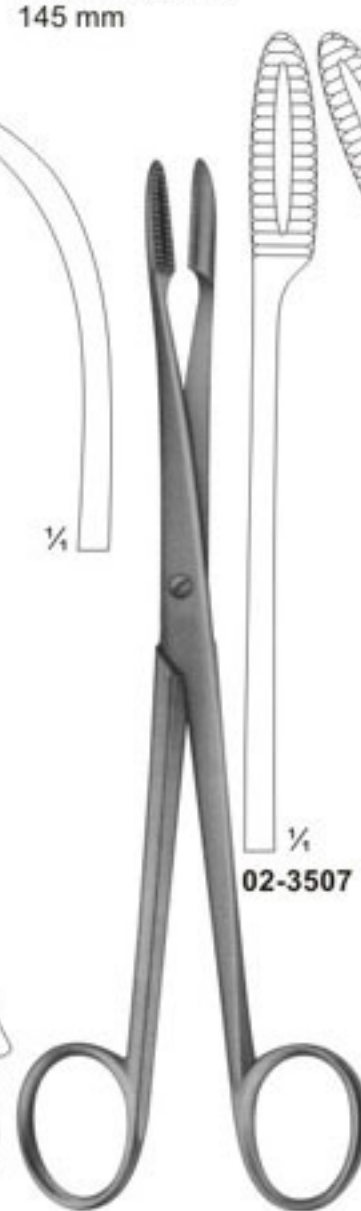

02-3507 - 02-3508
GROSS
Without Ratchet
200 mm

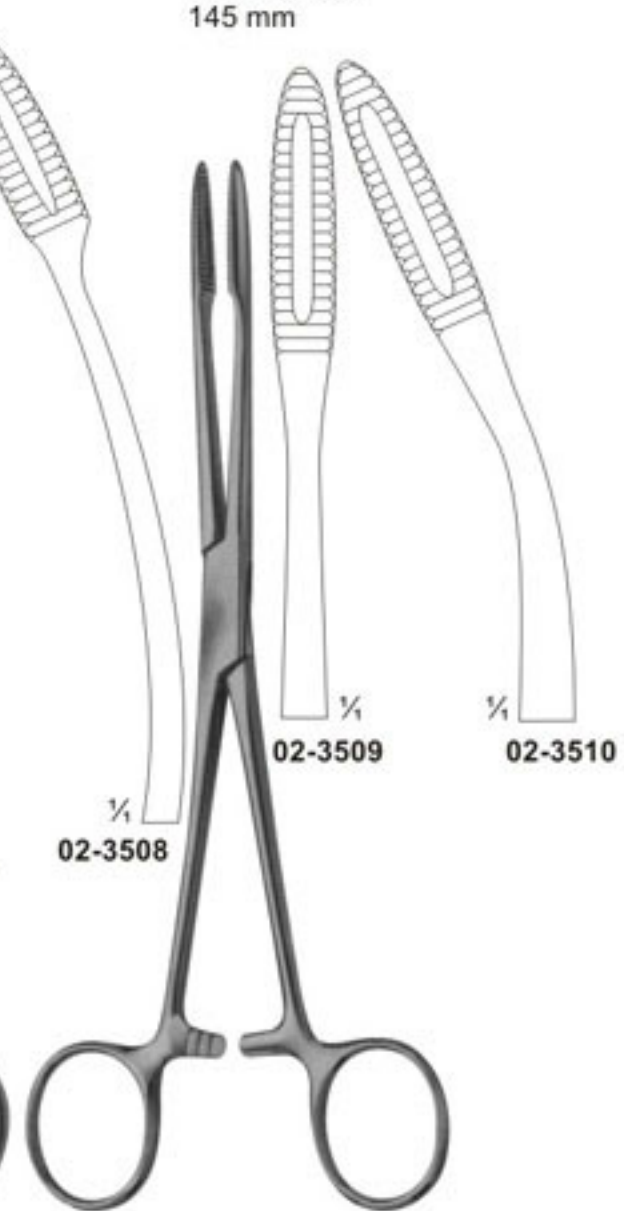

02-3509 - 02-3510
GROSS
With Ratchet
200 mm



Sponge and Dressing Forceps



02-3511 - 03-3512
ALM
220 mm

02-3513 - 02-3514
MAIER
Without Ratchet
265 mm

02-3515 - 02-3516
MAIER
With Ratchet
265 mm



Sponge and Dressing Forceps

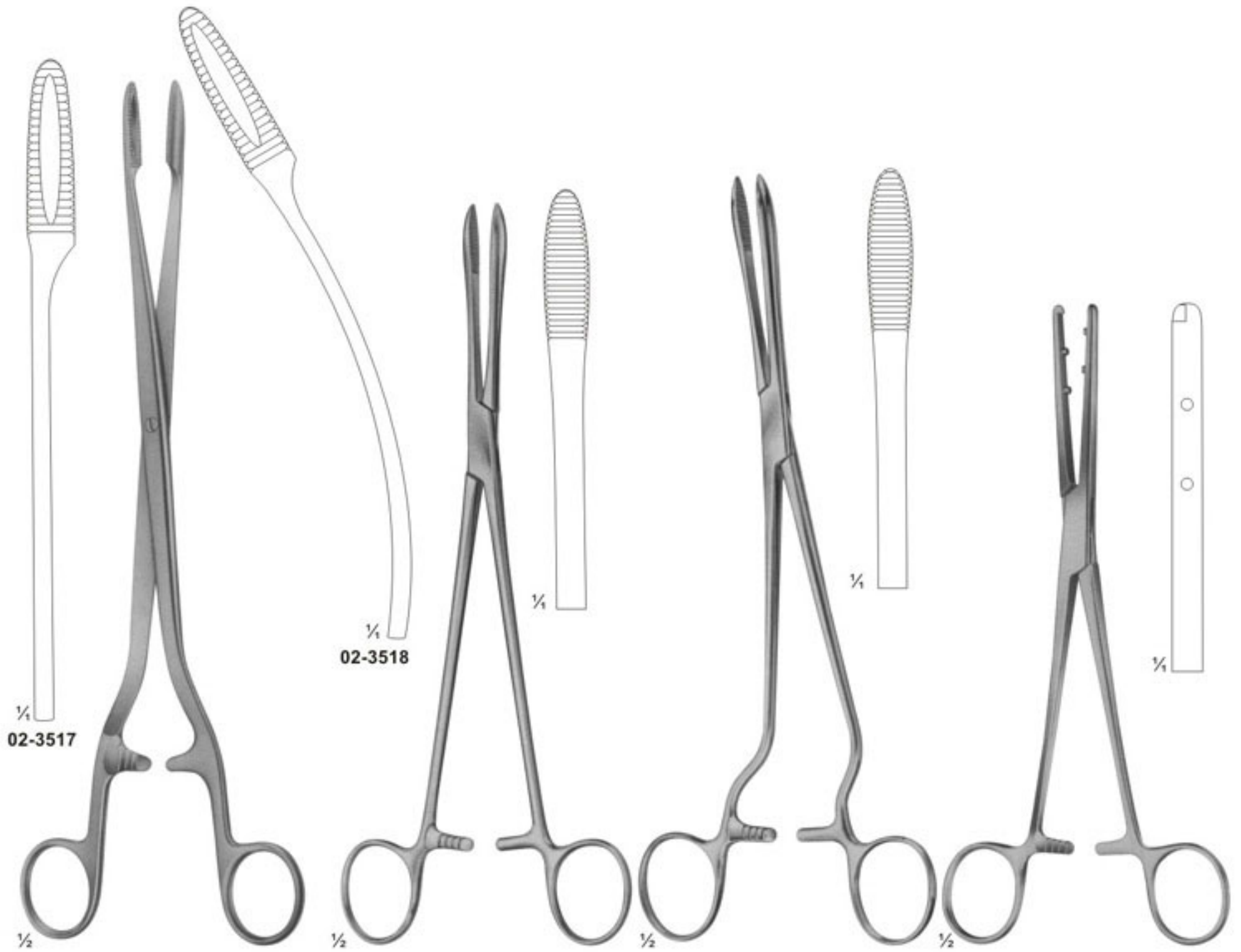

1/4
02-3517

1/4
02-3518

1/4

1/4

1/4

1/2

1/2

1/2

1/2

02-3517 - 02-3518
SIMS-MAIER
280 mm

02-3519
COLLIN
240 mm

02-3520
CHERON
Handles Laterally Angled
240 mm

02-3521
EMMET
210 mm



Dressing, Sponge Holding, Organ and Tissue Grasping Forceps and Haemostatic Forceps

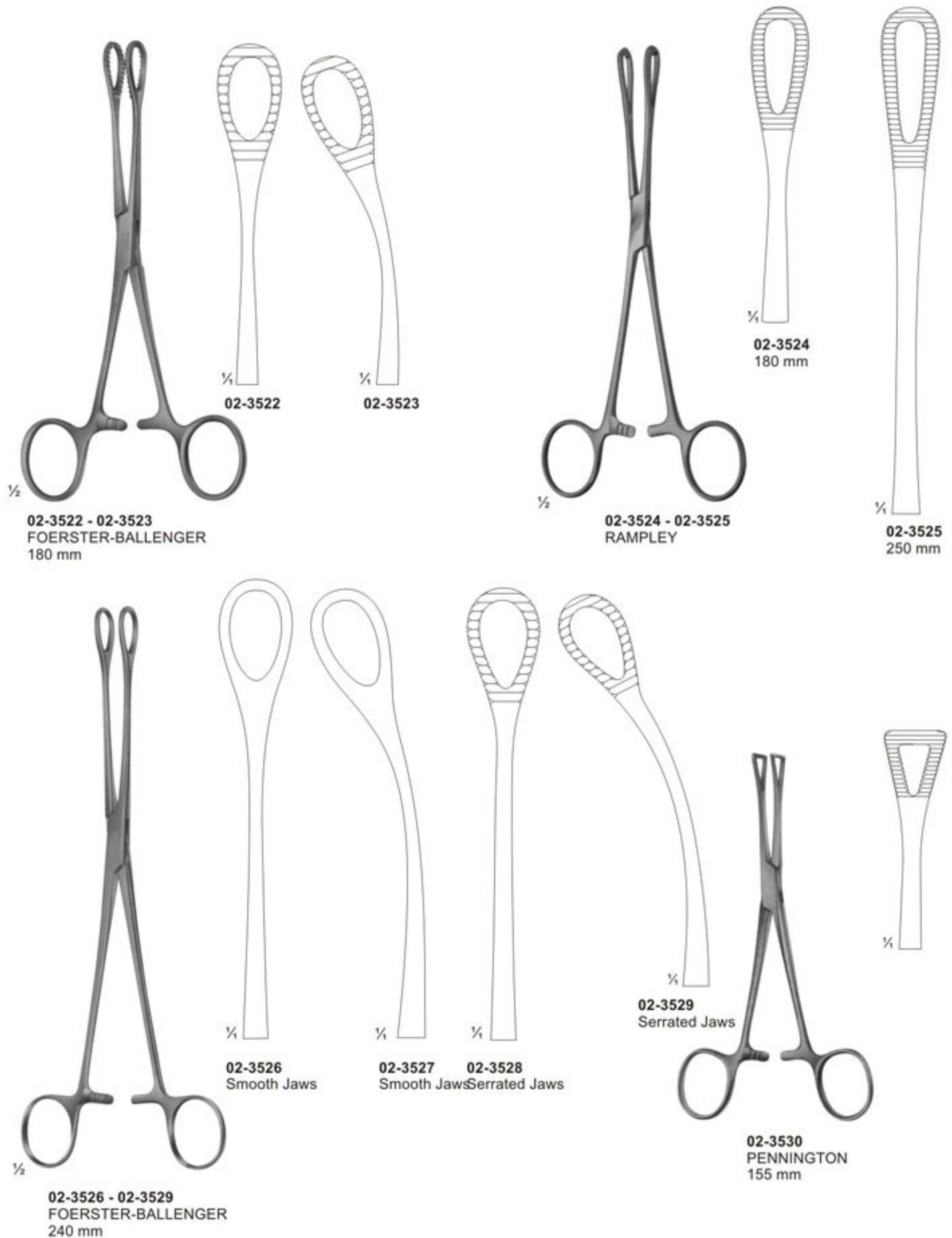



Dressing, Sponge holding, Organ and Tissue Grasping Forceps

ATRAUMATA



02-3531 - 02-3532
COLLIN



02-3531
195 mm



02-3532
230 mm

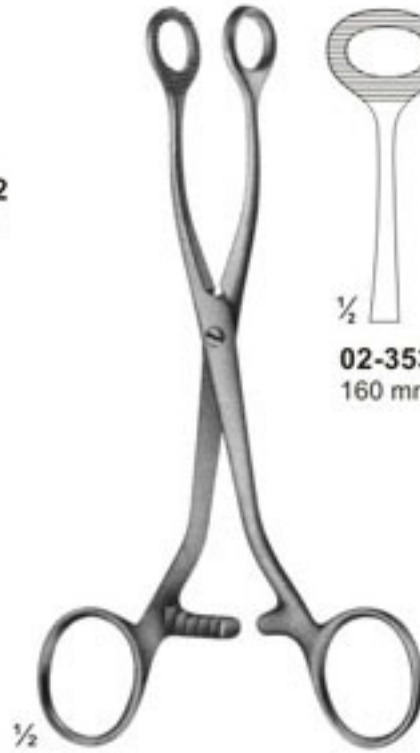

02-3533 - 02-3535
COLLIN



02-3533
160 mm



02-3534
160 mm



02-3535
170 mm

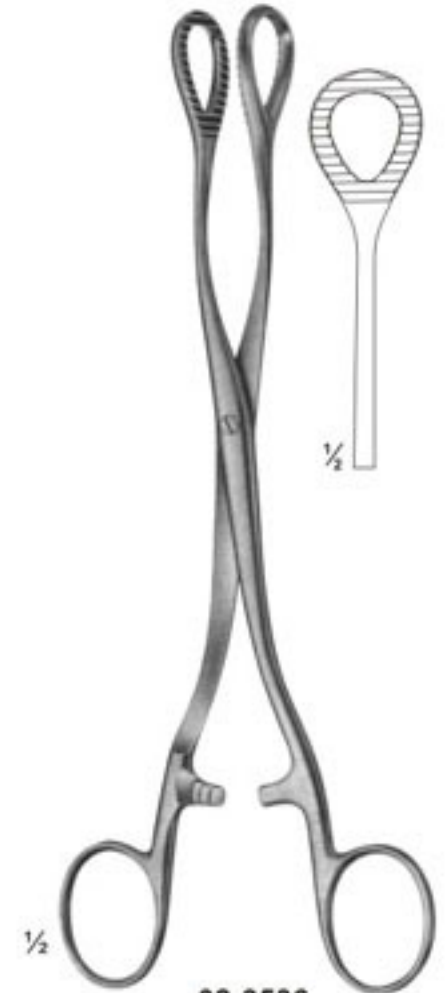

02-3536
HEYWOOD-SMITH
200 mm



02-3537
NOTO
280 mm



02-3538
KELLY
320 mm



1/4



Tendon Seizing Forceps



02-3539

02-3540

1/2
02-3539 - 02-3540
HERZ
155 mm



02-3541

1/2
02-3541
JACKSON
4 x 5 teeth
150 mm



1/2
02-3542
Tendon interlacing
forceps
150 mm



1/2
02-3543
Tendon interlacing
forceps
150 mm

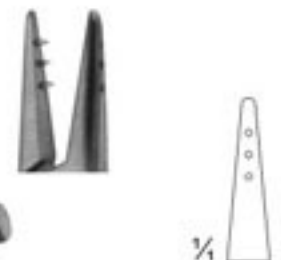

1/2
02-3544
Tendon seizing
forceps
120 mm

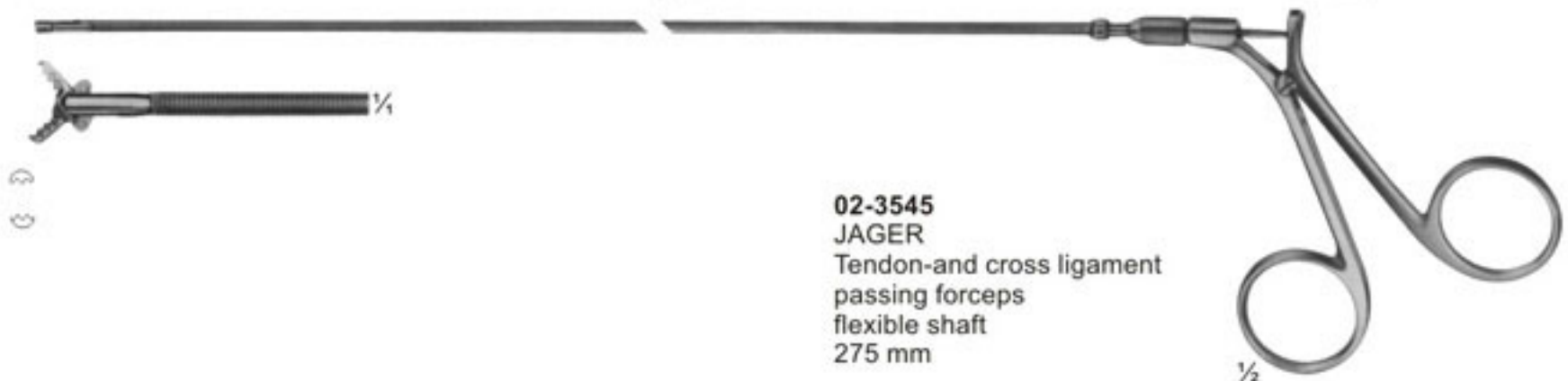

02-3545
JAGER
Tendon-and cross ligament
passing forceps
flexible shaft
275 mm



Artery Traction - and Tissue Grasping Forceps

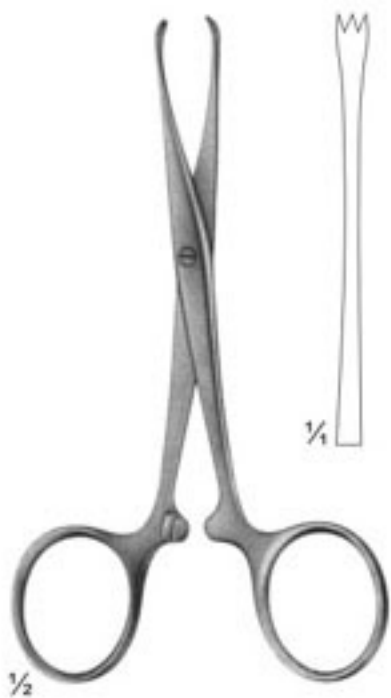

02-3546
CHAPUT
2 x 3 teeth sharp
125 mm

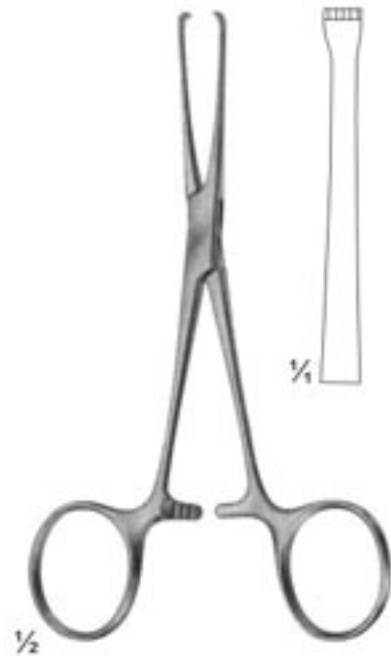

02-3547
BABY-ALLIS
4 x 5 teeth
130 mm

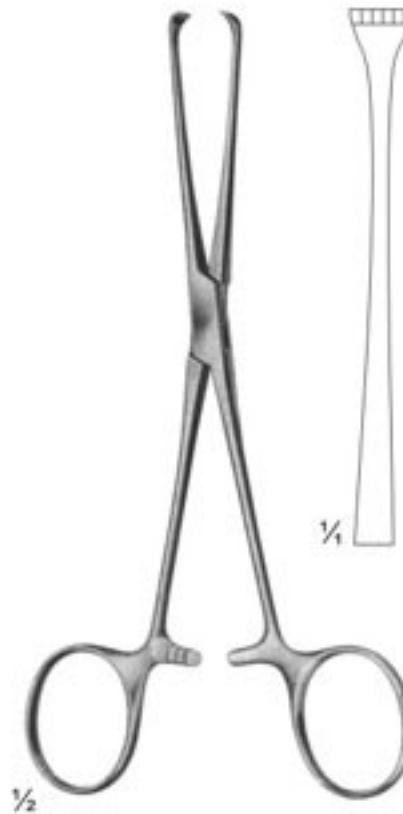

02-3548
BOYS-ALLIS
5 x 6 teeth sharp
155 mm

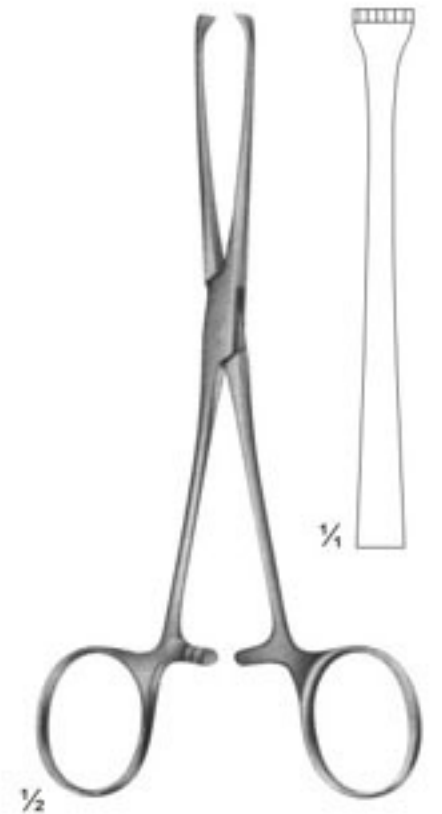

02-3549
ALLIS
5 x 6 teeth blunt
155 mm



02-3550
LAHEY
155 mm

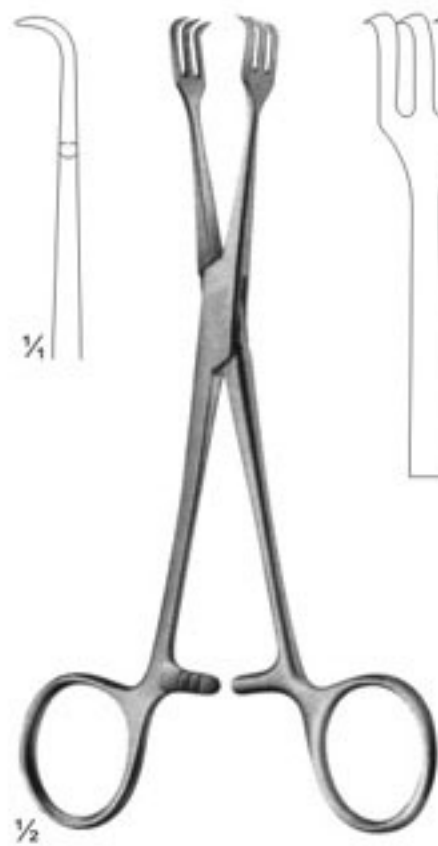

02-3551
LAHEY
155 mm

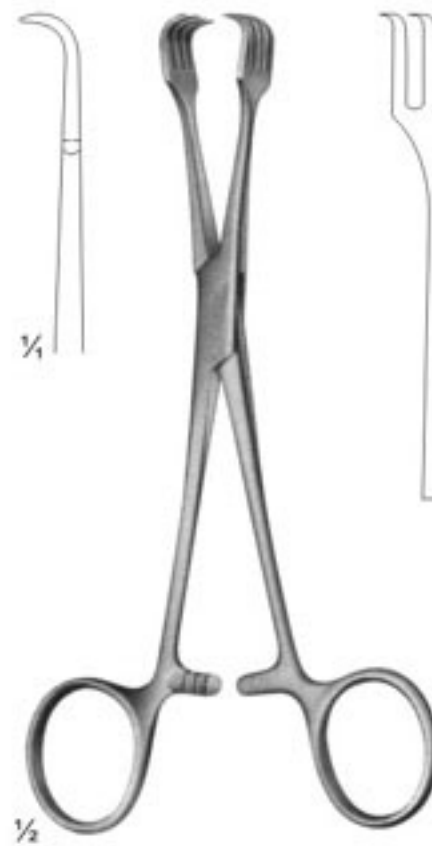

02-3552
BRAUN
155 mm

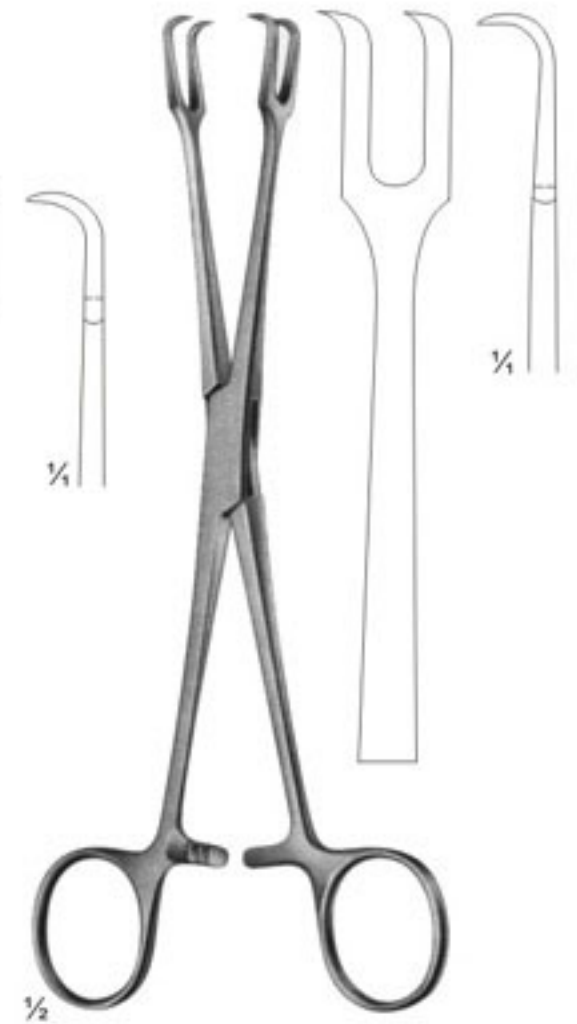

02-3553
MUSEUX
200 mm



Organ - and Tissue Grasping Forceps

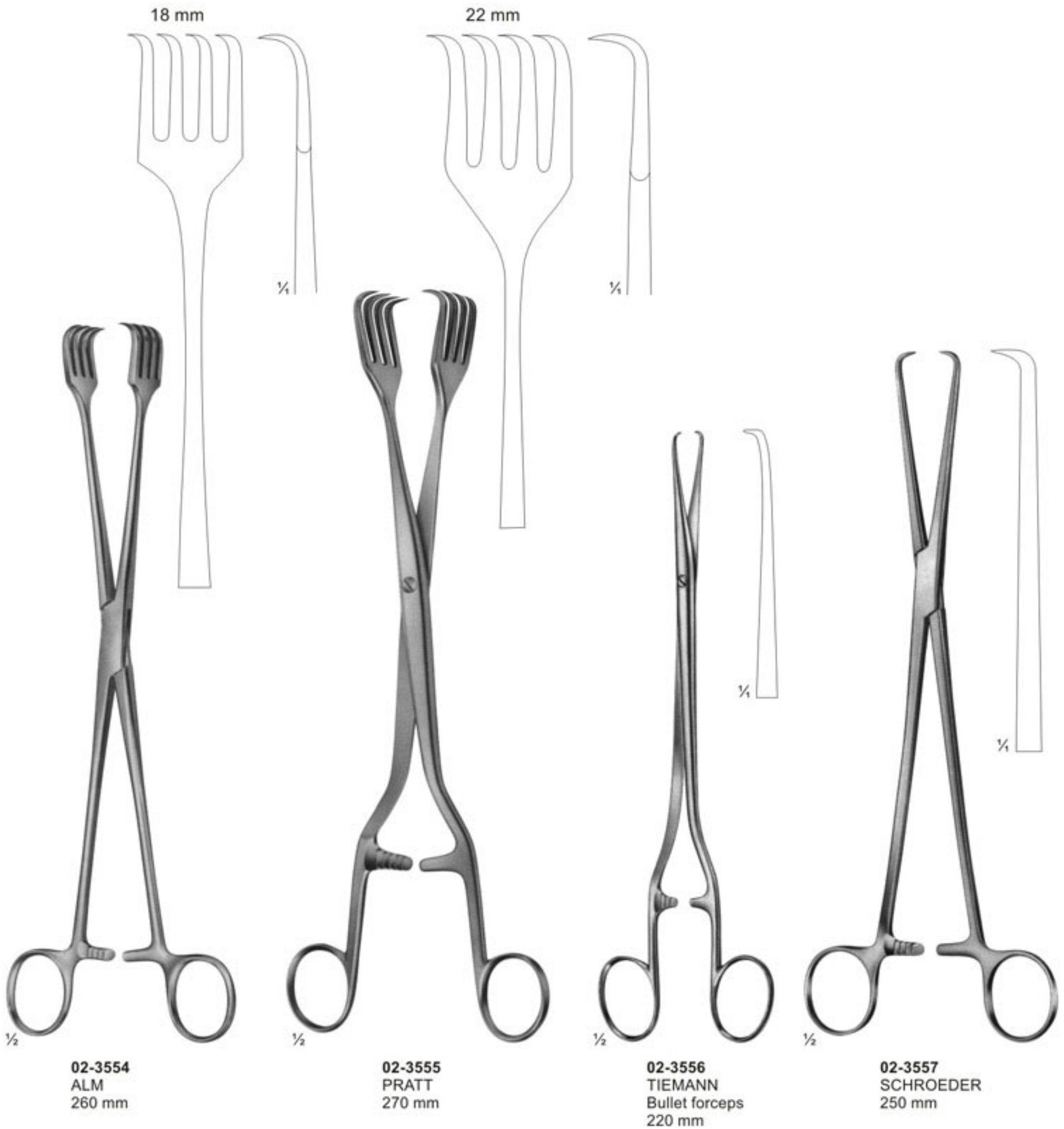



Towel Clamps



02-3558
JONES
85 mm



02-3559
ENGL.MOD.
85 mm

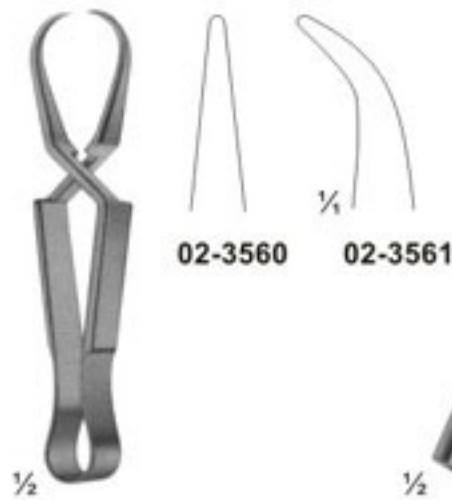

02-3560 - 02-3561
SCHAEDEL
85 mm



02-3562
DOYEN
110 mm



02-3563
DOYEN
180 mm

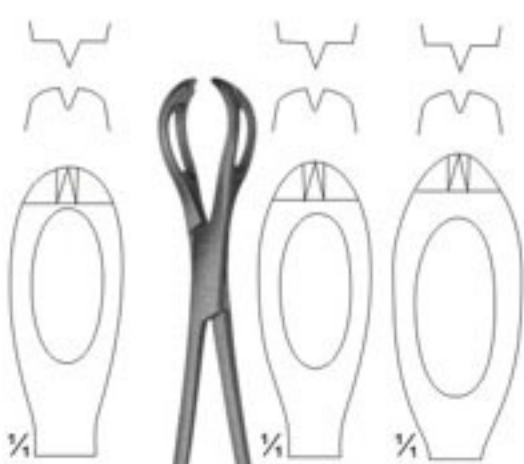

02-3564
130 mm

02-3565
155 mm

02-3566
195 mm



02-3567
80 mm

02-3568
105 mm

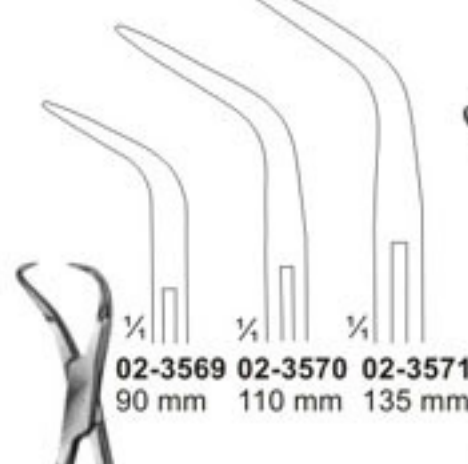

02-3569
90 mm

02-3570
110 mm

02-3571
135 mm



02-3572
BACKHAUS-KOCHER
135 mm

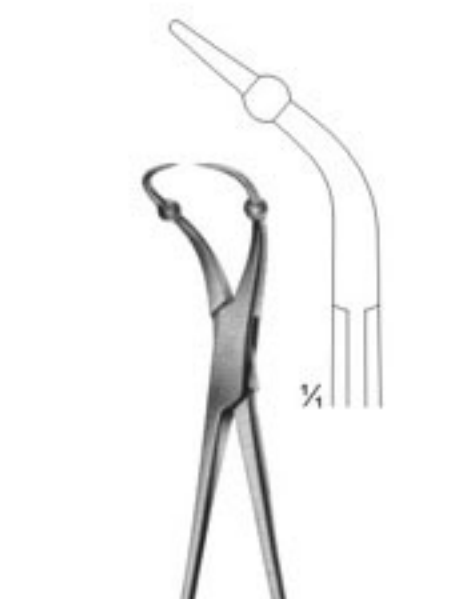

02-3573
ROEDER
160 mm



Towel Clamps and Safety Pins.



02-3574
ROBIN
with holders for tubing
up to 13 mm
135 mm



02-3575
with clip for tubing
up to 15 mm
110 mm



02-3576
LORNA
non perforating
130 mm



02-3577
for paper cloths
140 mm



02-3578
BUNT
105 mm



02-3579
MAYO
140 mm



Muller Vessel Clips and Bulldog Clamps

Closing force



02-3580
Straight
50g



02-3581
80g



02-3582
Curved
50g



02-3583
80g



02-3584
Curved tips
50g



02-3585
80g



02-3586
Angled
Shaped
50g



02-3587
80g



02-3588
Muller
Knee-bent
50g



02-3589
80g



02-3590
Muller
Ligature Forceps



Jaw, cross
serrated
Jaws profiles
finally cross-
serrated.

Non-traumatic vessel clips, temporary.



02-3591
38 mm
48 mm



02-3592
38 mm
48 mm



02-3593
58 mm



02-3594
58 mm



02-3595 - 02-3601















- 02-3595 38 mm
- 02-3596 48 mm
- 02-3597 56 mm
- 02-3598 63 mm
- 02-3599 70 mm
- 02-3600 80 mm
- 02-3601 91 mm

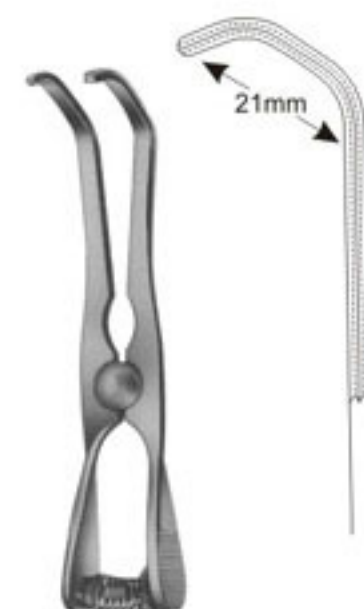

02-3602
DE BAKEY-
HESS
Length of
Jaws 20 mm



Bulldog Clamps

 <p>02-3603 35 mm</p>	 <p>02-3604 35 mm</p>	 <p>02-3605 45 mm</p>	 <p>02-3606 45 mm</p>	<p>DE BAKEY</p>  <p>02-3607 Length 50 mm Jaws 27 mm</p>	<p>DE BAKEY</p>  <p>02-3608 Length 48 mm Jaws 27 mm</p>																																																						
 <p>02-3609 GLOVER Length 57 mm Jaws 35 mm</p>	 <p>02-3610 DE BAKEY Length 73 mm Jaws 38 mm</p>	 <p>02-3611 DE BAKEY Length 99 mm Jaws 63 mm</p>	 <p>02-3612 DE BAKEY Length 95 mm Jaws 54 mm</p>																																																								
 <p>DE BAKEY</p> <table border="0"> <tr> <td></td> <td>Total length</td> <td>Length of jaw</td> </tr> <tr> <td>02-3613</td> <td>80mm</td> <td>25mm</td> </tr> <tr> <td>02-3614</td> <td>90mm</td> <td>35mm</td> </tr> <tr> <td>02-3615</td> <td>105mm</td> <td>50mm</td> </tr> <tr> <td>02-3616</td> <td>124mm</td> <td>68mm</td> </tr> </table>		Total length	Length of jaw	02-3613	80mm	25mm	02-3614	90mm	35mm	02-3615	105mm	50mm	02-3616	124mm	68mm	 <p>DE BAKEY</p> <table border="0"> <tr> <td></td> <td>Total length</td> <td>Length of jaw</td> </tr> <tr> <td>02-3617</td> <td>78mm</td> <td>25mm</td> </tr> <tr> <td>02-3618</td> <td>86mm</td> <td>35mm</td> </tr> <tr> <td>02-3619</td> <td>97mm</td> <td>50mm</td> </tr> <tr> <td>02-3620</td> <td>114mm</td> <td>68mm</td> </tr> </table>		Total length	Length of jaw	02-3617	78mm	25mm	02-3618	86mm	35mm	02-3619	97mm	50mm	02-3620	114mm	68mm	 <p>GLOVER</p> <table border="0"> <tr> <td></td> <td>Total length</td> <td>Length of jaw</td> </tr> <tr> <td>02-3621</td> <td>68mm</td> <td>33mm</td> </tr> <tr> <td>02-3622</td> <td>96mm</td> <td>50mm</td> </tr> <tr> <td>02-3623</td> <td>117mm</td> <td>69mm</td> </tr> </table>		Total length	Length of jaw	02-3621	68mm	33mm	02-3622	96mm	50mm	02-3623	117mm	69mm	 <p>GLOVER</p> <table border="0"> <tr> <td></td> <td>Total length</td> <td>Length of jaw</td> </tr> <tr> <td>02-3624</td> <td>65mm</td> <td>33mm</td> </tr> <tr> <td>02-3625</td> <td>91mm</td> <td>50mm</td> </tr> <tr> <td>02-3626</td> <td>110mm</td> <td>69mm</td> </tr> </table>		Total length	Length of jaw	02-3624	65mm	33mm	02-3625	91mm	50mm	02-3626	110mm	69mm		
	Total length	Length of jaw																																																									
02-3613	80mm	25mm																																																									
02-3614	90mm	35mm																																																									
02-3615	105mm	50mm																																																									
02-3616	124mm	68mm																																																									
	Total length	Length of jaw																																																									
02-3617	78mm	25mm																																																									
02-3618	86mm	35mm																																																									
02-3619	97mm	50mm																																																									
02-3620	114mm	68mm																																																									
	Total length	Length of jaw																																																									
02-3621	68mm	33mm																																																									
02-3622	96mm	50mm																																																									
02-3623	117mm	69mm																																																									
	Total length	Length of jaw																																																									
02-3624	65mm	33mm																																																									
02-3625	91mm	50mm																																																									
02-3626	110mm	69mm																																																									



Delicate Haemostatic Forceps



02-3627
CARREL
85 mm

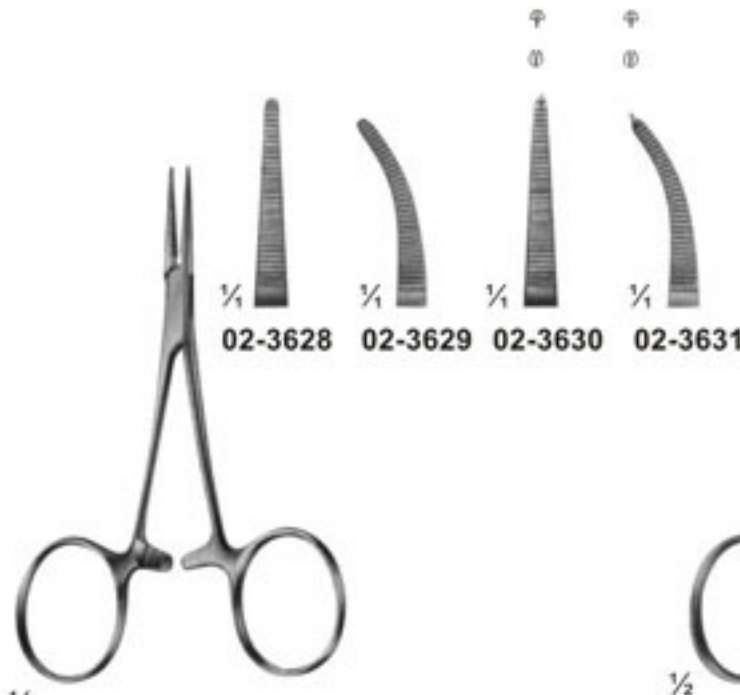

02-3628 - 02-3631
BABY-MOSQUITO
(HARTMANN)
100 mm

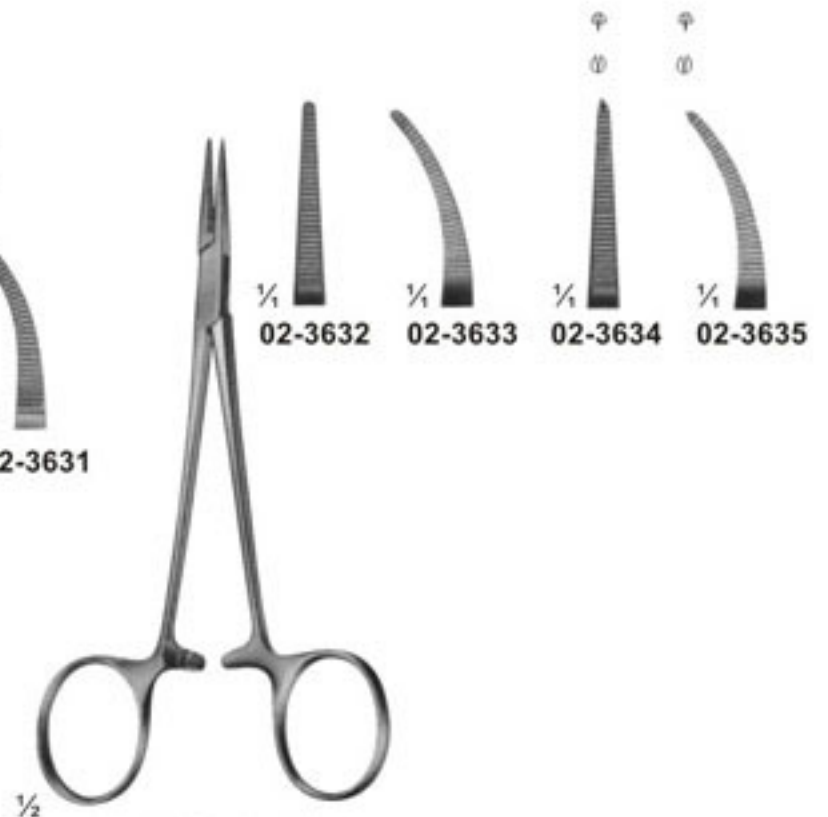

02-3632 - 02-3635
MICRO-HALSTED
125 mm



02-3636 - 02-3639
HALSTED-MOSQUITO
125 mm

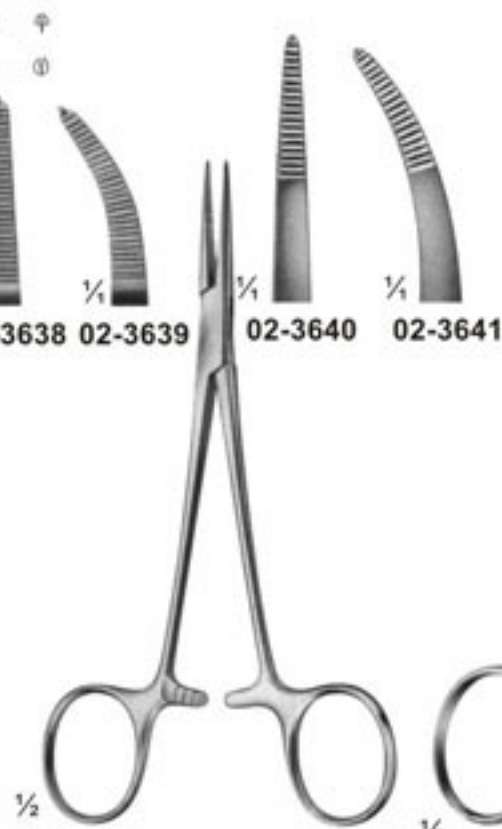

02-3640 - 02-3641
PROVIDENCE-HOSPITAL
140 mm

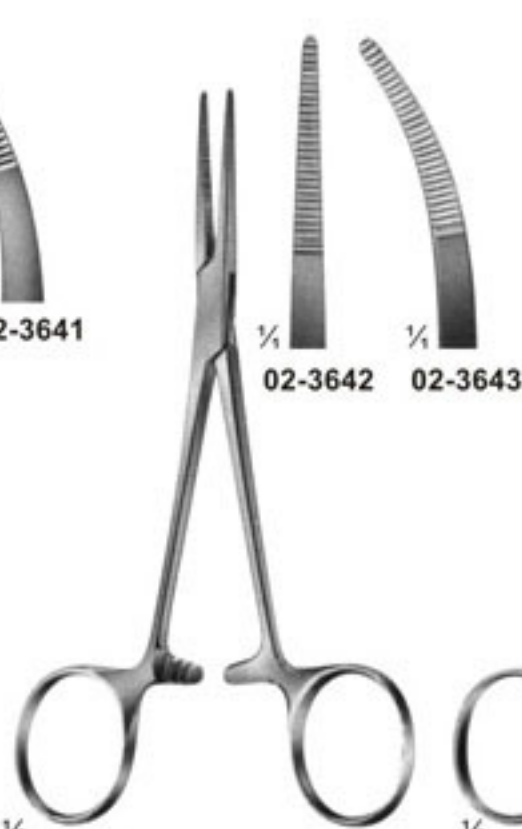

02-3642 - 02-3643
KELLY
140 mm

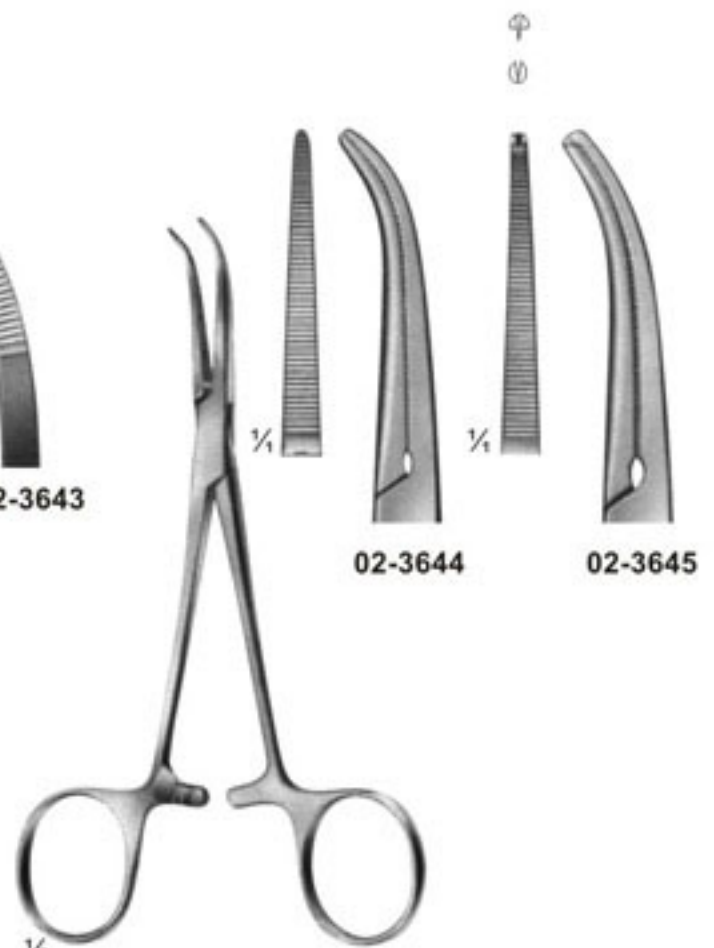

02-3644 - 02-3645
DANDY
Curved sideways
140 mm



Delicate Haemostatic Forceps

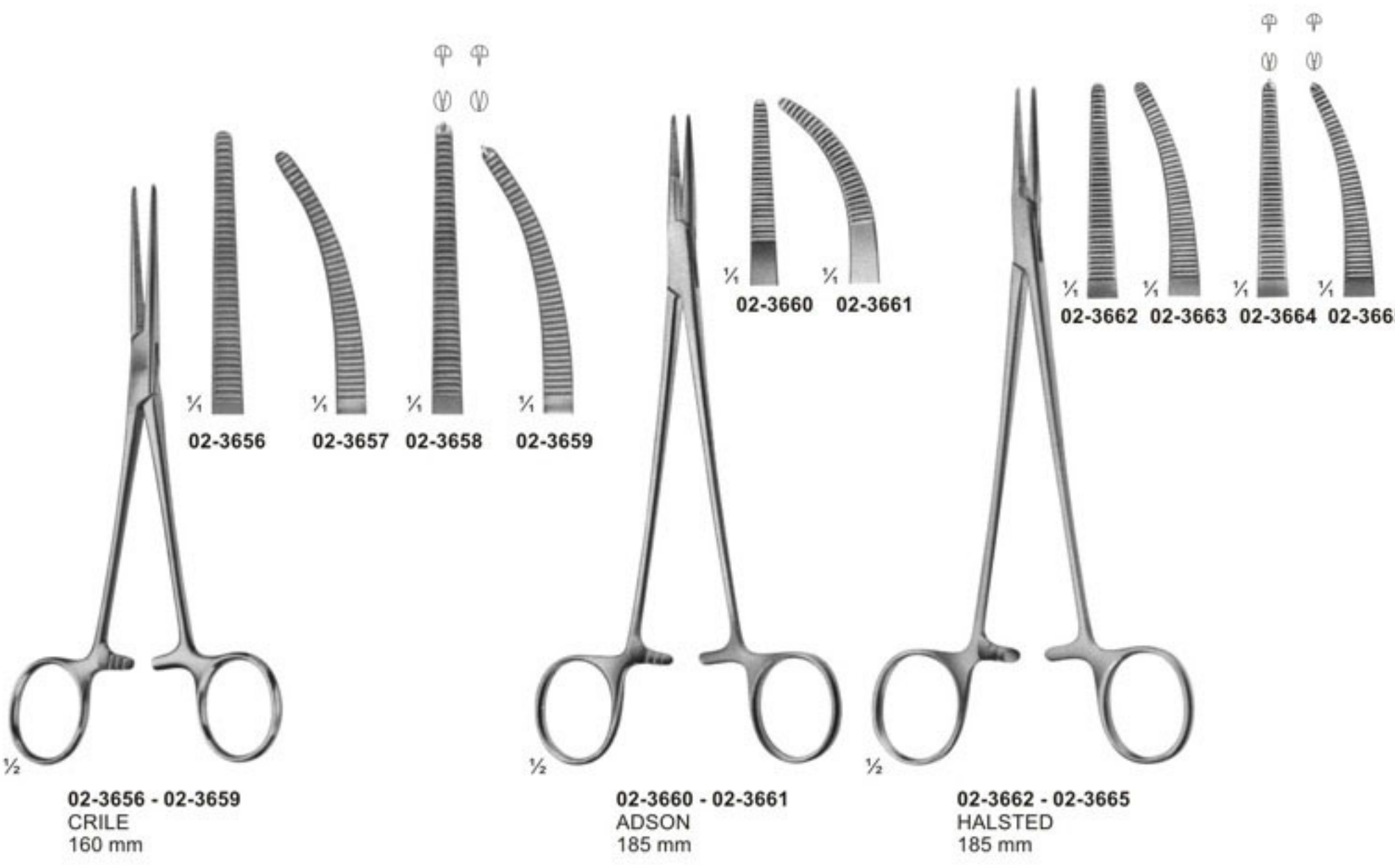
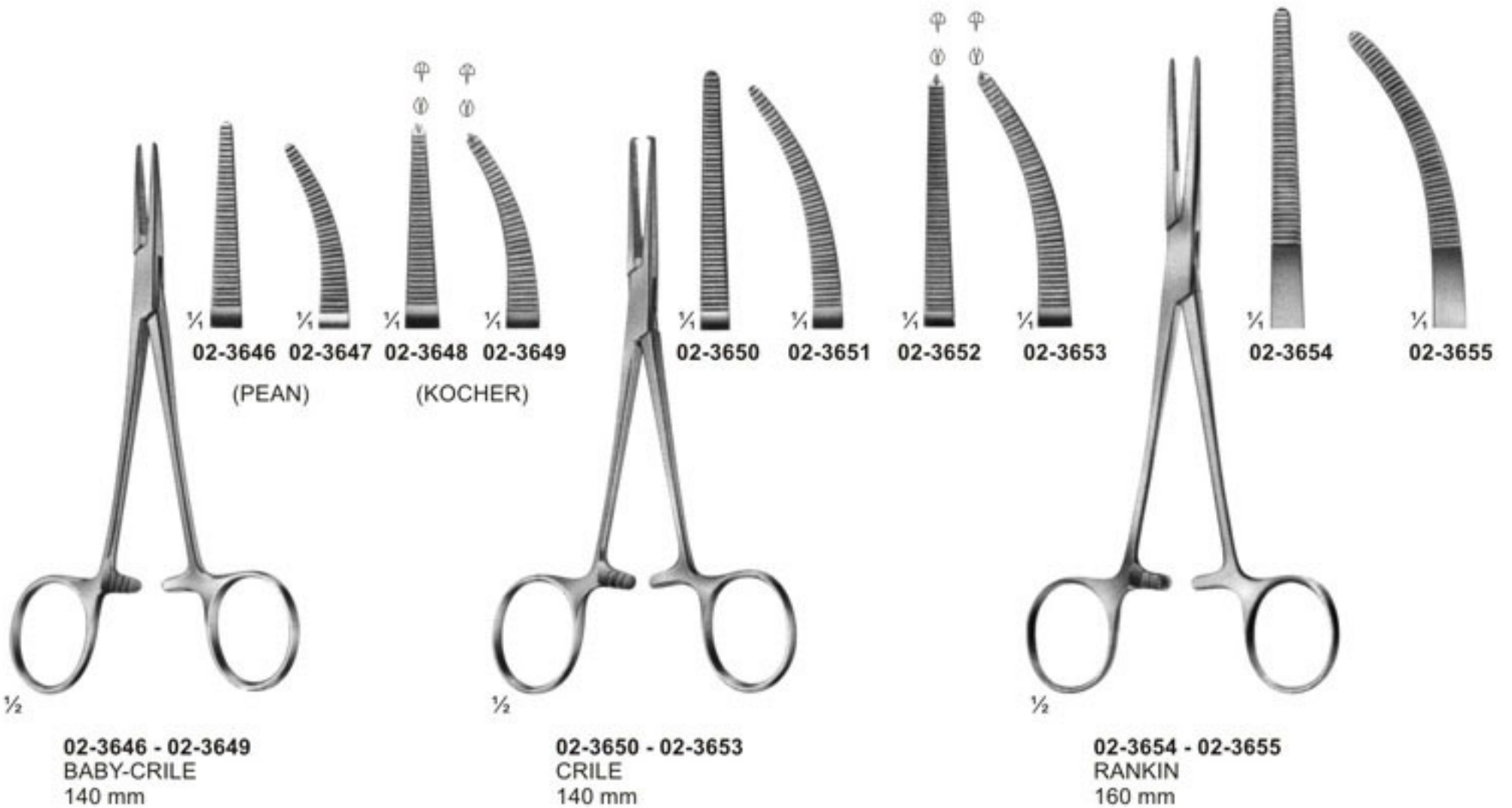



Delicate Haemostatic Forceps

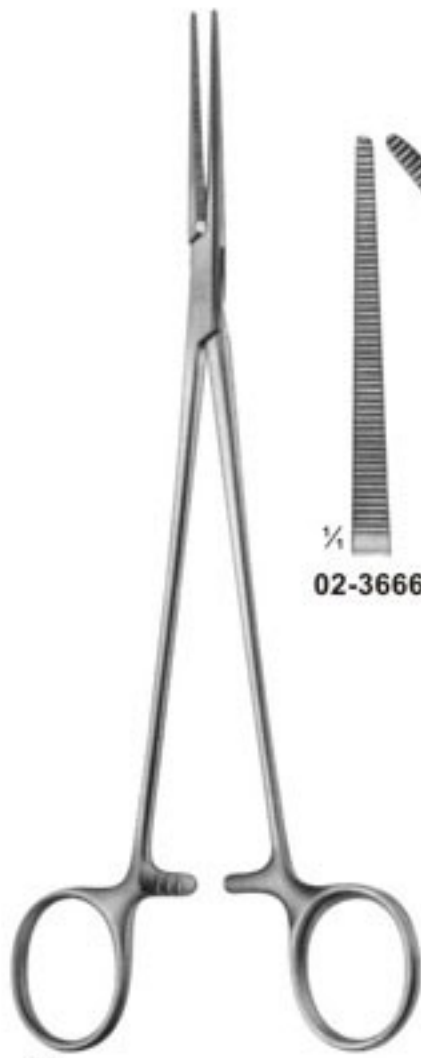

1/2
02-3666 - 02-3669
HALSTED-MOSQUITO
200 mm

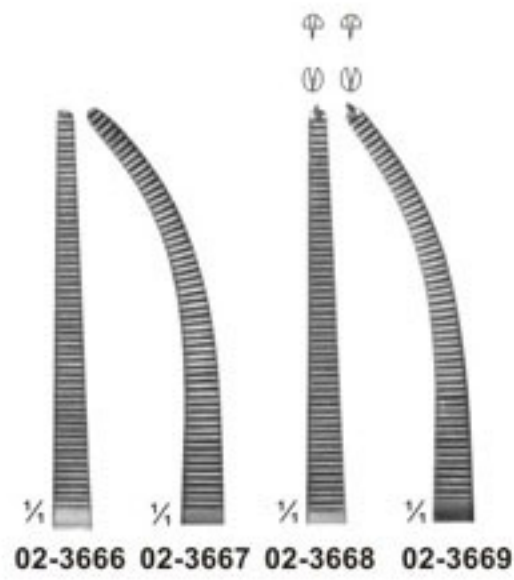

02-3670 - 02-3674
HEISS

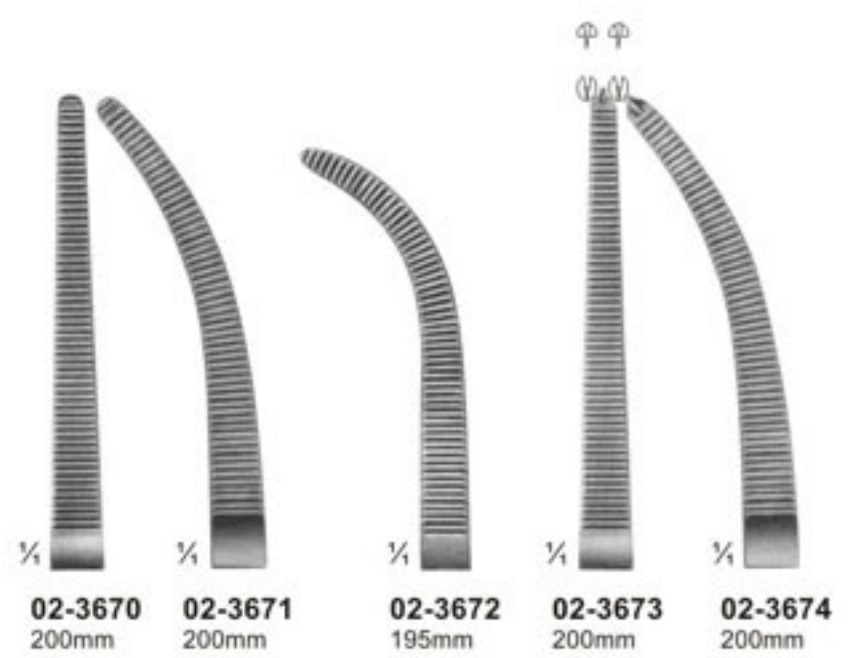

02-3675 - 02-3676
HALSTED
215 mm

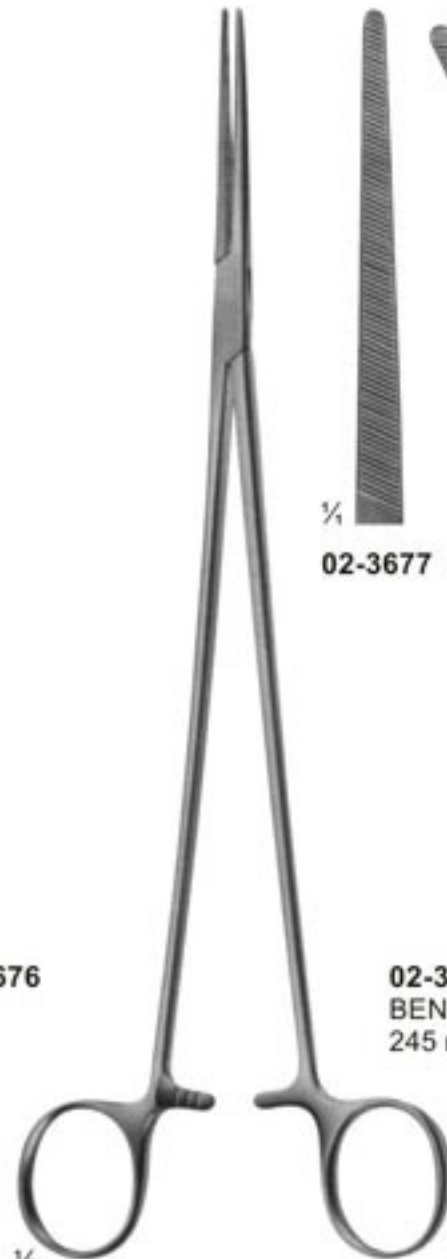

02-3677 - 02-3680
BENGOLEA
245 mm

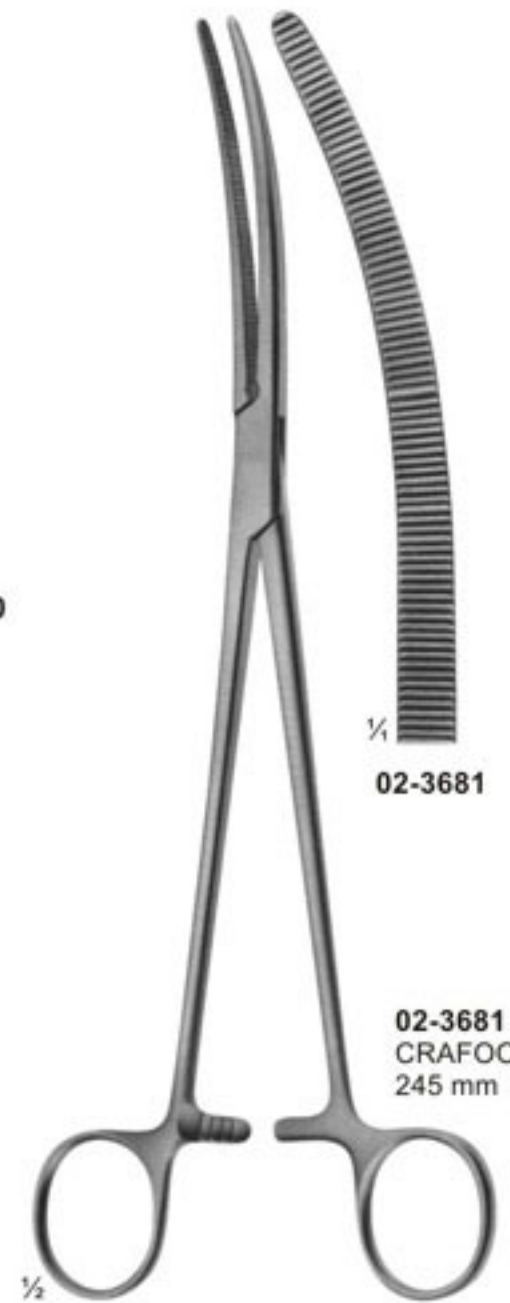
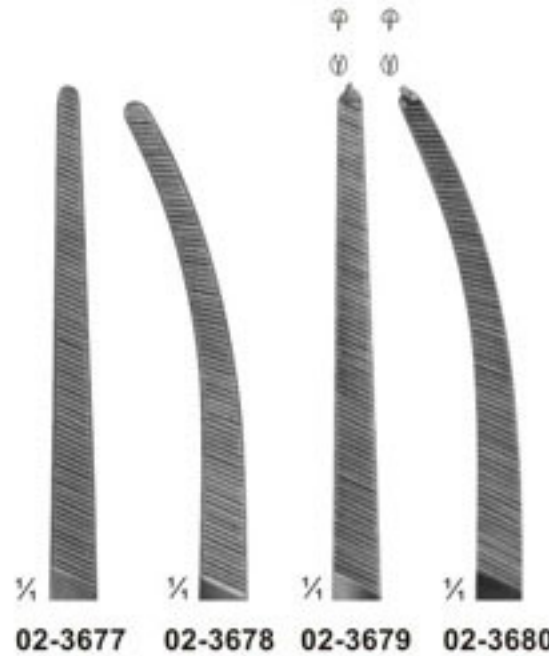

02-3681
CRAFOORD
245 mm





Haemostatic Forceps

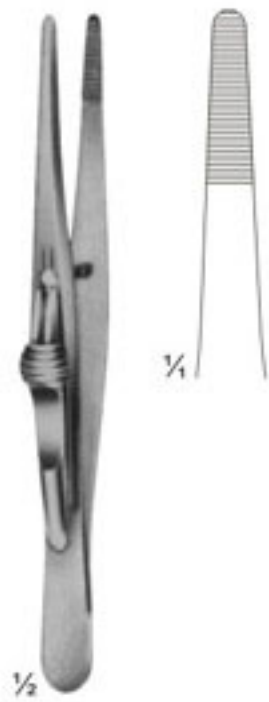

02-3682
FRICKE
Artery forceps
130 mm

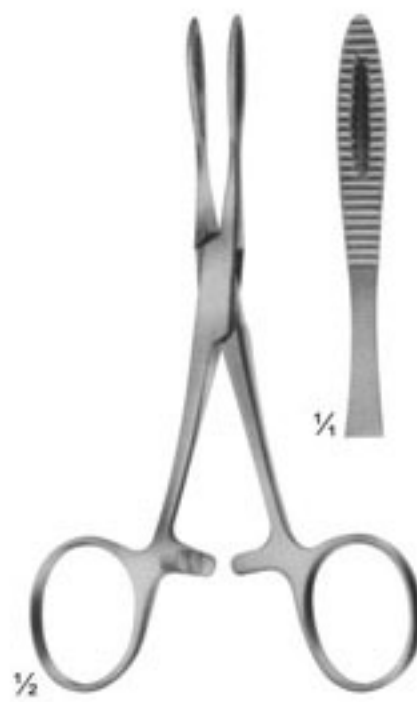

02-3683
KRONLEIN
130 mm

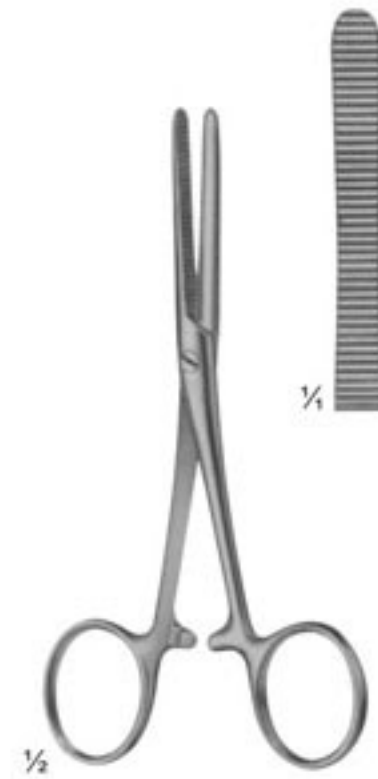

02-3684
PEAN
125 mm

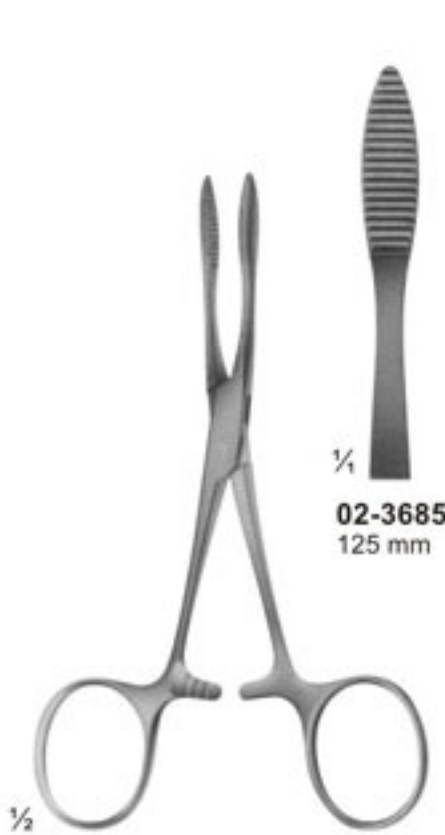

02-3685 - 02-3686
PEAN

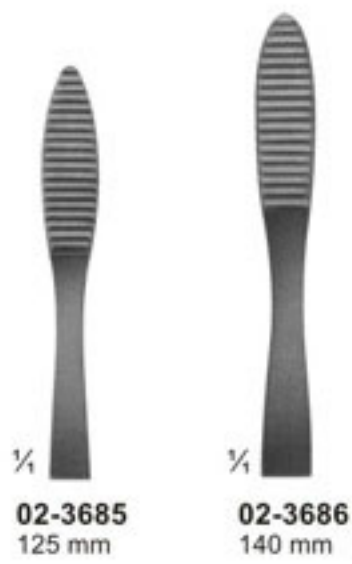

02-3685
125 mm



02-3686
140 mm

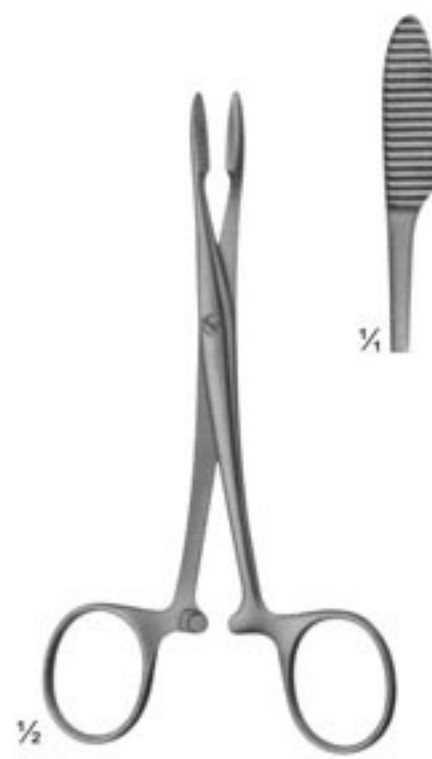

02-3687
PEAN
125mm

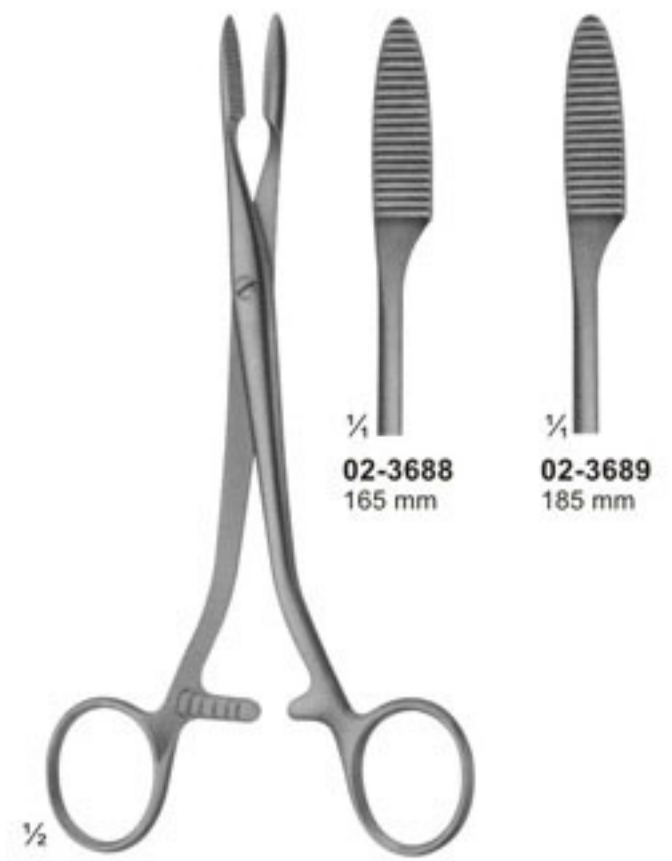

02-3688 - 02-3689
PEAN



02-3688
165 mm



02-3689
185 mm



Haemostatic Forceps

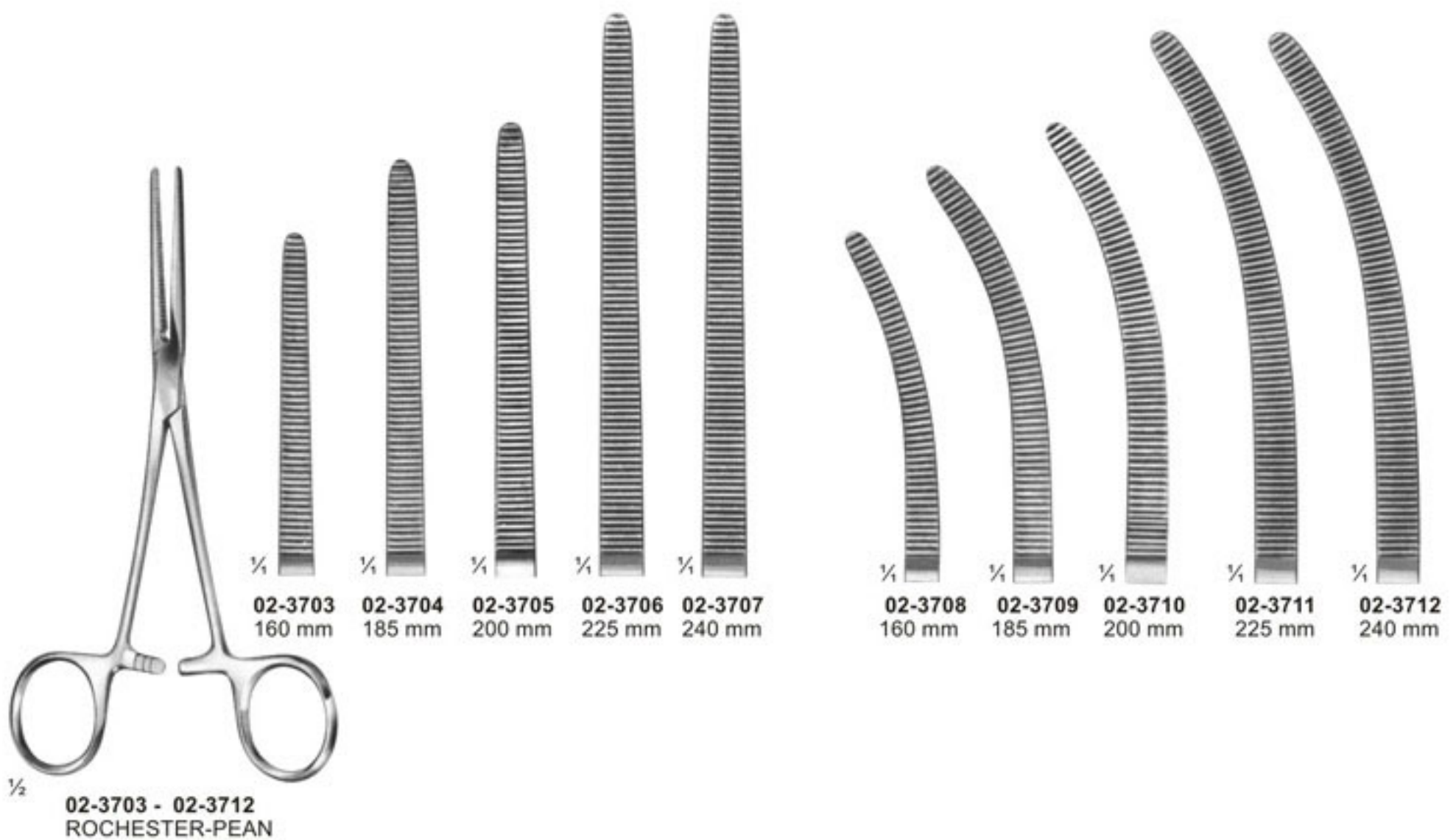
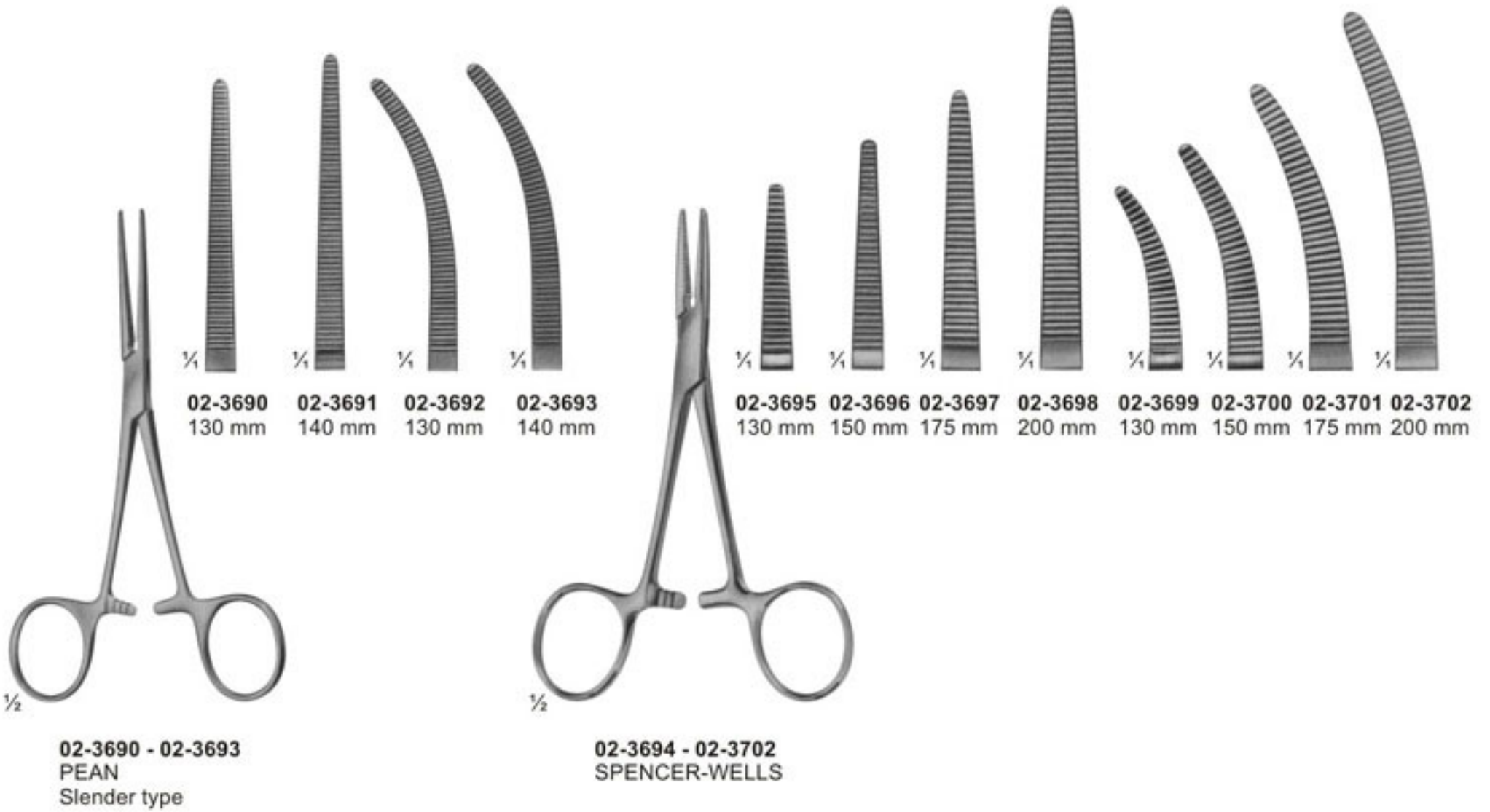



Haemostatic Forceps



02-3713 - 02-3718
PEAN

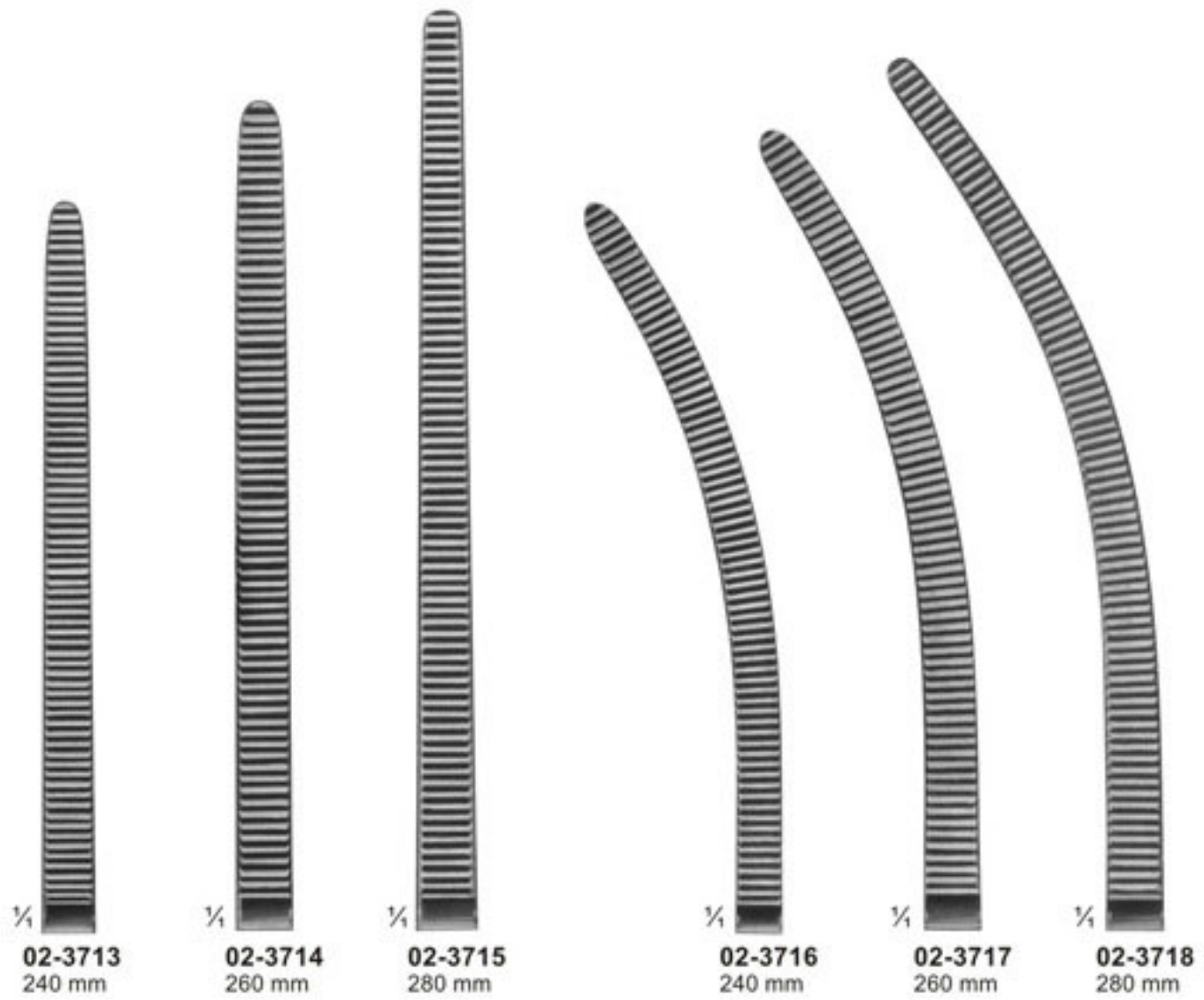

02-3713
240 mm

02-3714
260 mm

02-3715
280 mm

02-3716
240 mm

02-3717
260 mm

02-3718
280 mm

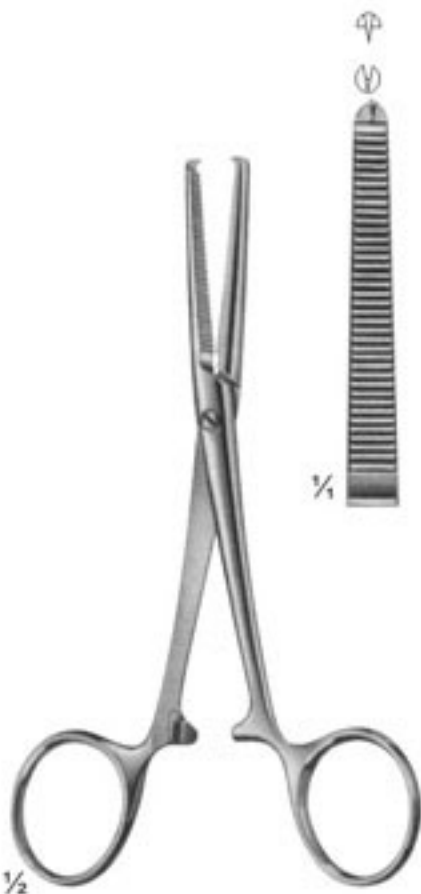

02-3719
KOCHER
Strong Pattern
145 mm

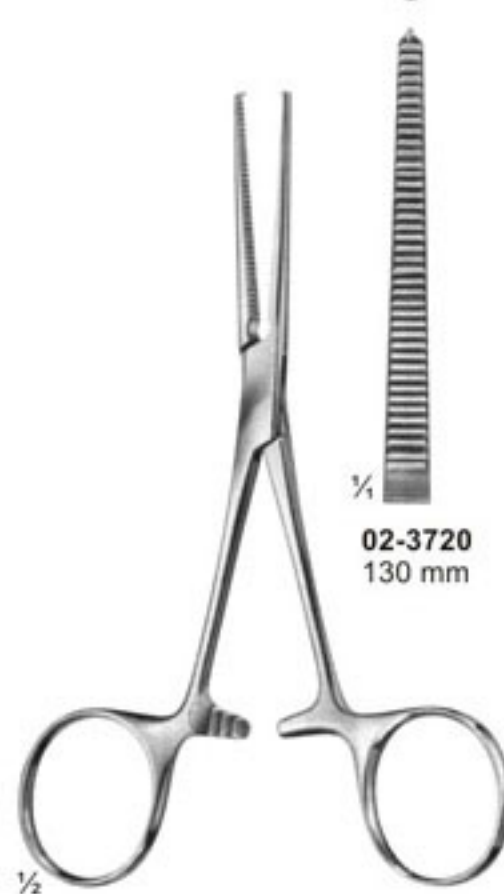

02-3720 - 02-3722
KOCHER

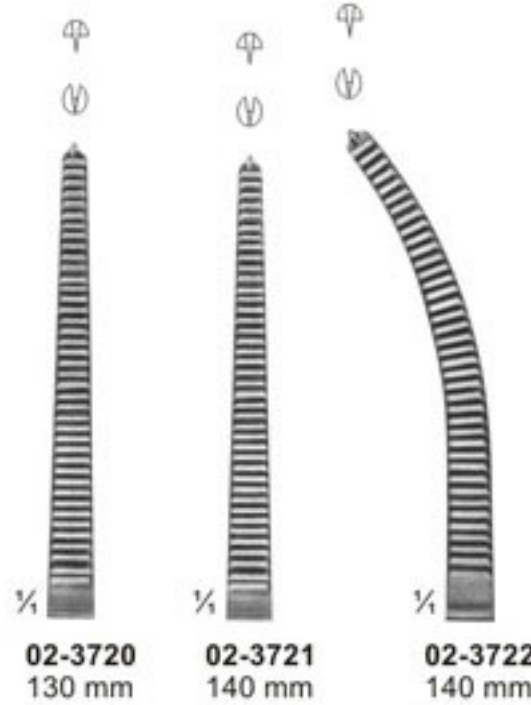

02-3720
130 mm

02-3721
140 mm

02-3722
140 mm



02-3723 - 02-3724
ROCHESTER-OCHSNER
140 mm



02-3723

02-3724



Haemostatic Forceps

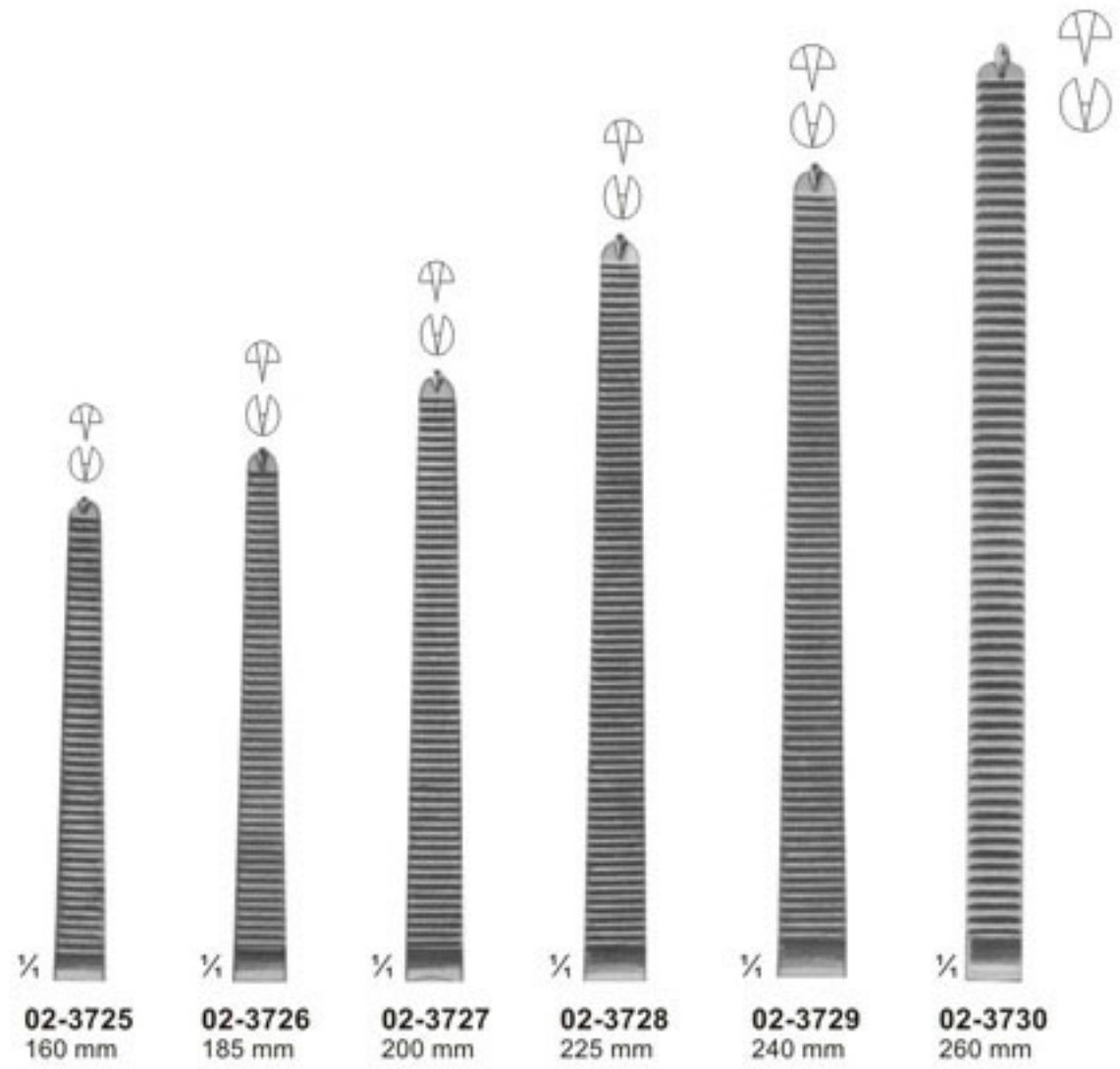

02-3725 160 mm 02-3726 185 mm 02-3727 200 mm 02-3728 225 mm 02-3729 240 mm 02-3730 260 mm



1/2

02-3725 - 02-3736
KOCHER-OCHSNER

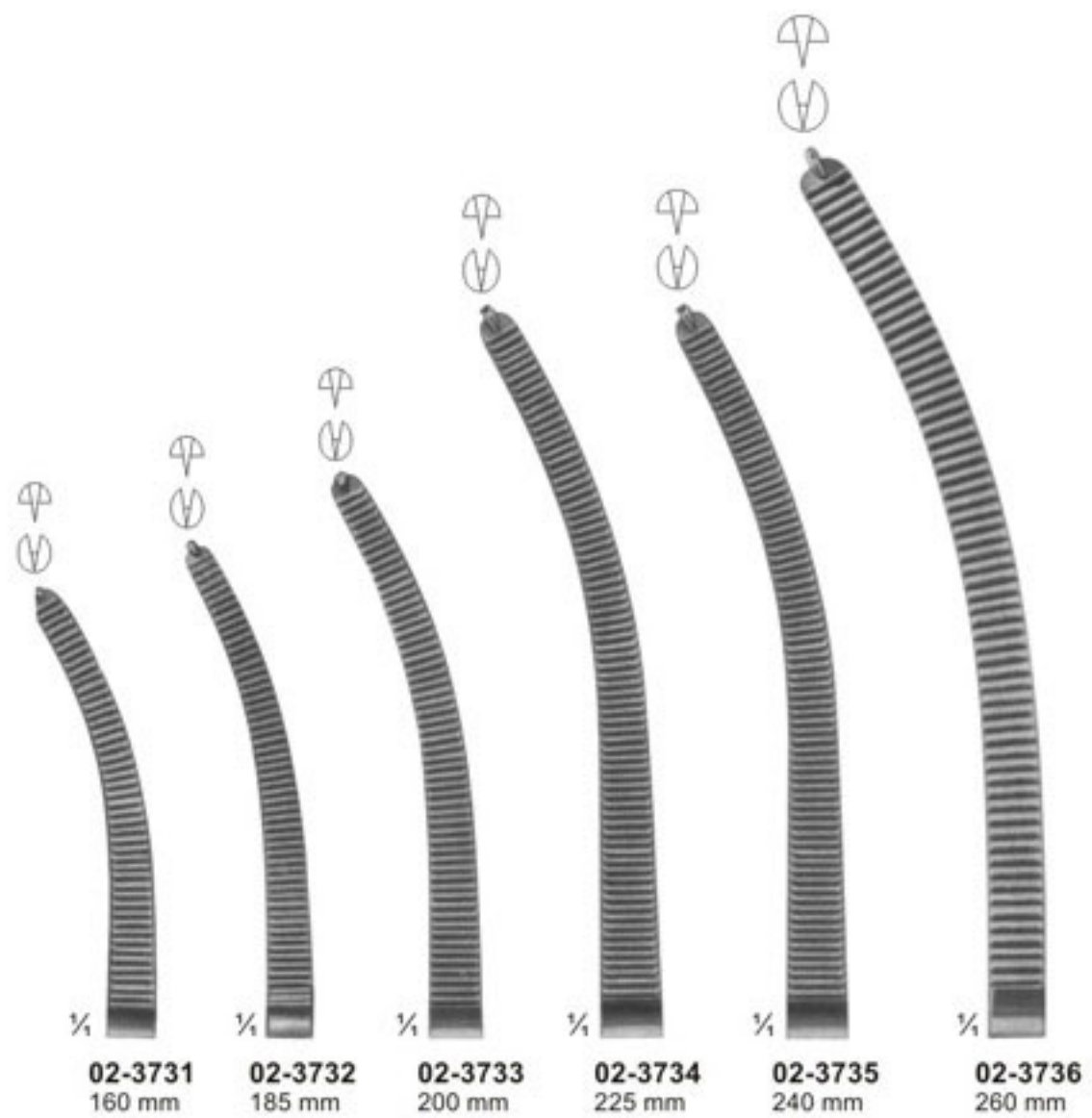

02-3731 160 mm 02-3732 185 mm 02-3733 200 mm 02-3734 225 mm 02-3735 240 mm 02-3736 260 mm



Haemostatic Forceps, Special Pattern, Tonsil Forceps



02-3737 160 mm
02-3738 200 mm
02-3739 160 mm
02-3740 200 mm

02-3737 - 02-3740
ROCHESTER-CARMALT



02-3741 230 mm
02-3742 240 mm

02-3741 - 02-3742
MOYNIHAN

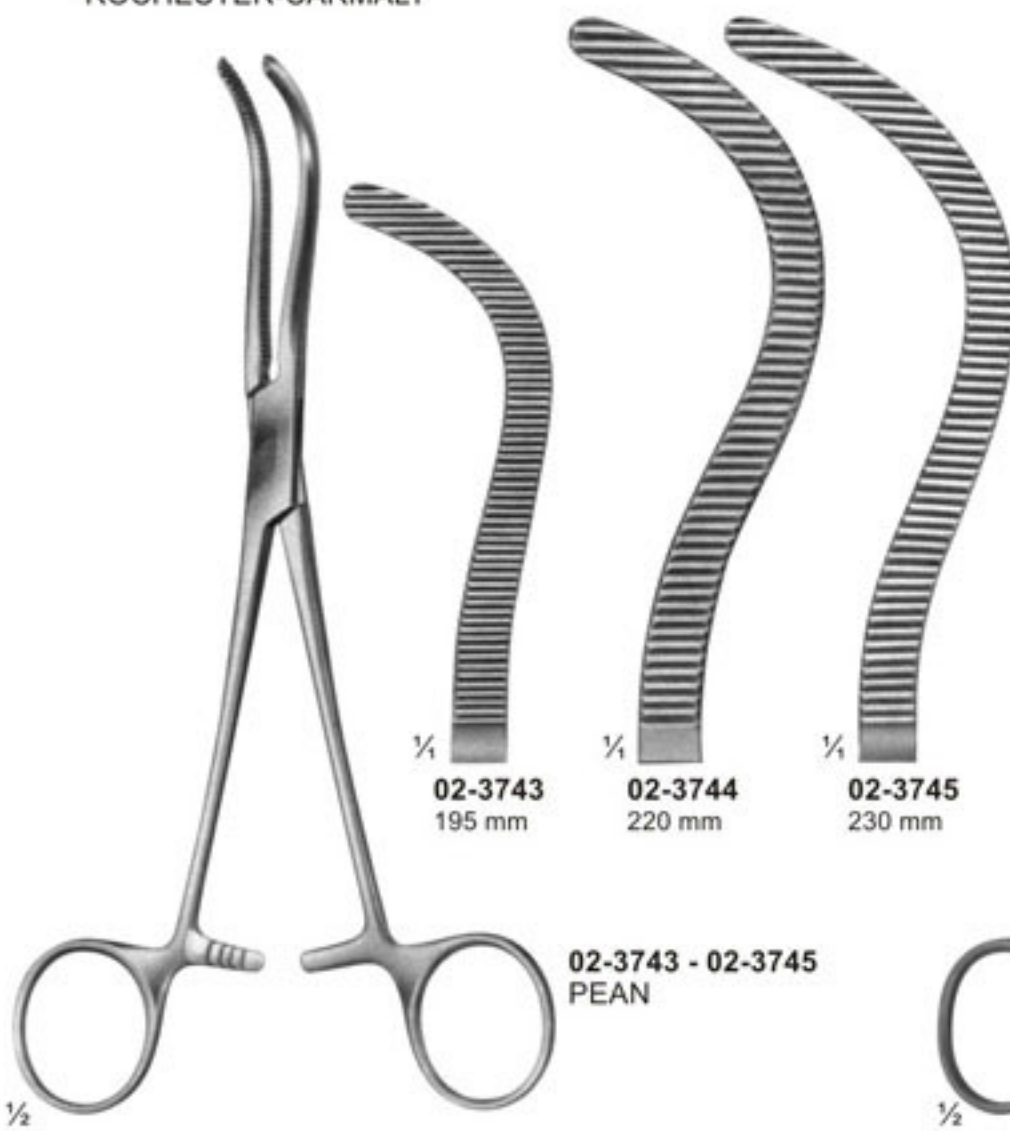

02-3743 195 mm
02-3744 220 mm
02-3745 230 mm

02-3743 - 02-3745
PEAN

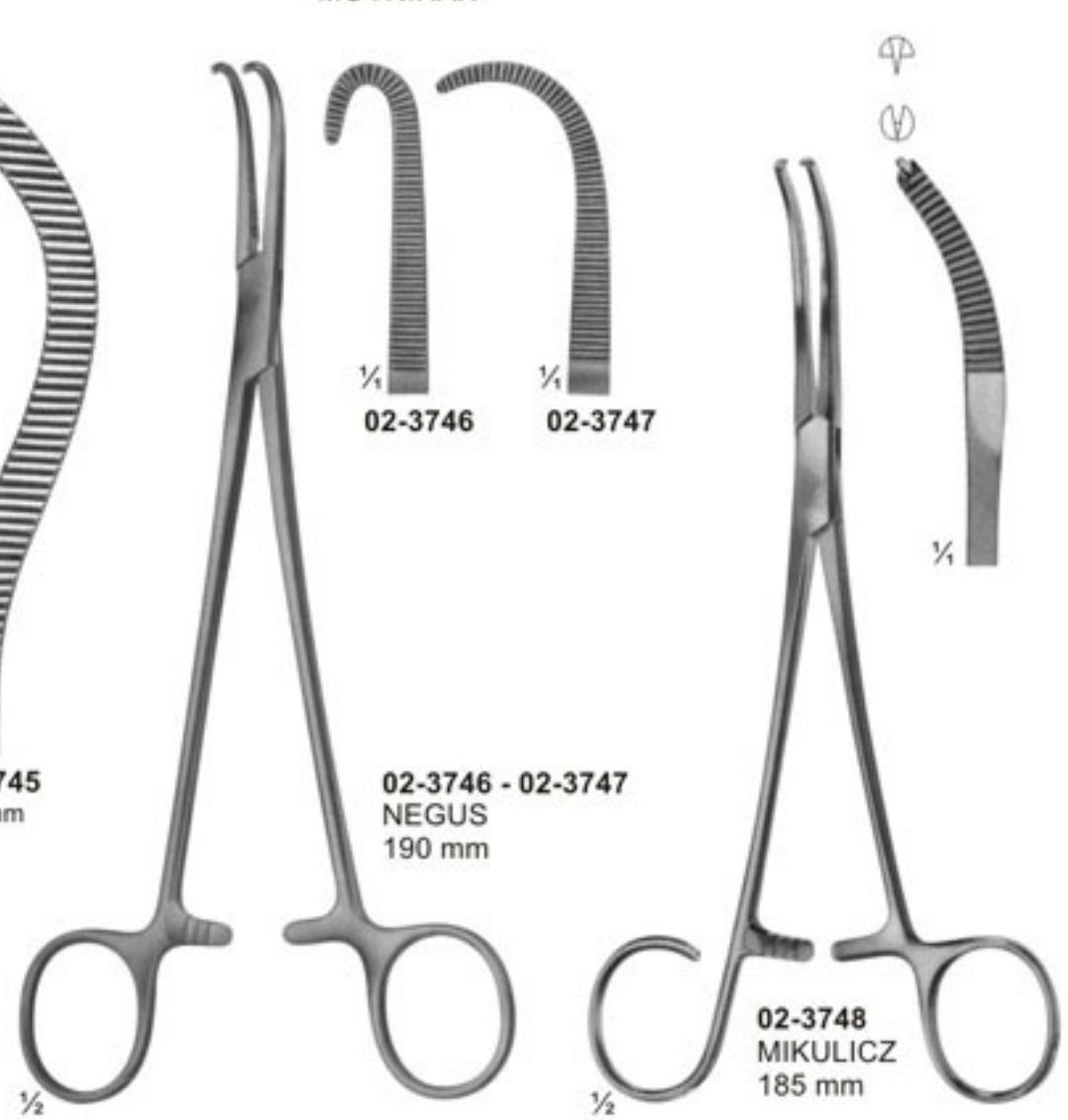

02-3746
02-3747

02-3746 - 02-3747
NEGUS
190 mm

02-3748
MIKULICZ
185 mm



Dissecting- and Ligature Forceps



02-3749
MICRO-ADSON
140 mm



02-3750
BABY-OVERHOLT
135 mm



02-3751 - 02-3752
BABY-MIXTER

02-3751
140 mm

02-3752
180 mm



02-3753 - 02-3754
BABY-ADSON

02-3753
140 mm

02-3754
180 mm



02-3755
NISSEN

02-3755
185 mm



02-3756 - 02-3757
YASARGIL
195 mm

02-3756

02-3757



02-3758
OVERHOLT-MIXTER

02-3758
205 mm



Dissecting- and Ligature Forceps



1/2

02-3759 - 02-3770
OVERHOLT-GEISSENDOERFER

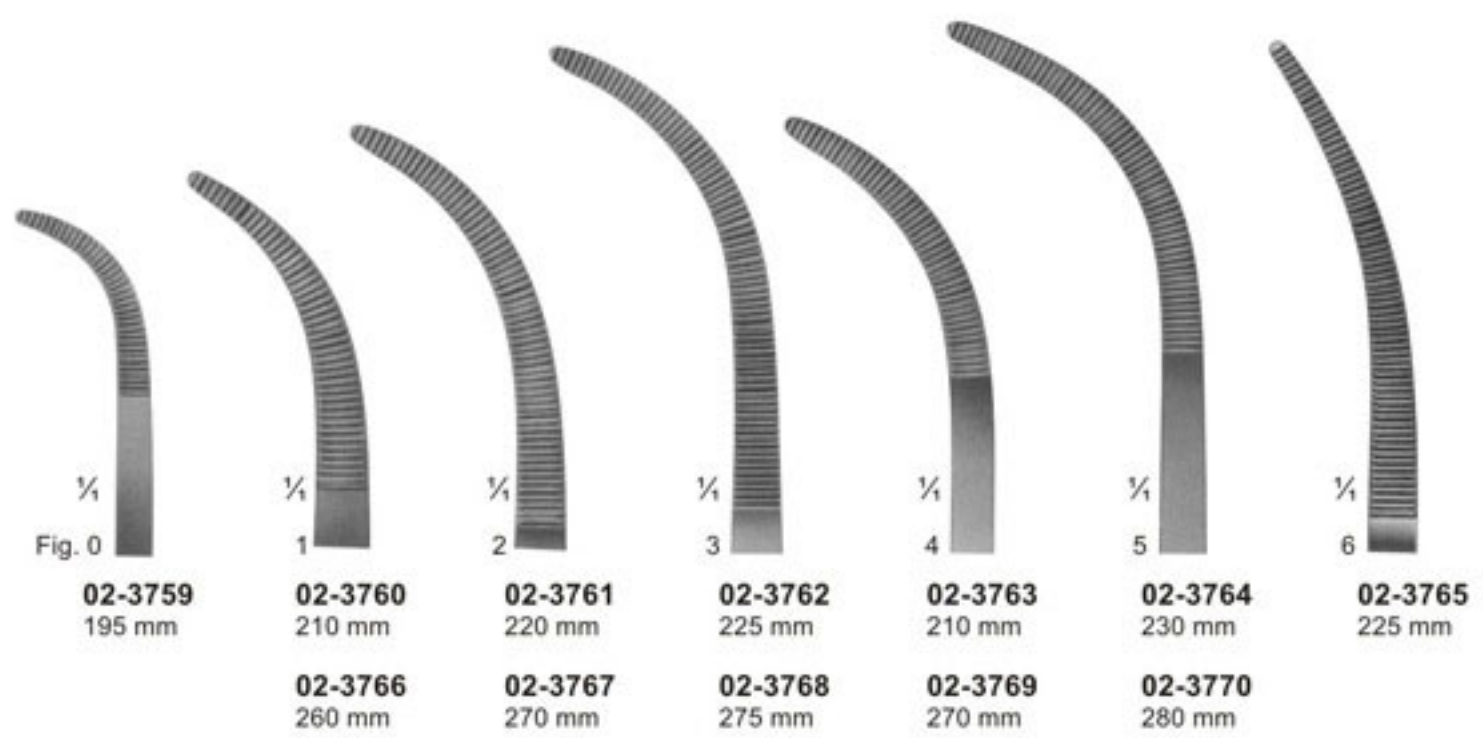

1/2

02-3771 - 02-3778
OVERHOLT
fine pattern

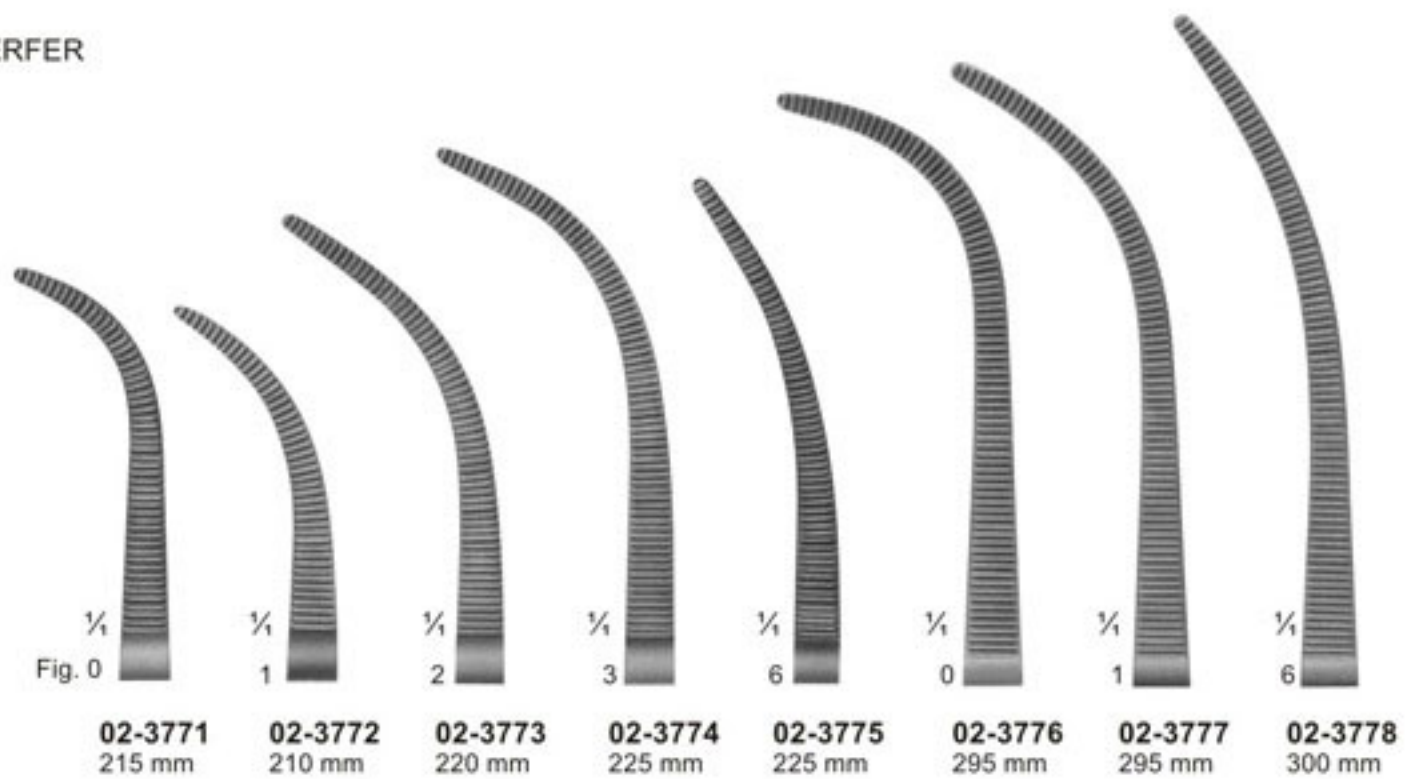



Dissecting- and Ligature Forceps



02-3779
MIXTER-O'SHAUGNESSY
190 mm



02-3780
HEISS
195 mm

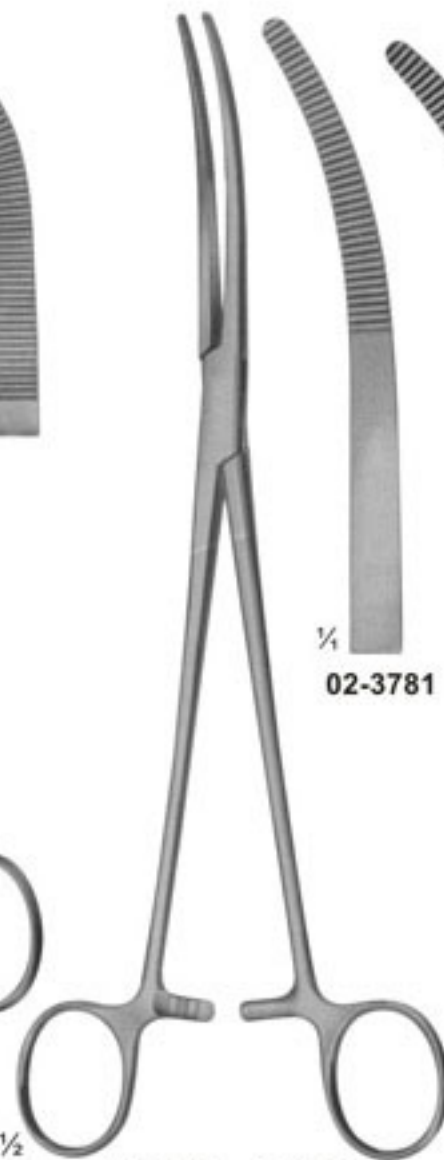

02-3781 - 02-3785
RUMEL
240 mm

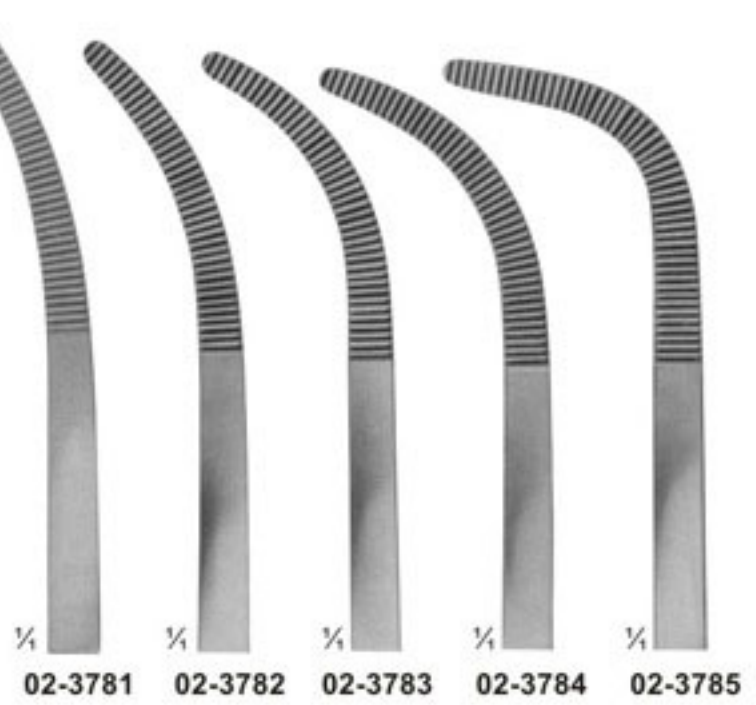

02-3781 **02-3782** **02-3783** **02-3784** **02-3785**

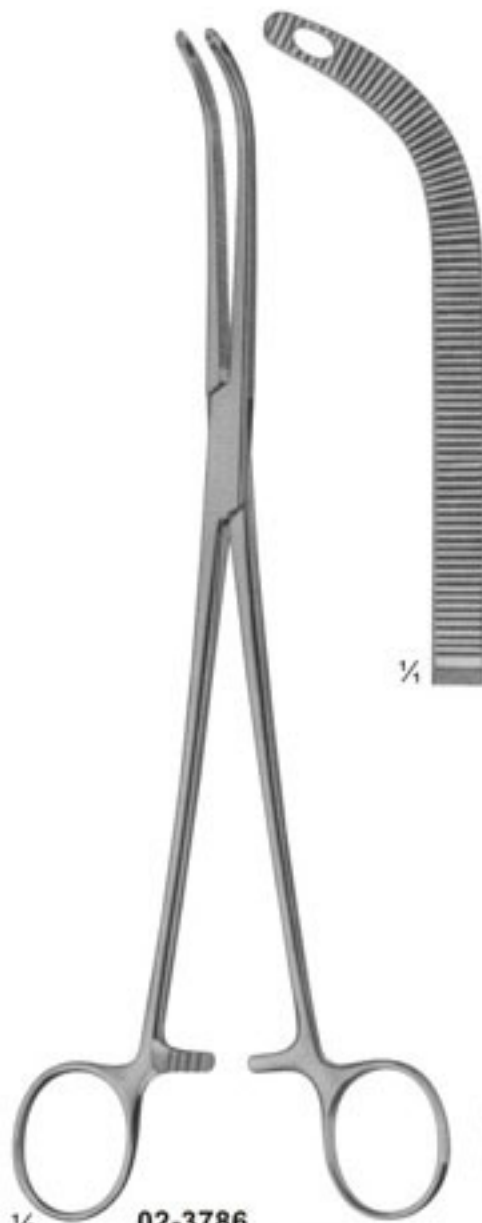

02-3786
FINOCHIETTO
245 mm



02-3787
MIXTER
230 mm



02-3788
LAWRENCE
270 mm

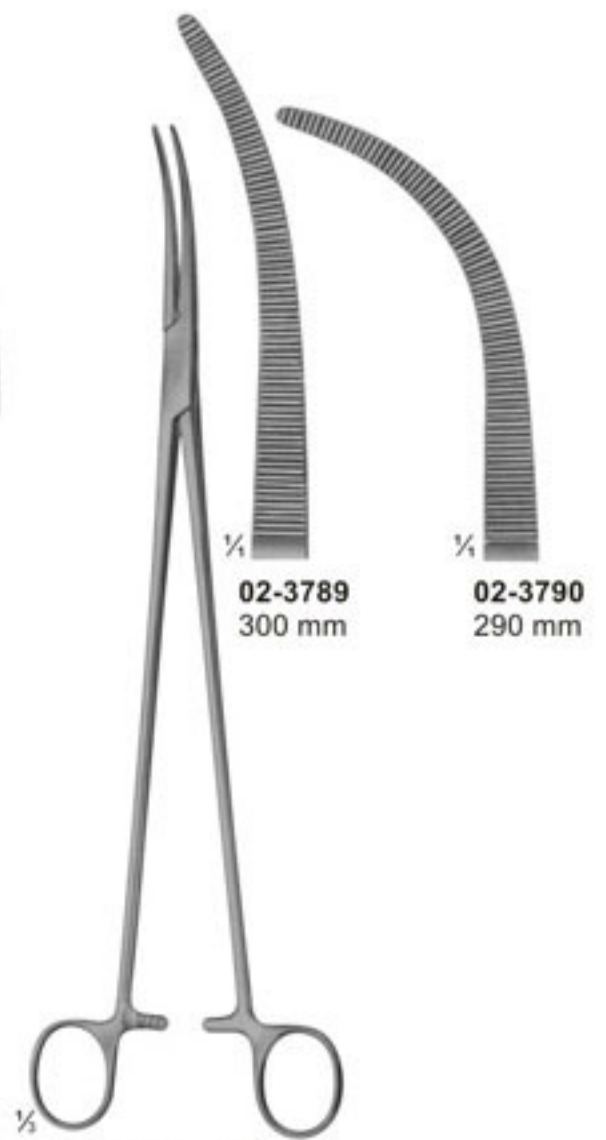

02-3789 - 02-3790
ZENKER



Dissecting- and Ligature Forceps





Peritoneum Forceps



02-3799
BABY-MIKULICZ
140 mm



02-3800
MIKULICZ
185 mm

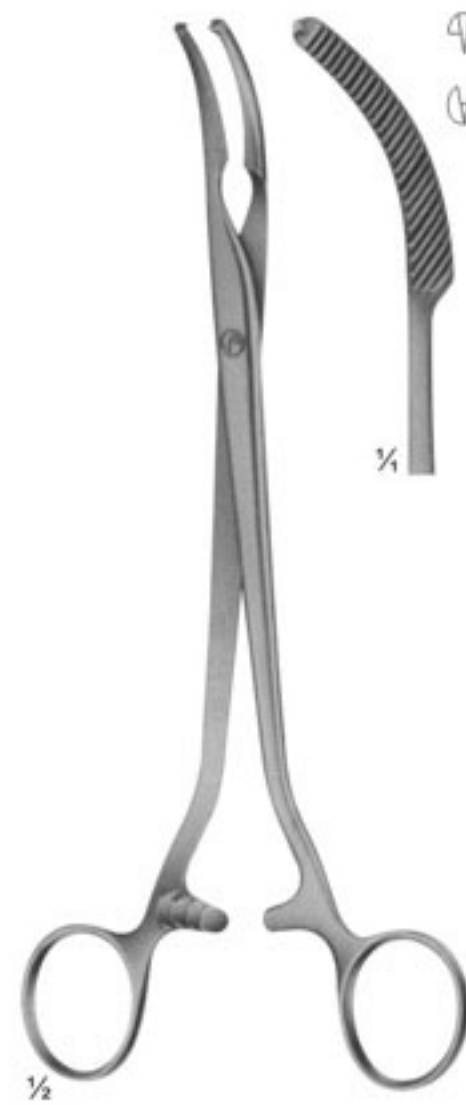

02-3801
MIKULICZ
205 mm

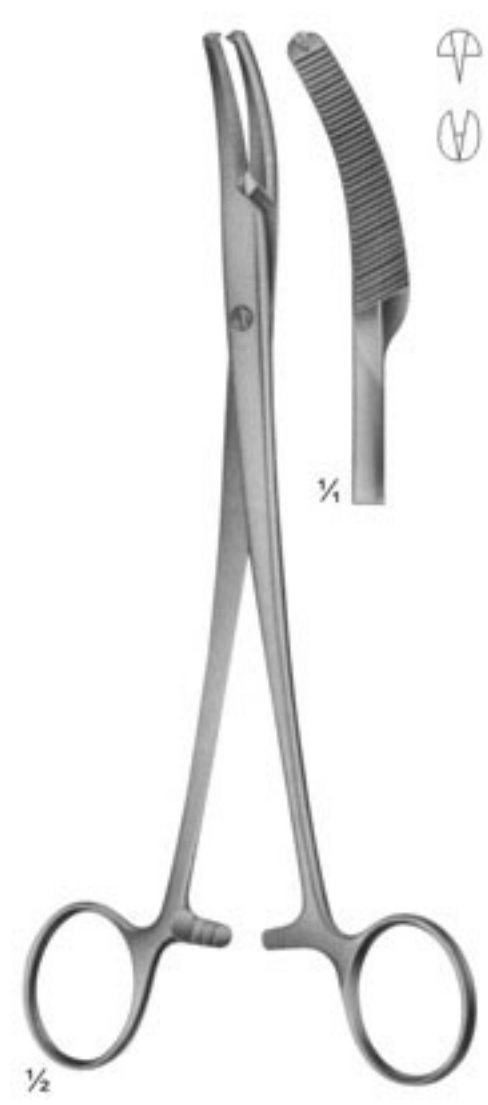

02-3802
MIKULICZ
200 mm



02-3803
MIKULICZ
205 mm

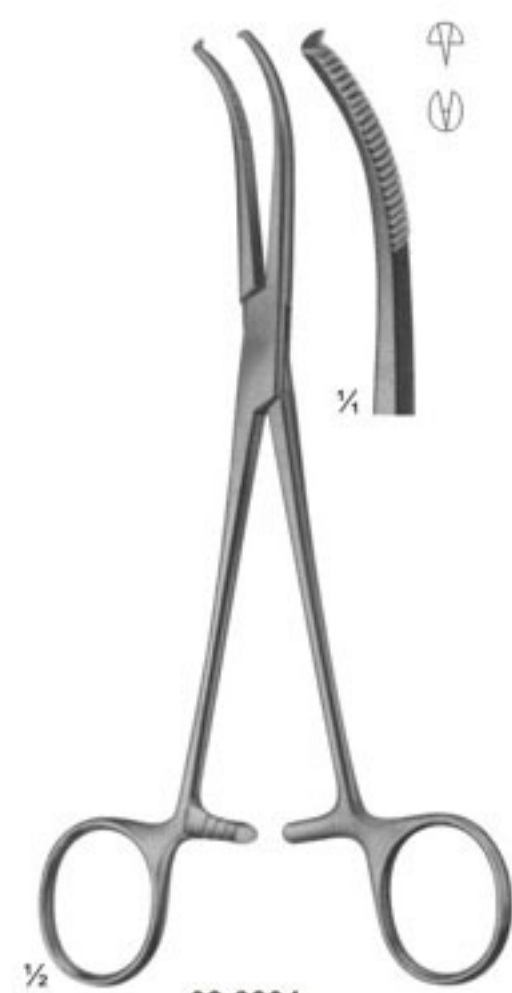

02-3804
MIKULICZ
185 mm

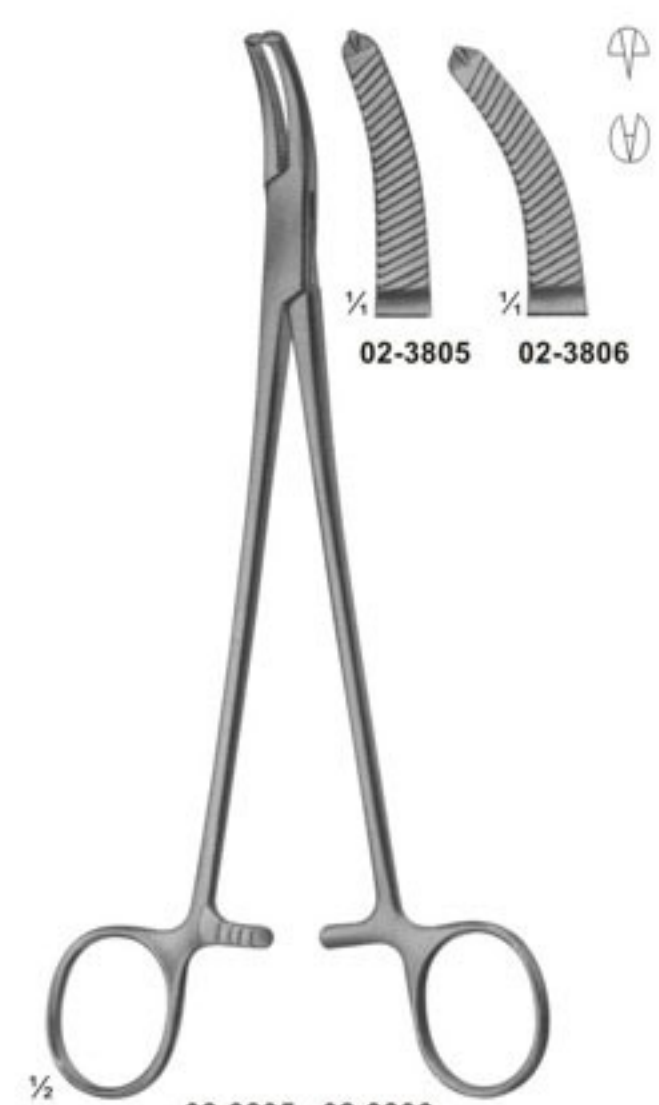

02-3805 - 02-3806
FAURE
205 mm



Hysterectomy and Haemostatic Forceps



02-3807 - 02-3808
PHANEUF

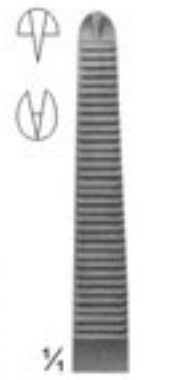

02-3807
210 mm



02-3808
205 mm



02-3809 - 02-3810
HEANEY modif.



02-3809
205 mm



02-3810
245 mm

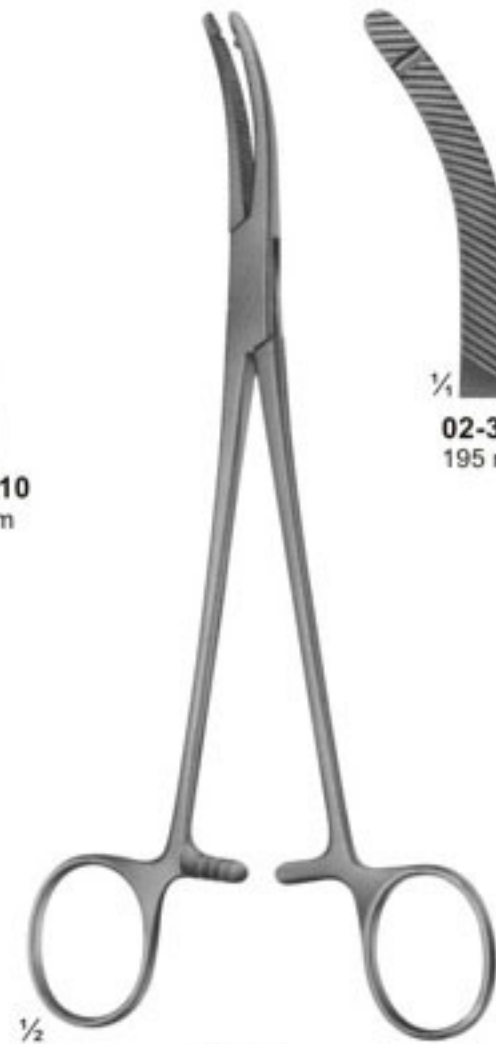

02-3811
HEANEY



02-3811
195 mm



02-3812
WERTHEIM



02-3812
235 mm

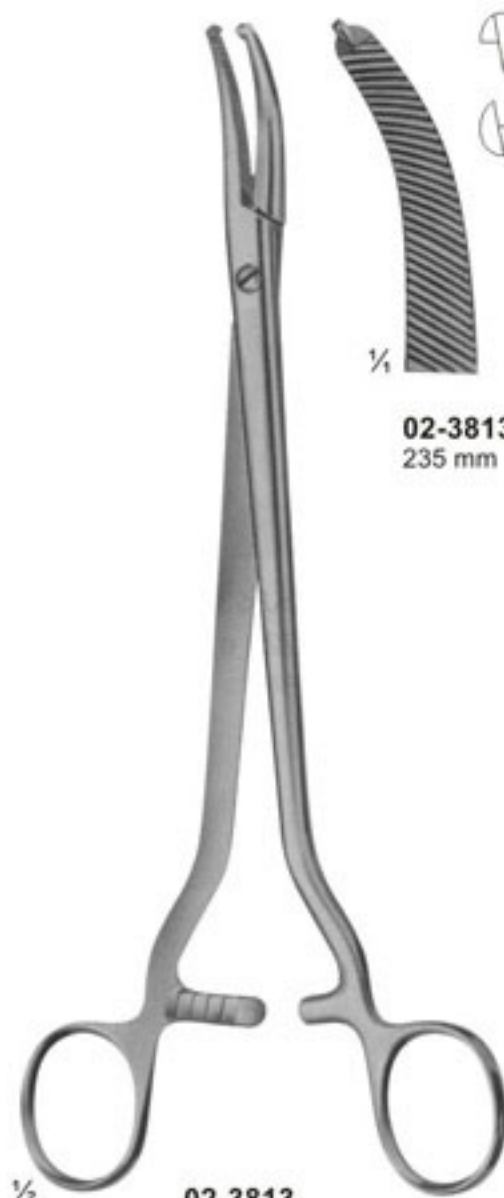

02-3813
WERTHEIM



02-3813
235 mm



02-3814
WERTHEIM



02-3814
245 mm



Atraumata Hysterectomy Forceps and Vaginal Clamps ATRAUMATA



02-3815
225 mm



02-3816
220 mm



02-3817
215 mm



02-3818
205 mm



02-3819
250 mm



02-3820
245 mm



02-3821
240 mm

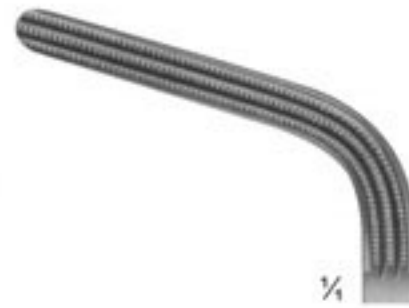

02-3822
220 mm



Hysterectomy Forceps and Vaginal Clamps and Compression Forceps ATRAUMATA



02-3823
WERTHEIM
Hysterectomy Forceps
255 mm

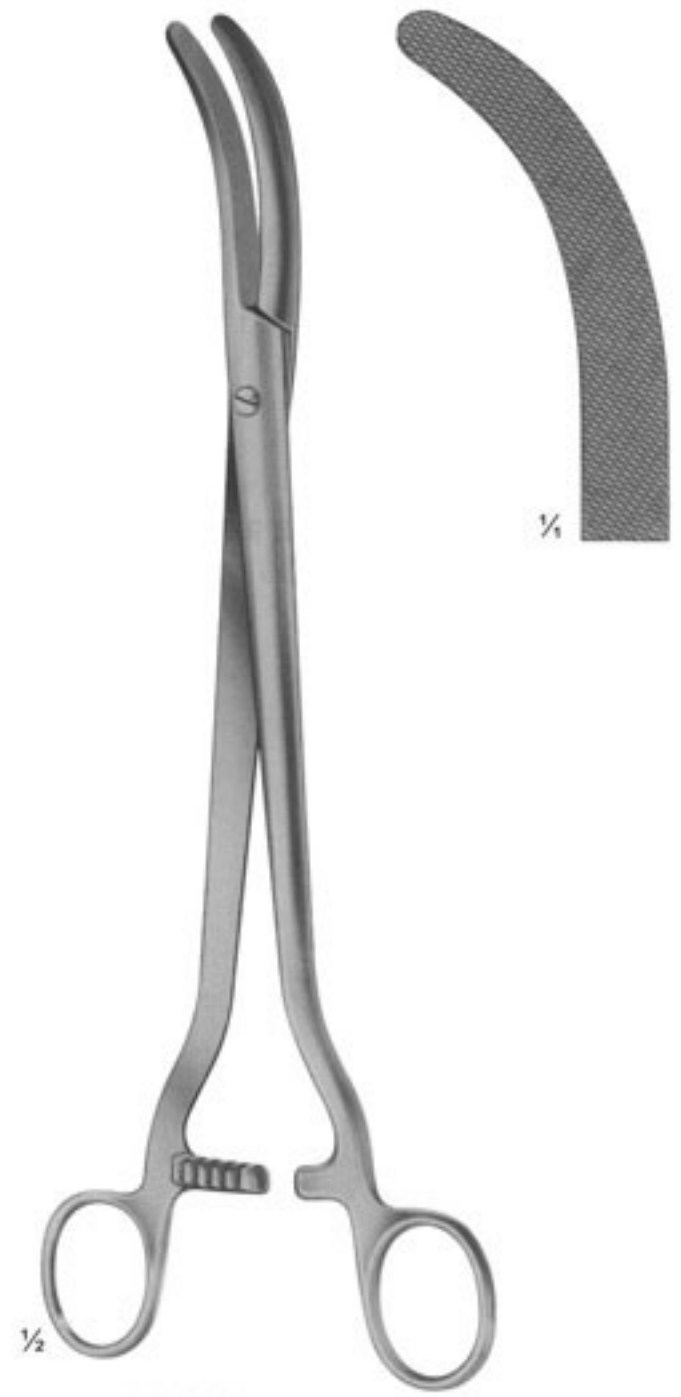

02-3824
WERTHEIM
Parametrium Clamp
260 mm



02-3825 - 02-3827
DICK



02-3825 255 mm 02-3826 265 mm 02-3827 275 mm



Clamps and Compression Forceps

ATRAUMATA



02-3828
WERTHEIM
250 mm



1/4

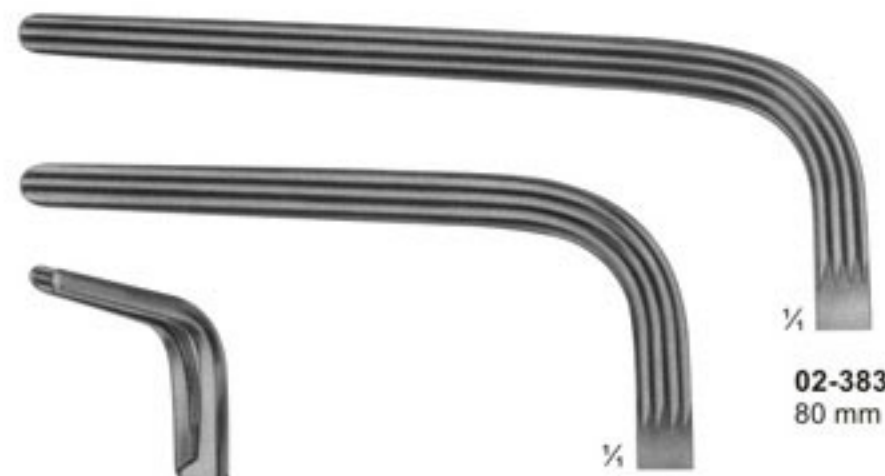

02-3831
80 mm

1/4

02-3830
60 mm



1/2 02-3829
WERTHEIM-CULLEN
215 mm



1/2 02-3830 - 02-3831
230 mm