



# Gall Duct Forceps



**03-5622**  
LOWER  
180 mm



**03-5623**  
LAHEY ( SWEET )  
190 mm



**03-5624**  
LAHEY  
220 mm



**03-5625**  
DESJARDINS  
Gall duct-and cystic forceps  
210 mm



**03-5626**  
NISSEN  
Gall duct-and cystic forceps  
215 mm



# Gall Duct Forceps and Choledochus Forceps

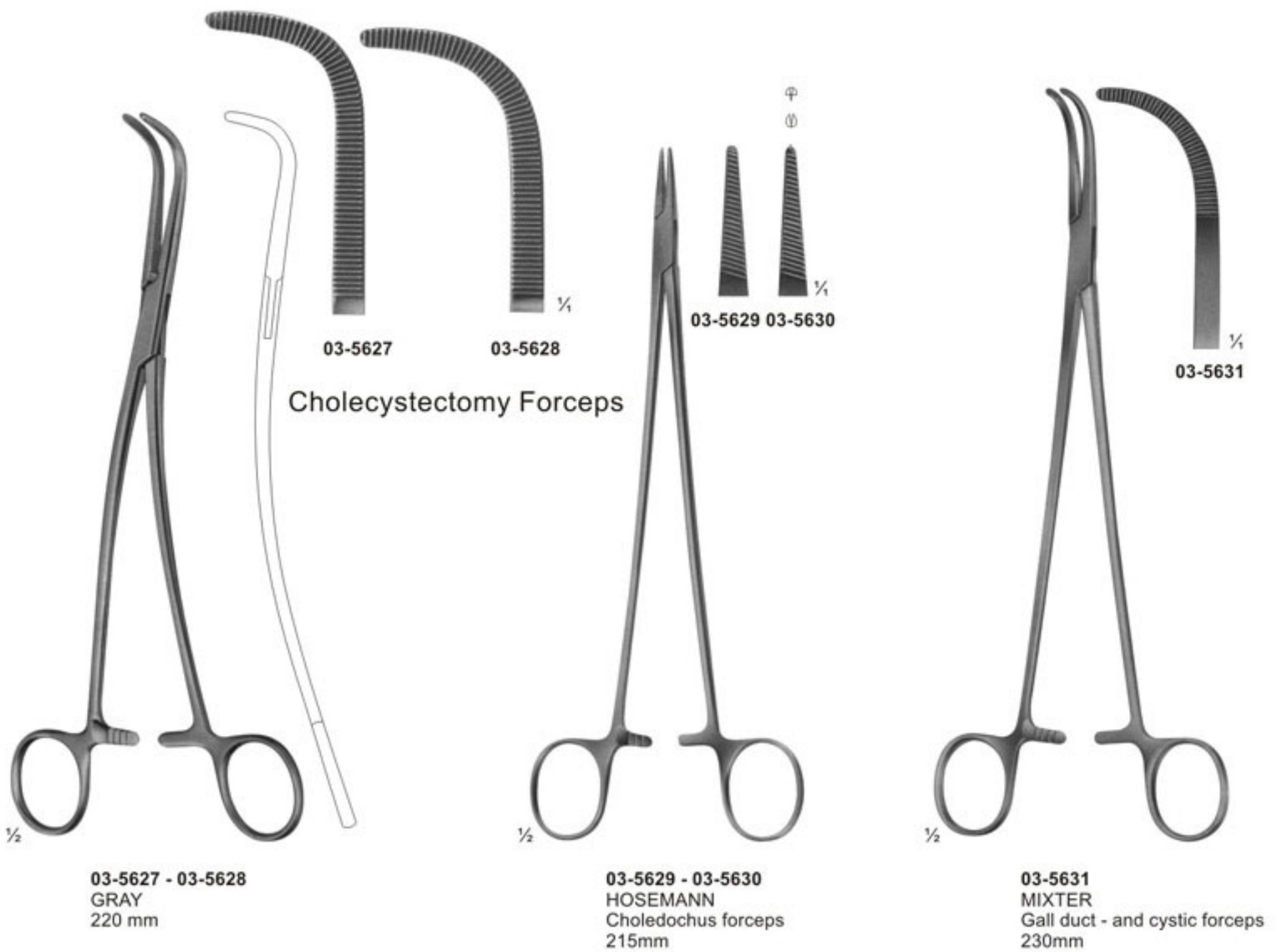





# Gall Bladder Forceps and Gall Duct Scissors

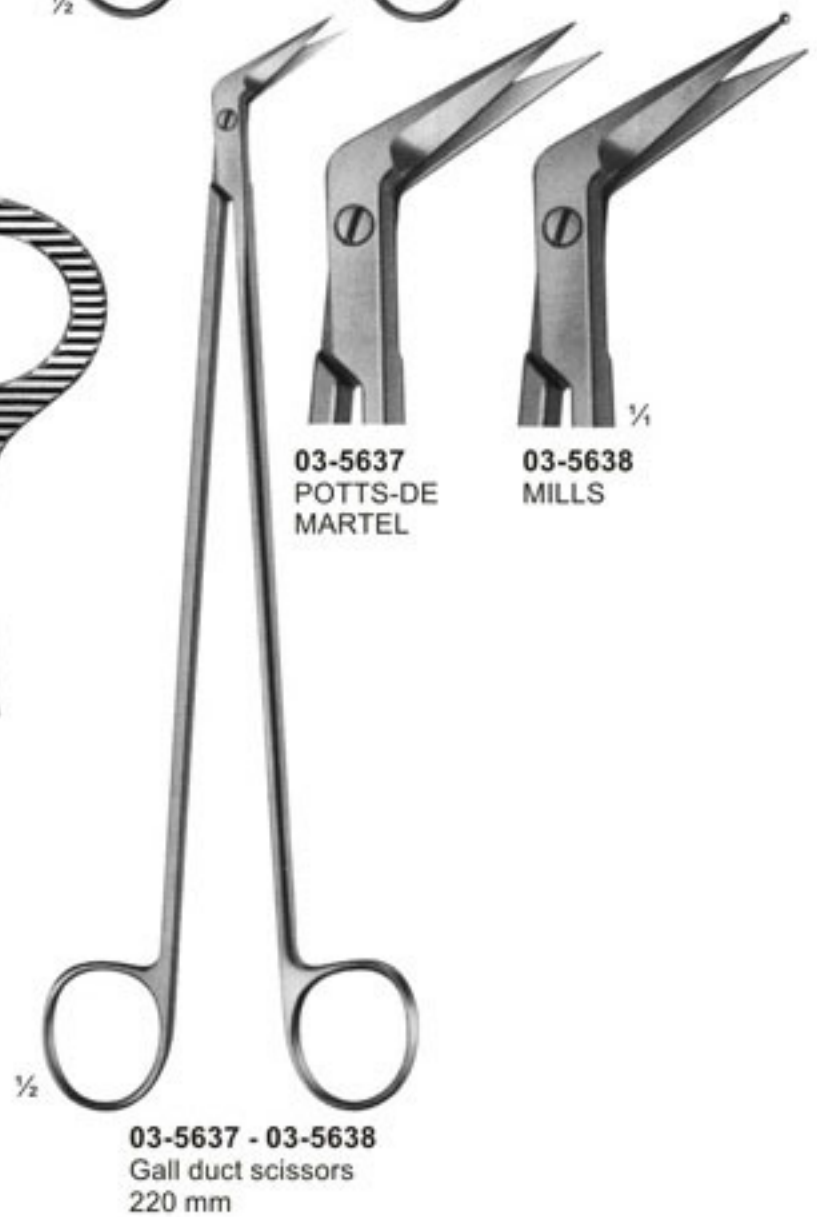
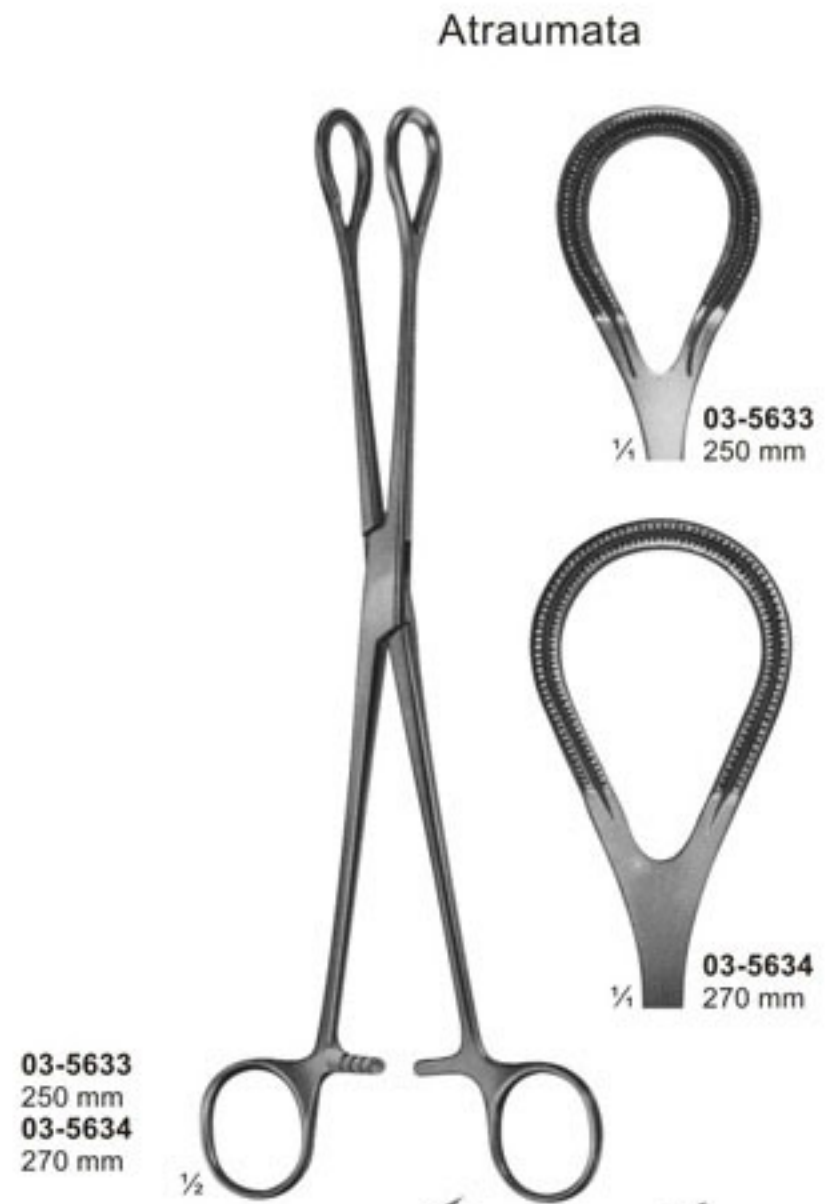
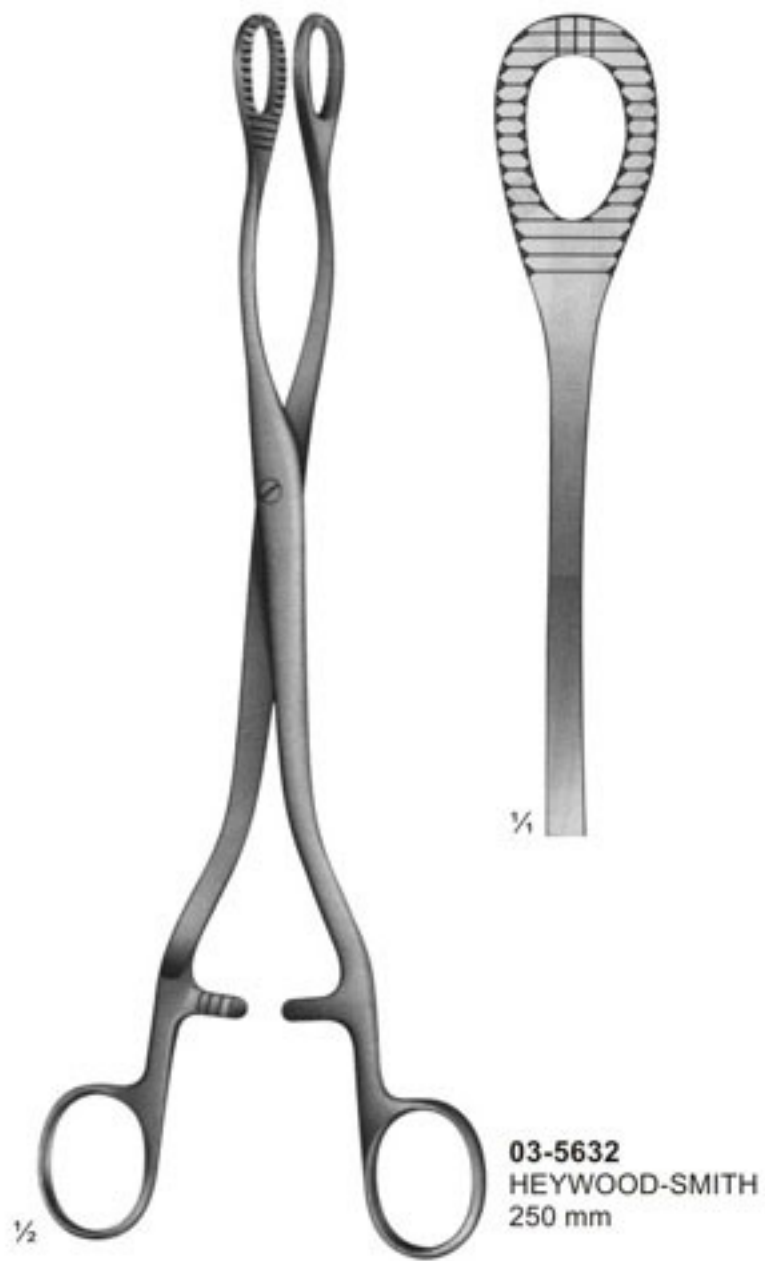



# Gall Duct Probes

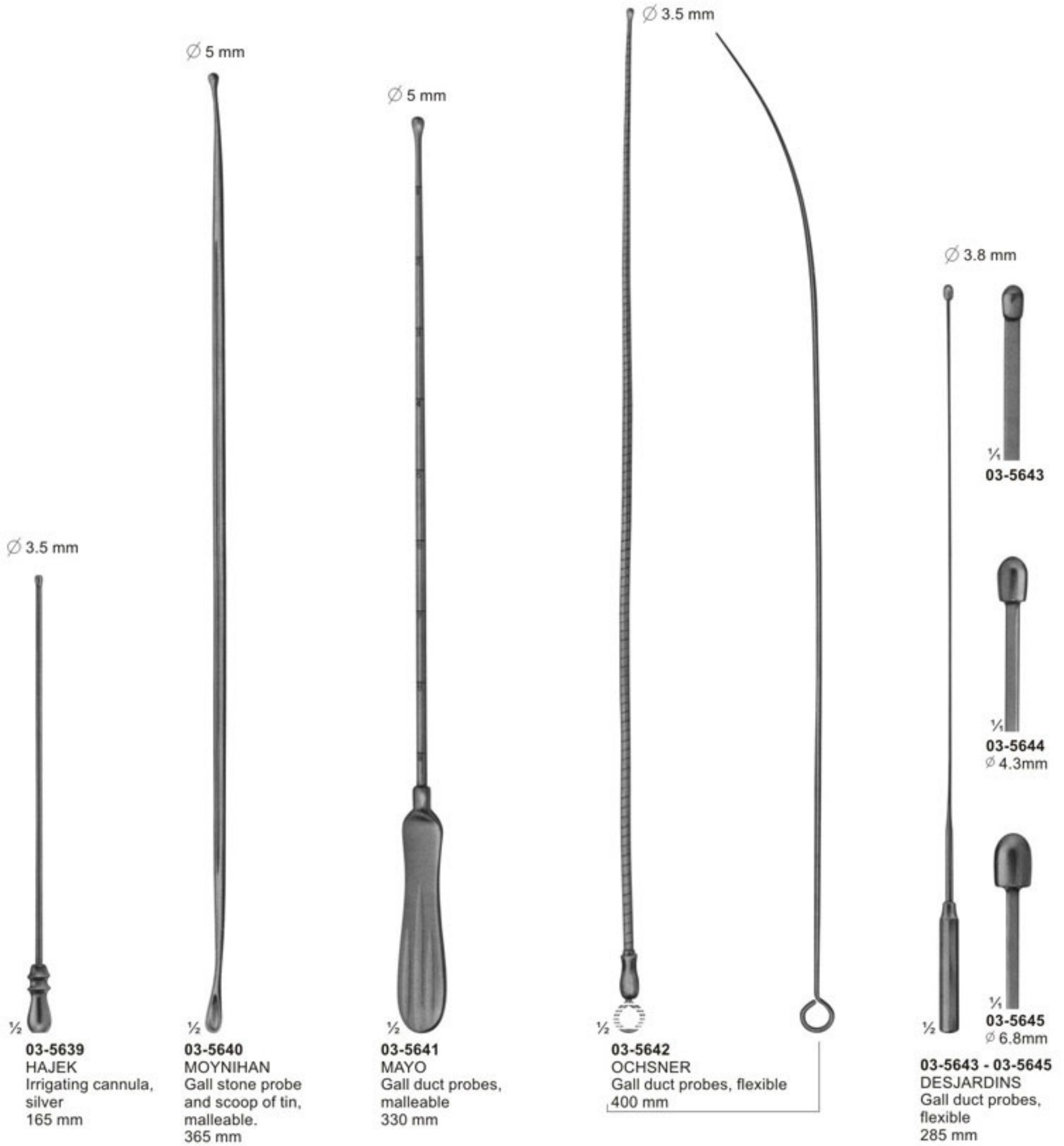





# Gall Duct Dilators & Gall Stone Scoops

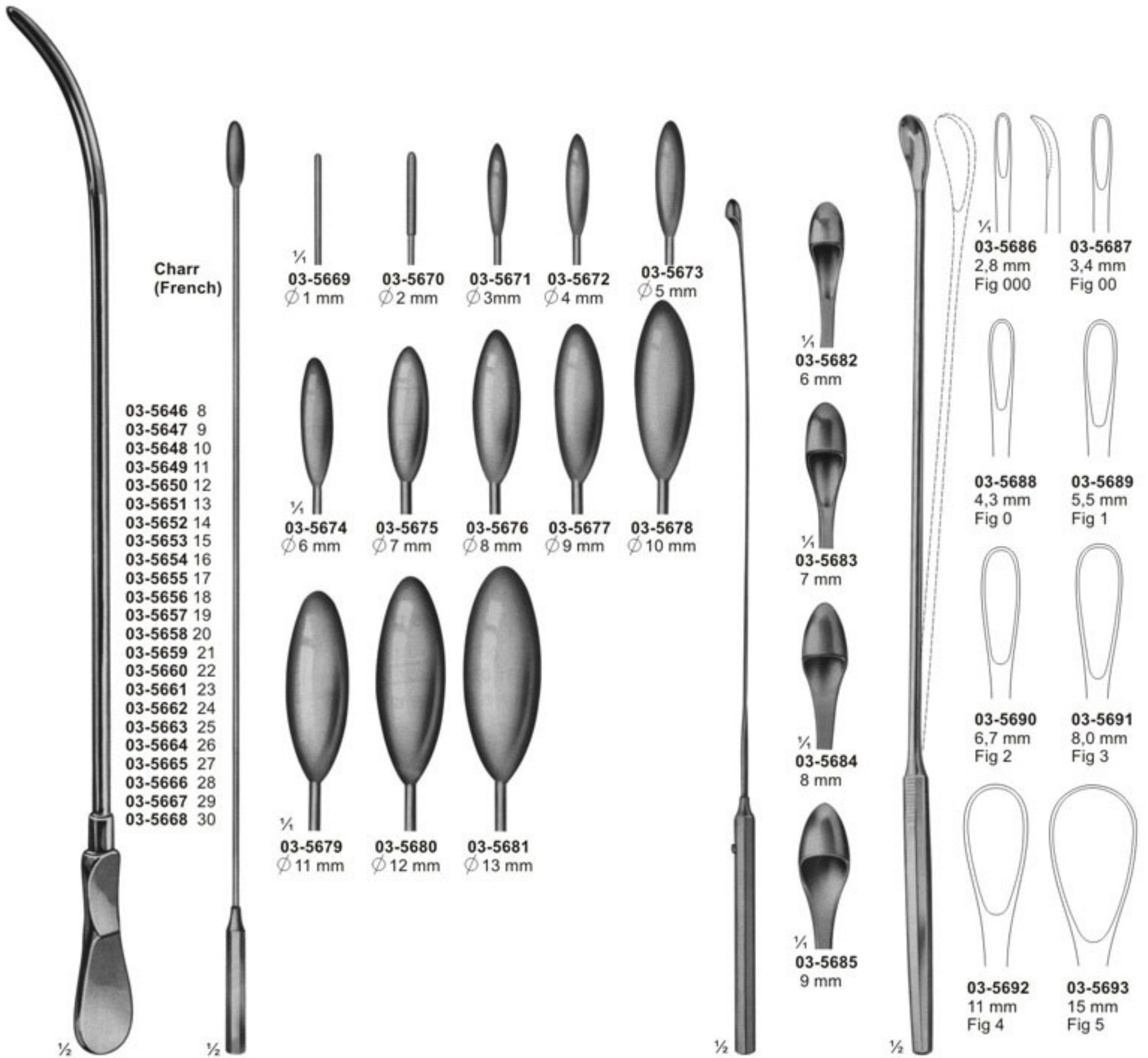

**03-5646 - 03-5668**  
DITTEL  
Metal bougies and dilating sounds, stiff 345 mm

**03-5669 - 03-5681**  
BAKES  
Common bile duct dilators, malleable  
03-5669-03-5673 315mm  
03-5674-03-5681 320mm  
Set of 9 pieces (03-5671-03-5679) in canvas roll

**03-5682 - 03-5685**  
DESJARDINS  
Probes and catch with flexible shaft 300 mm

**03-5686 - 03-5693**  
LUER-KOERTE  
modif with malleable shaft 310 mm





# Gall Stone Forceps

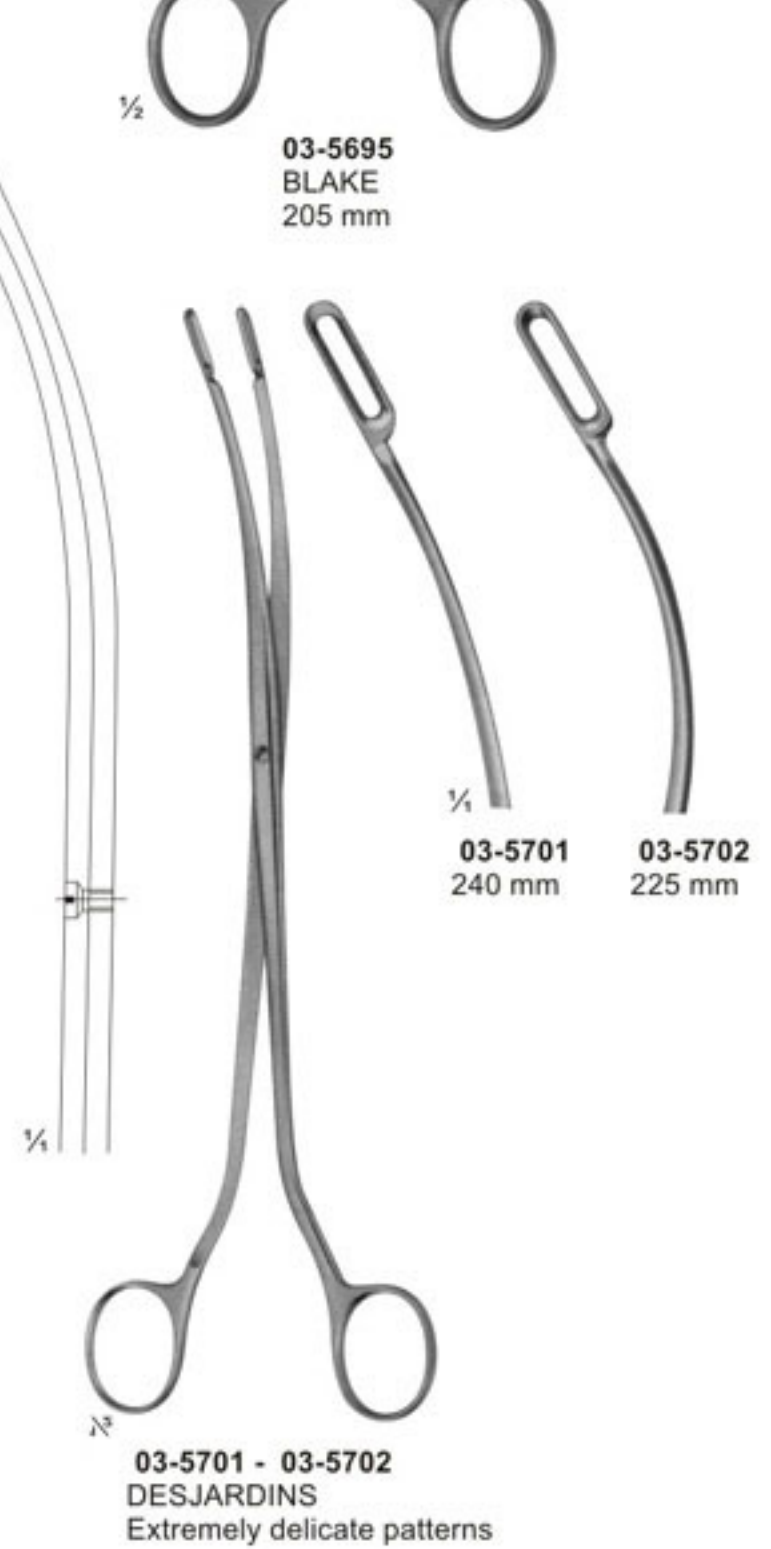
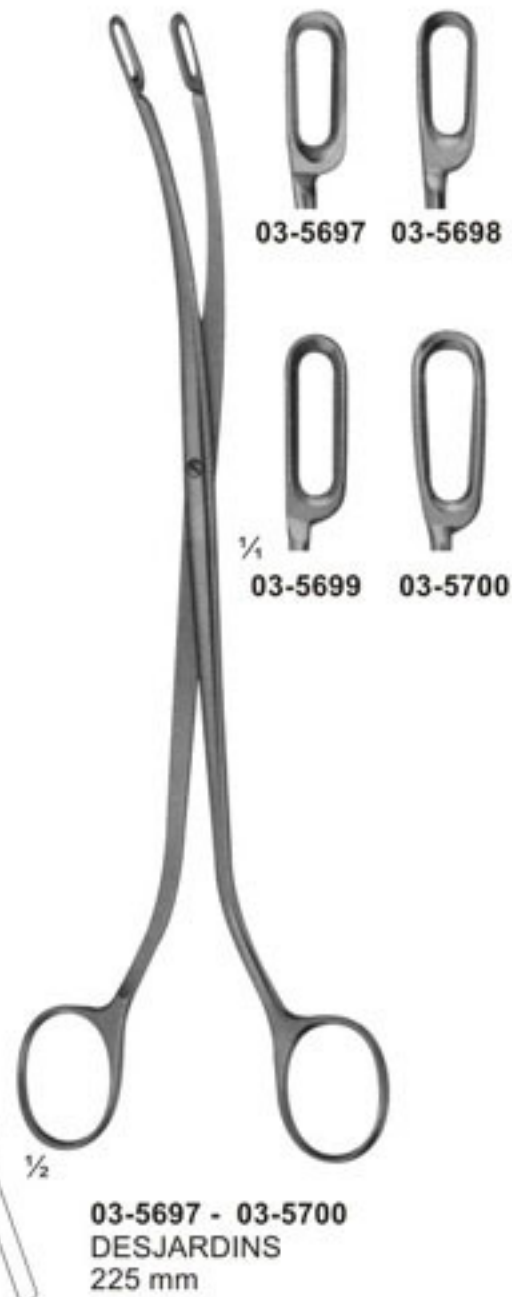
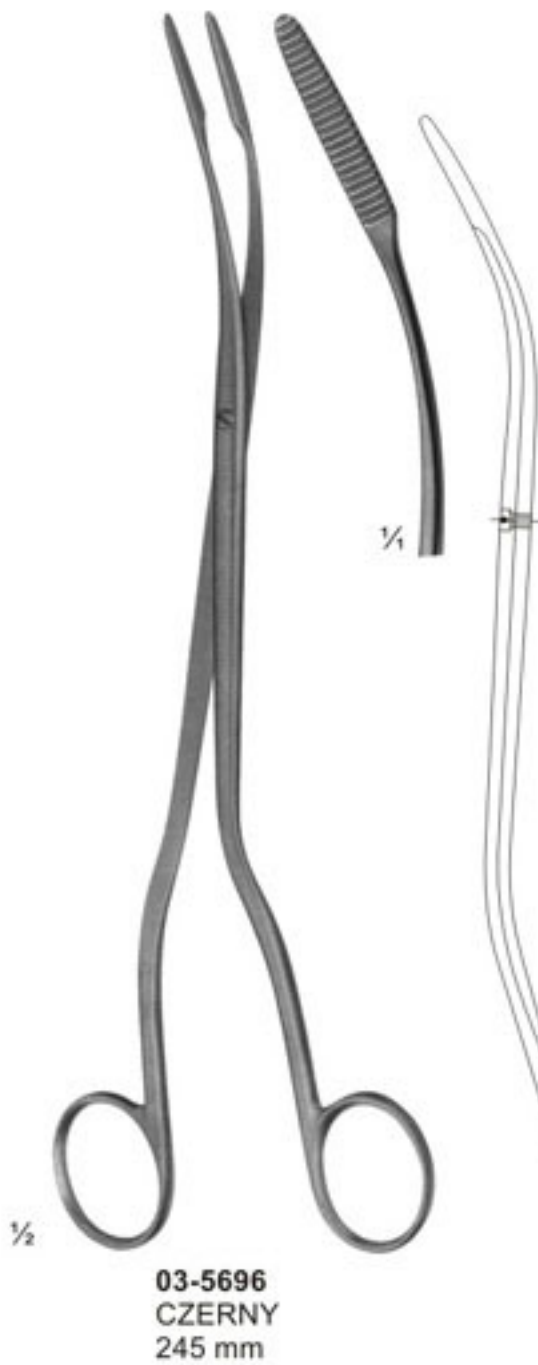



# Kidney Clamps

Atraumata

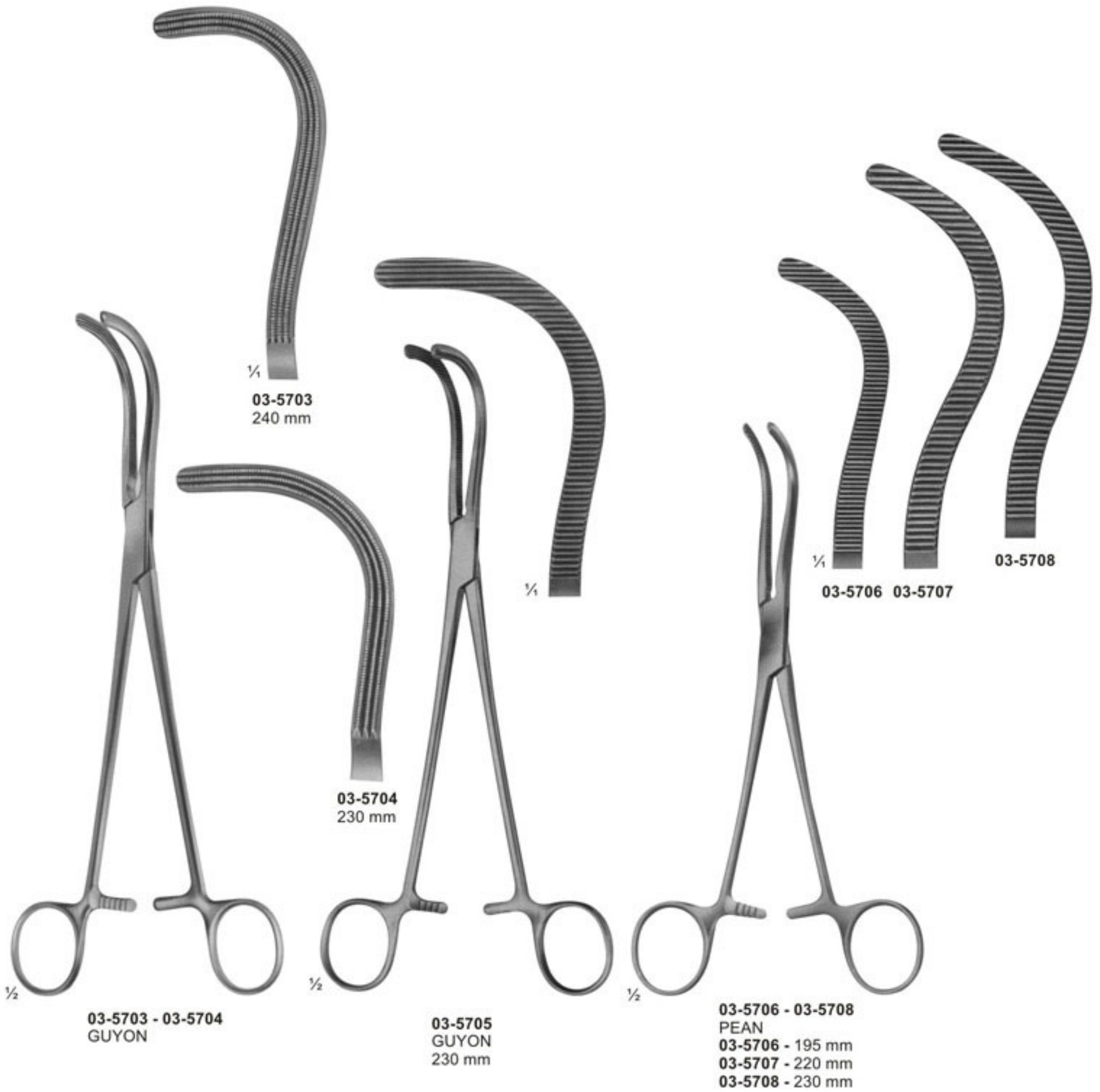





## Kidney and Pedicle Clamps

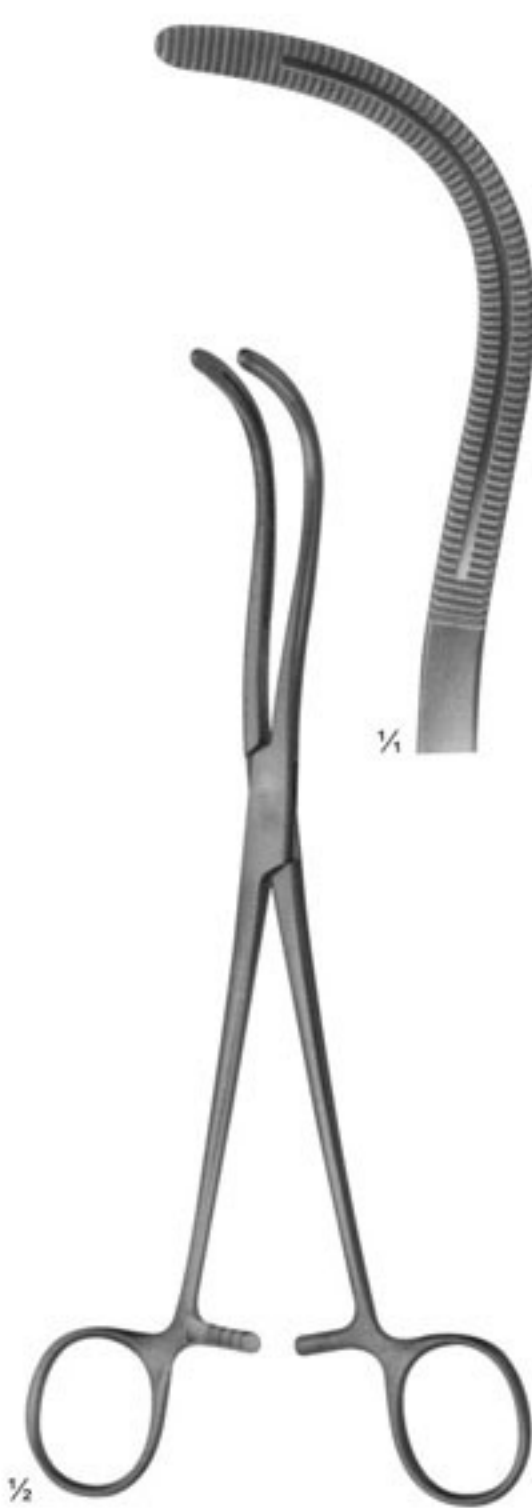

**03-5709**  
STILLE  
220 mm

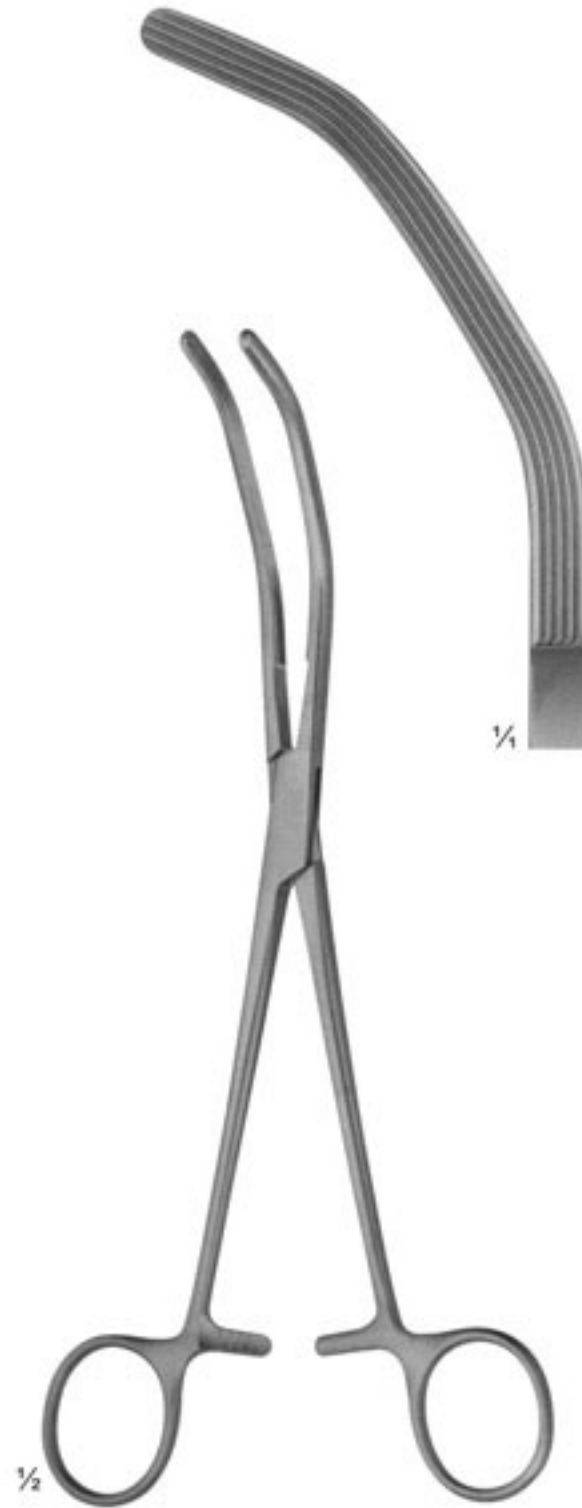

**03-5710**  
HERRICK  
225 mm



**03-5711**  
WERTHEIM  
225 mm





## Kidney Elevating Forceps



**03-5712**  
COLLIN  
285 mm



**03-5713**  
DARTIGUES  
255 mm



# Kidney Stone Forceps



03-5714



03-5715



03-5716



$\frac{1}{4}$   
03-5717



03-5718



$\frac{1}{4}$



03-5719



$\frac{1}{2}$

03-5714 - 03-5717  
RANDALL  
225 mm



$\frac{1}{2}$

03-5718 - 03-5719  
RANDALL  
190 mm





# Bladder Retractors

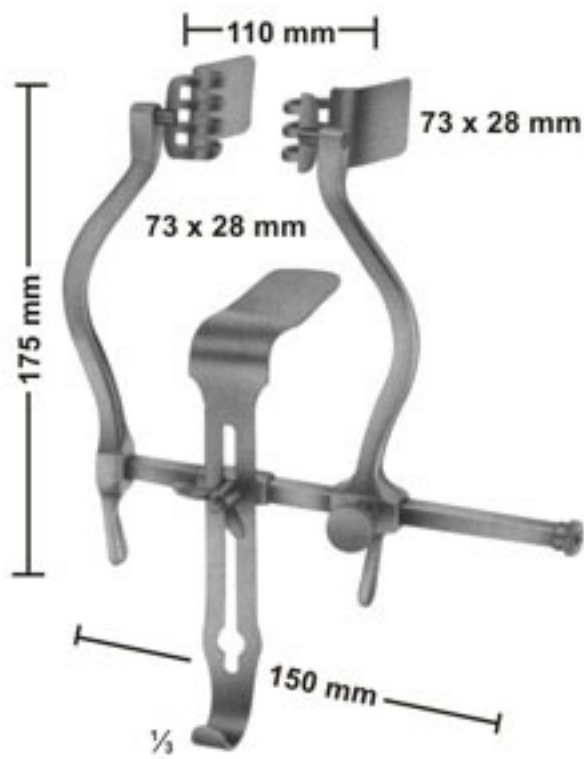

**03-5720**  
JUDD-MASSON  
Bladder-and suprapubic  
retractor

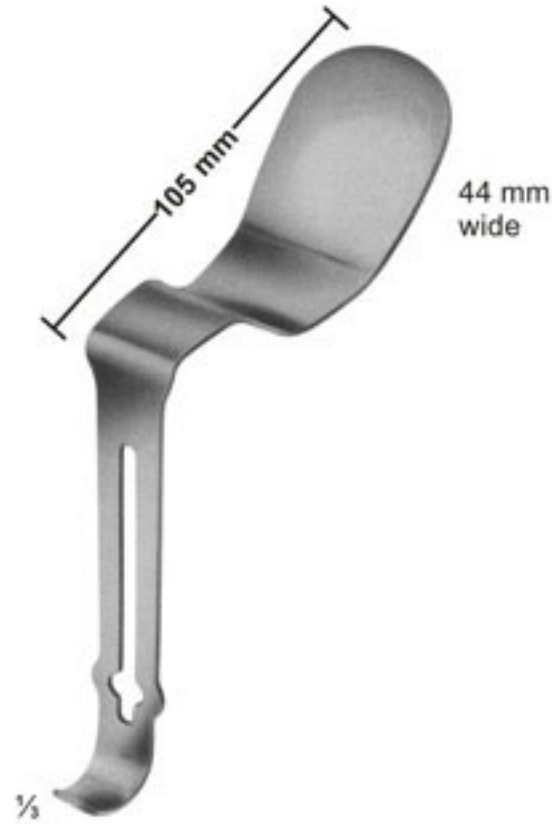

**03-5721**  
MILLIN  
Center blade for ( 05-6993)  
retro pubic prostatectomy



**03-5722**  
MILLIN  
Bladder retractor  
03-5722 Spreader only  
03-5723 Blades 57x25mm  
03-5724 Blades 82x25mm  
03-5725 Center blade 105x45mm



**03-5726**  
LEGUEU  
Bladder retractor  
Center blade  
80 x 31 mm



**03-5727**  
LEGUEU  
Bladder spatula  
260 mm

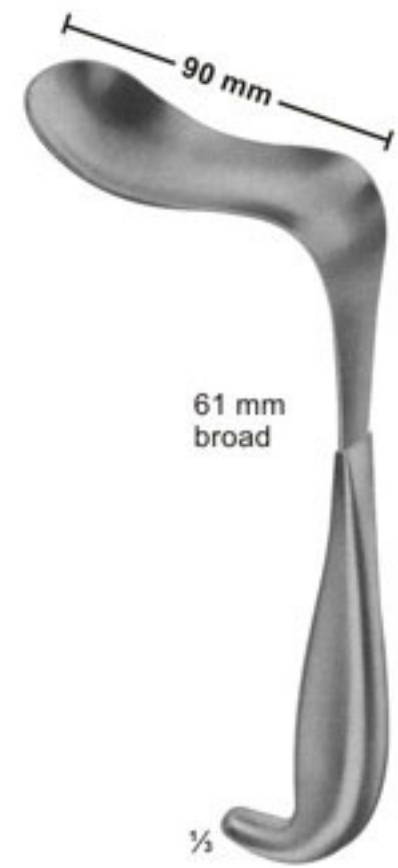

**03-5728**  
KOCHER  
Bladder spatula  
235 mm



# Genito-Urinary Instruments



03-5729  
MATHIEU  
Foreign body forceps  
Length of shaft  
190 mm

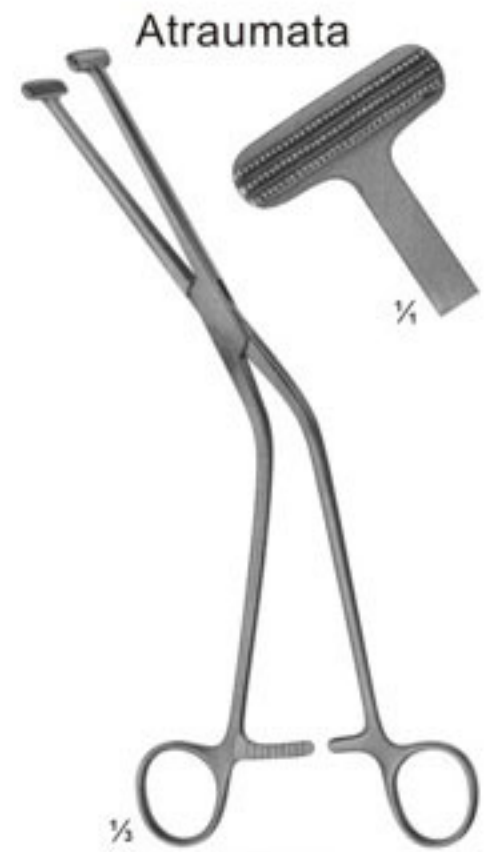

03-5730  
MILLIN  
Lobe grasping  
forceps  
235 mm

## Atraumata

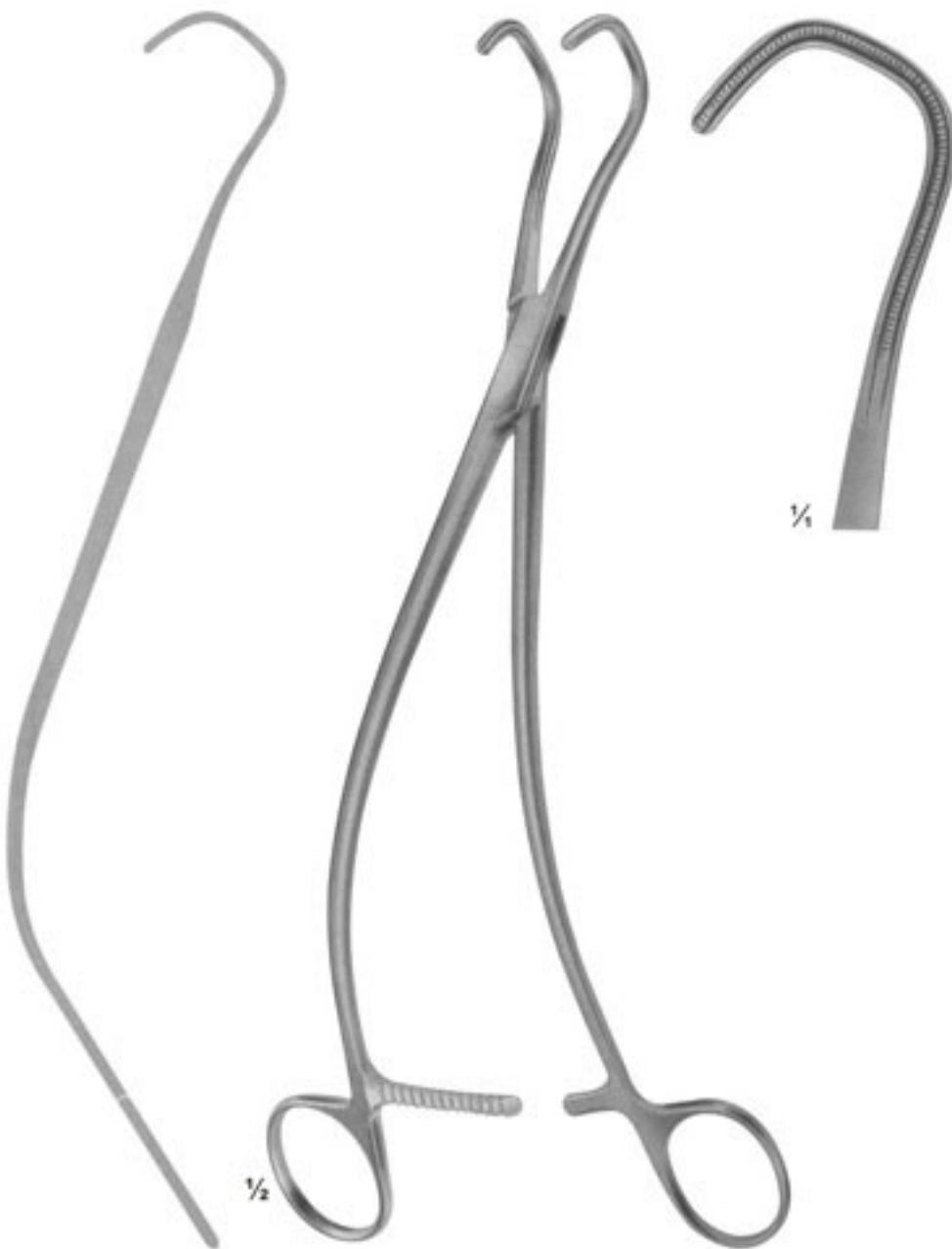

03-5731  
Ureter forceps  
240 mm

## Atraumata

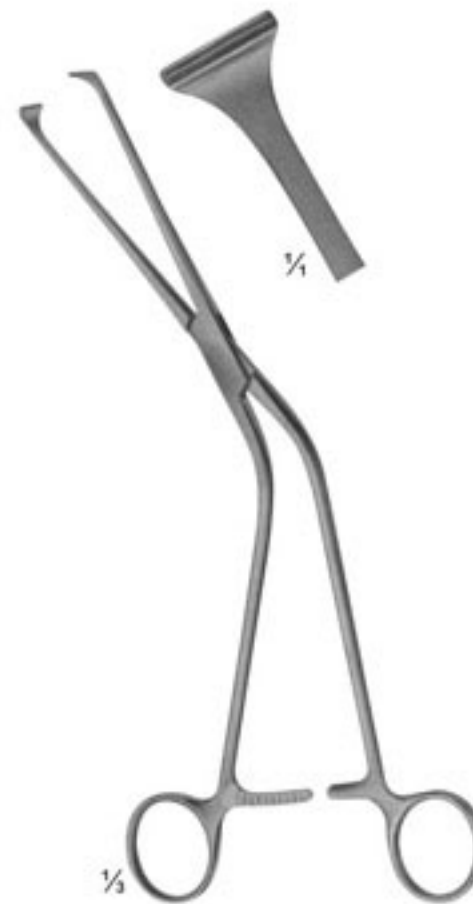

03-5732  
MILLIN  
Lobe grasping  
forceps  
245 mm



03-5733  
MILLIN  
Bladder neck spreader  
285 mm





# Genito-Urinary Instruments



**03-5734**  
GUYON  
Catheter guide  
(introducer)  
365 mm

Charr.  
(French)

- 03-5735 6
- 03-5736 7
- 03-5737 8
- 03-5738 9
- 03-5739 10
- 03-5740 11
- 03-5741 12
- 03-5742 13
- 03-5743 14
- 03-5744 15
- 03-5745 16
- 03-5746 18
- 03-5747 20

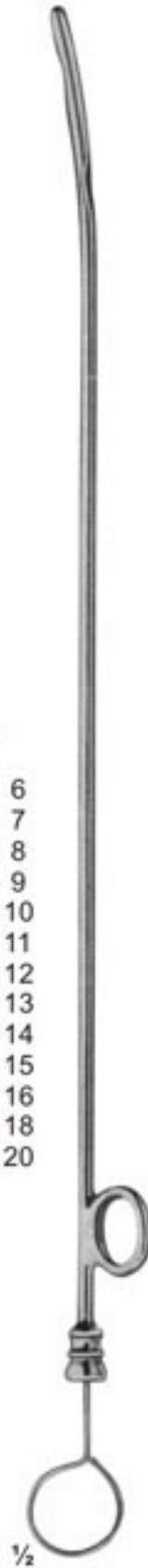

**03-5735 - 03-5747**  
Female catheters,  
metal  
160 mm

Charr.  
(French)

- 03-5748 8
- 03-5749 9
- 03-5750 10
- 03-5751 11
- 03-5752 12
- 03-5753 13
- 03-5754 14
- 03-5755 15
- 03-5756 16
- 03-5757 17
- 03-5758 18
- 03-5759 19
- 03-5760 20
- 03-5761 21
- 03-5762 22
- 03-5763 23
- 03-5764 24
- 03-5765 25
- 03-5766 26
- 03-5767 27
- 03-5768 28
- 03-5769 29
- 03-5770 30

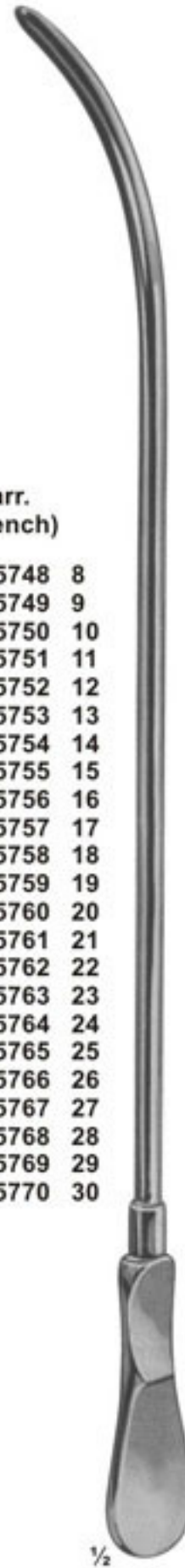

**03-5748 - 03-5770**  
DITTEL  
Urethral bougies  
and dilating sounds  
345 mm

- 03-5771 Ben. 24/Charr. 12
- 03-5772 Ben. 25
- 03-5773 Ben. 26/Charr. 13
- 03-5774 Ben. 27
- 03-5775 Ben. 28/Charr. 14
- 03-5776 Ben. 29
- 03-5777 Ben. 30/Charr. 15
- 03-5778 Ben. 31
- 03-5779 Ben. 32/Charr. 16
- 03-5780 Ben. 33
- 03-5781 Ben. 34/Charr. 17
- 03-5782 Ben. 35
- 03-5783 Ben. 36/Charr. 18
- 03-5784 Ben. 37
- 03-5785 Ben. 38/Charr. 19
- 03-5786 Ben. 39
- 03-5787 Ben. 40/Charr. 20
- 03-5788 Ben. 41
- 03-5789 Ben. 42/Charr. 21
- 03-5790 Ben. 43
- 03-5791 Ben. 44/Charr. 22
- 03-5792 Ben. 45
- 03-5793 Ben. 46/Charr. 23
- 03-5794 Ben. 47
- 03-5795 Ben. 48/Charr. 24
- 03-5796 Ben. 49
- 03-5797 Ben. 50/Charr. 25
- 03-5798 Ben. 51
- 03-5799 Ben. 52/Charr. 26
- 03-5800 Ben. 53
- 03-5801 Ben. 54/Charr. 27
- 03-5802 Ben. 55
- 03-5803 Ben. 56/Charr. 28
- 03-5804 Ben. 57
- 03-5805 Ben. 58/Charr. 29
- 03-5806 Ben. 59
- 03-5807 Ben. 60/Charr. 30

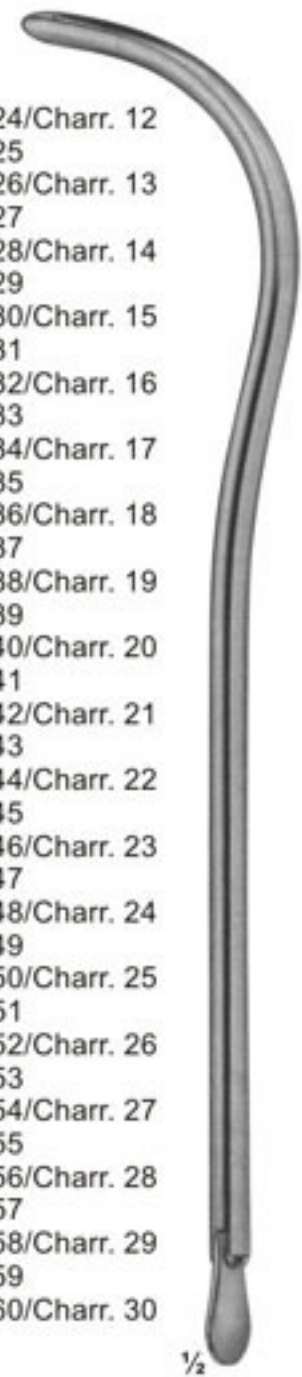

**03-5771 - 03-5807**  
GUYON  
Urethral bougies  
and dilating sounds,  
without filiform guides,  
with thread in tip  
255 mm





## Genito-Urinary Instruments & Circumcision Clamps



**03-5808**  
**GUYON**  
 Set of urethral bougies and dilating sounds, in metal case, with lift out rack and bottom rack, containing 21 urethral and dilating sounds, metal.

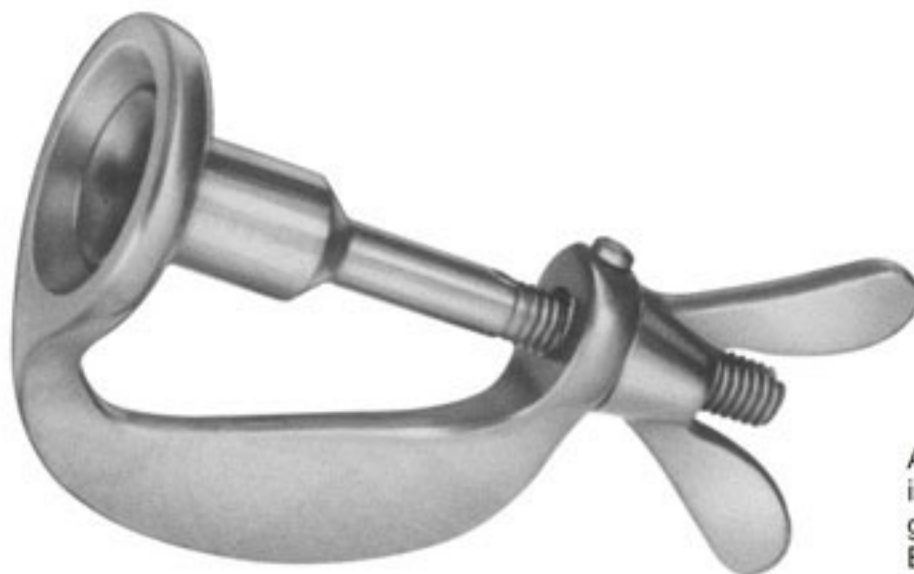

**03-5809 - 03-5811**  
**WINKELMANN**  
**03-5809** ∅ 12mm  
**03-5810** ∅ 16mm  
**03-5811** ∅ 20mm

### Circumcision Clamps

Assisted by two haemostats or ligatures the foreskin is pushed over the bellshaped protection - rod and the glans is placed into it. By now, the wing - nut is tightened as close as possible, so the foreskin in annular compressed. The foreskin is cut of with a scalpel, right next to the compression ring. The circumcision clamp remains a few minutes to avoid bleeding. In case that any large vein, specially the frenular artery, is cut through, a ligature must be set. The advantage of the method described is the cosmeticy favourable scar which is left after rejection of the small necrotized portion.





# Trocars



**Luer Lock**

**03-5812**  
KLIMA ROSEGGER  
35 X 1,8 mm  
Sternal puncture needle

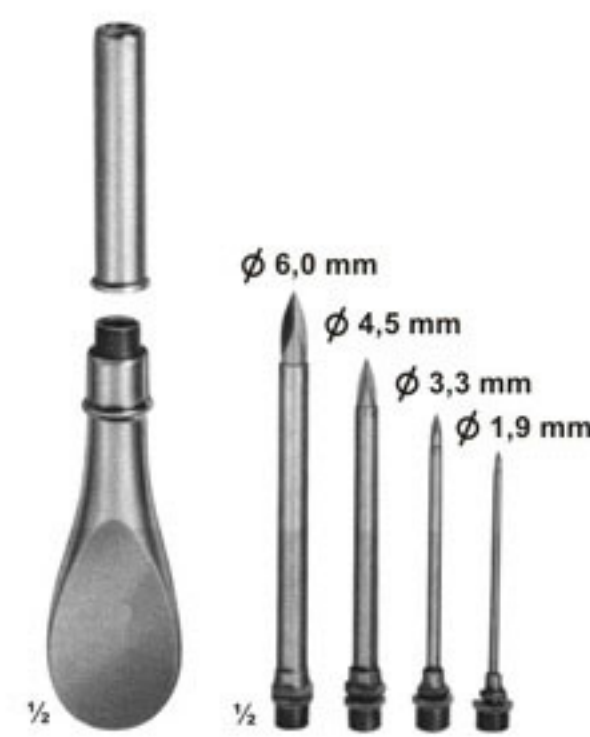

**03-5813**  
Universal trocar  
with 4 tips

Ø 6,0 mm  
Ø 4,5 mm  
Ø 3,3 mm  
Ø 1,9 mm



**03-5814 - 03-5818**  
NELSON

|                | Inside diam | Outside diam |
|----------------|-------------|--------------|
| <b>03-5814</b> | 2,2 mm      | 3,0 mm       |
| <b>03-5815</b> | 3,0 mm      | 4,0 mm       |
| <b>03-5816</b> | 4,0 mm      | 5,0 mm       |
| <b>03-5817</b> | 5,0 mm      | 6,0 mm       |
| <b>03-5818</b> | 5,5 mm      | 6,5 mm       |

for hydrocele and abdominal puncture



**03-5819 - 03-5822**

|                | Inside diam | Outside diam |
|----------------|-------------|--------------|
| <b>03-5819</b> | 2,2 mm      | 3,0 mm       |
| <b>03-5820</b> | 3,0 mm      | 4,0 mm       |
| <b>03-5821</b> | 4,0 mm      | 5,0 mm       |
| <b>03-5822</b> | 5,0 mm      | 6,0 mm       |

for abdominal puncture,  
with stop-cock and lateral drain

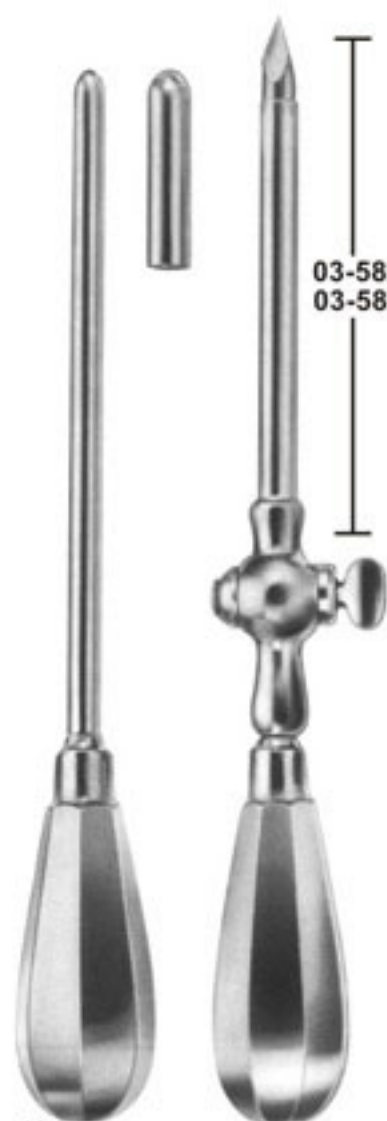

**03-5823** 100 mm  
**03-5824** 110 mm

**03-5823 - 03-5824**  
BUELAU

|                | Inside diam | Outside diam |
|----------------|-------------|--------------|
| <b>03-5823</b> | 6,5 mm      | 8,0 mm       |
| <b>03-5824</b> | 9,0 mm      | 10,0 mm      |

Empyema trocar

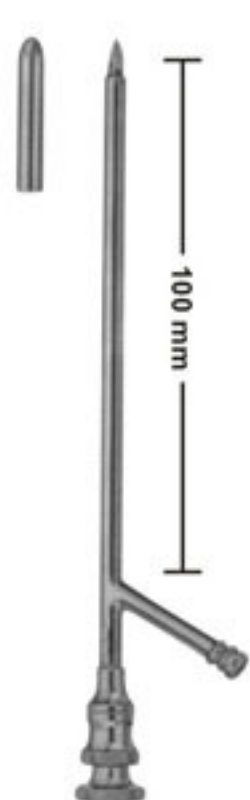

**03-5825 - 03-5828**  
OCHSNER

|                | Inside diam | Outside diam |
|----------------|-------------|--------------|
| <b>03-5825</b> | 3,0 mm      | 4,0 mm       |
| <b>03-5826</b> | 3,6 mm      | 4,6 mm       |
| <b>03-5827</b> | 4,3 mm      | 5,3 mm       |
| <b>03-5828</b> | 5,0 mm      | 6,0 mm       |

Gall bladder trocars



**Record Cone 1**

**03-5829**  
PIERCE  
Antrum trocar  
Ø 4,0 mm



**Luer Lock Cone**

**03-5830**  
COAKLEY  
Antrum trocar  
Ø 3,0 mm