

## Section - 03



- ★ Hooks, Retractors, Spatulas, Spreaders, Abdoninal Retractors
- ★ Forceps, intestinal Clamps, Specula, Biopsy Forceps, Anuscopes
- ★ Gall Duct Forceps / Probes / Scissors / Kidney Forceps, Urinary Instruments, Trocars

**Pages 115-208**



# Nerve - and Vessel Hooks

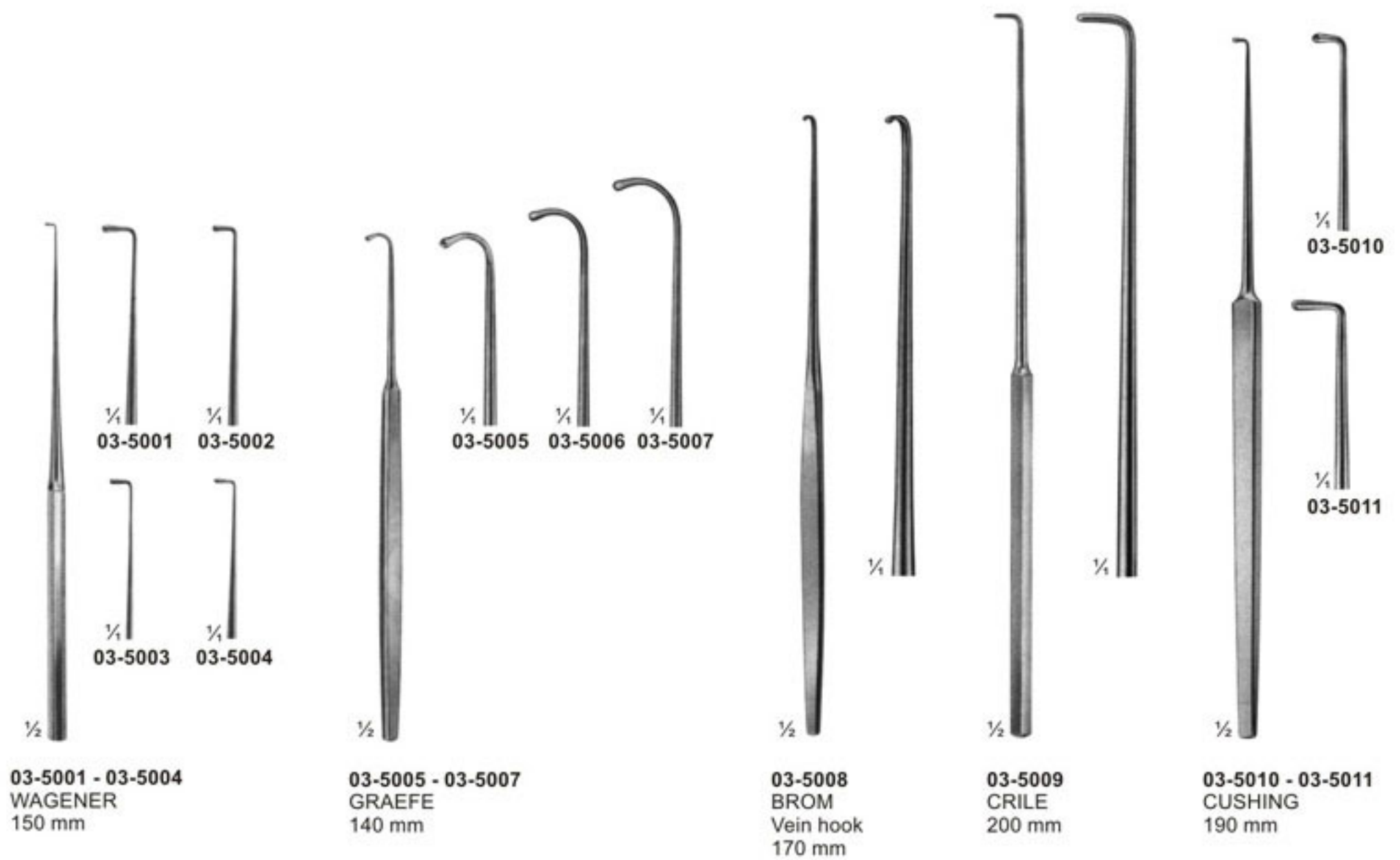



# Nerve - and Vessel Hooks

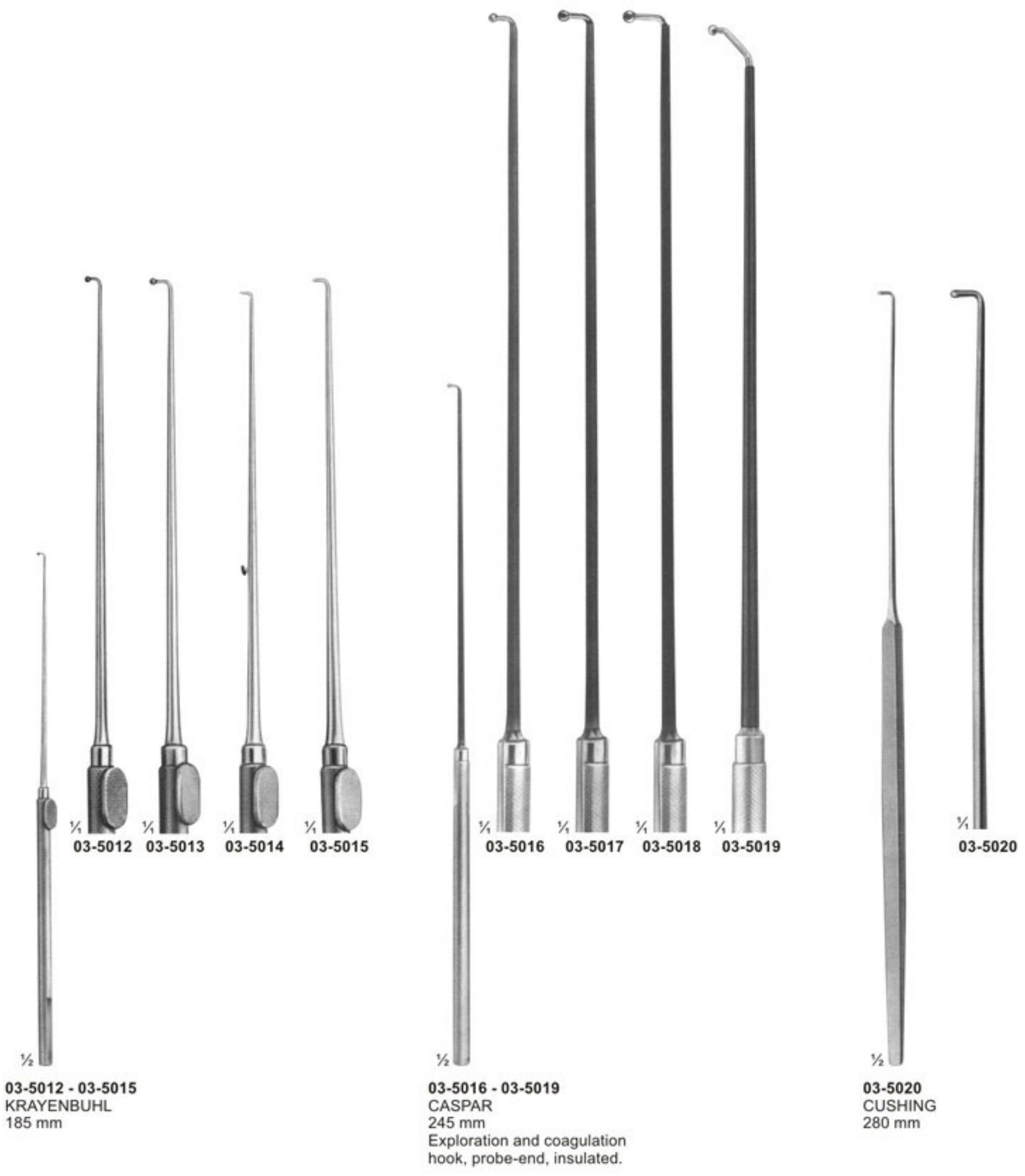











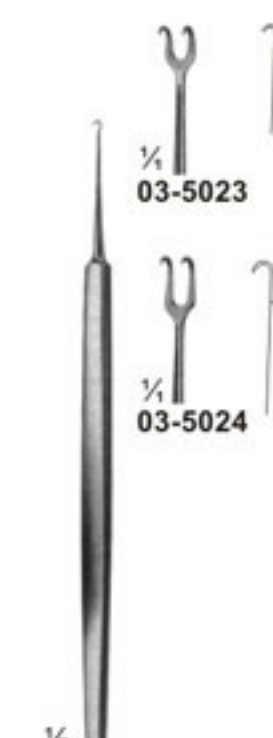

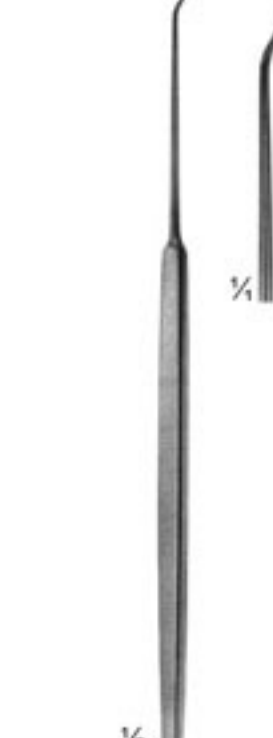

$\frac{1}{2}$   
**03-5012 - 03-5015**  
KRAYENBUHL  
185 mm

$\frac{1}{2}$   
**03-5016 - 03-5019**  
CASPAR  
245 mm  
Exploration and coagulation  
hook, probe-end, insulated.

$\frac{1}{2}$   
**03-5020**  
CUSHING  
280 mm

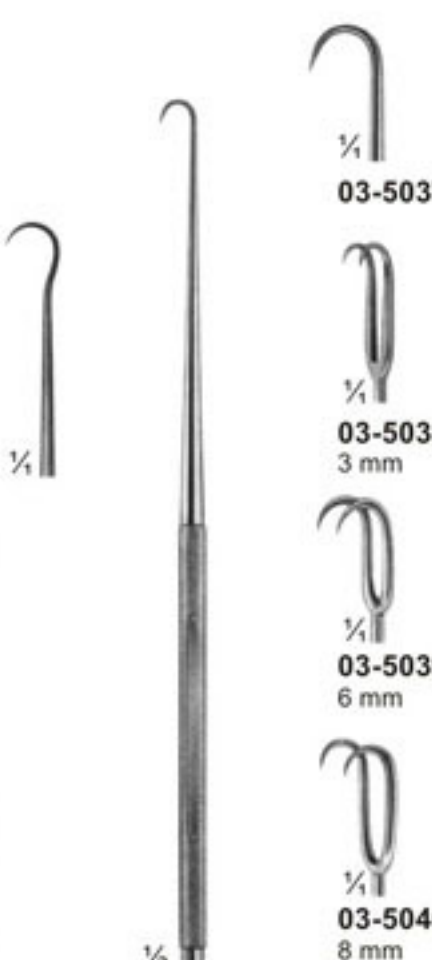

Fine Wound Retractors (Dura- and Skin Retractors)

 <p>03-5021 03-5022</p>	 <p>03-5023 03-5024</p>	 <p>03-5025 03-5026 03-5027</p>	 <p>03-5028</p>	 <p>03-5029</p>	 <p>03-5030</p>	 <p>03-5031</p>		
<p>03-5021 - 03-5022 03-5021 Sharp 03-5022 Blunt GRAEFE 125 mm</p>	<p>03-5023 - 03-5024 03-5023 125 mm 03-5024 130 mm Sharp GUTHRIE</p>	<p>03-5025 - 03-5027 03-5025 130 mm 03-5026 135 mm Sharp 03-5027 135 mm Blunt ROLLET</p>	<p>03-5028 FRAZIER Dura Retractor 130 mm</p>	<p>03-5029 TOENNIS Dura Retractor 150 mm</p>	<p>03-5030 KILNER 160 mm</p>	<p>03-5031 FREER 150 mm</p>		
 <p>03-5032</p>	 <p>03-5033</p>	 <p>03-5034</p>	 <p>03-5035</p>	 <p>03-5036</p>	 <p>03-5037 03-5038 03-5039 03-5040</p>	 <p>03-5041 03-5042</p>	 <p>03-5043</p>	 <p>03-5044</p>
<p>03-5032 MULLER 150 mm</p>	<p>03-5033 MULLER 150 mm</p>	<p>03-5034 COTTLE 160 mm</p>	<p>03-5035 COTTLE 160 mm</p>	<p>03-5036 JAEGER 135 mm</p>	<p>03-5037 - 03-5040 JOSEPH 165 mm</p>	<p>03-5041 - 5042 GILLIES 180 mm</p>	<p>03-5043 KILNER Sharp 80 mm</p>	<p>03-5044 CONVERSE Blunt 120 mm</p>



# Wound - Trachea Retractors

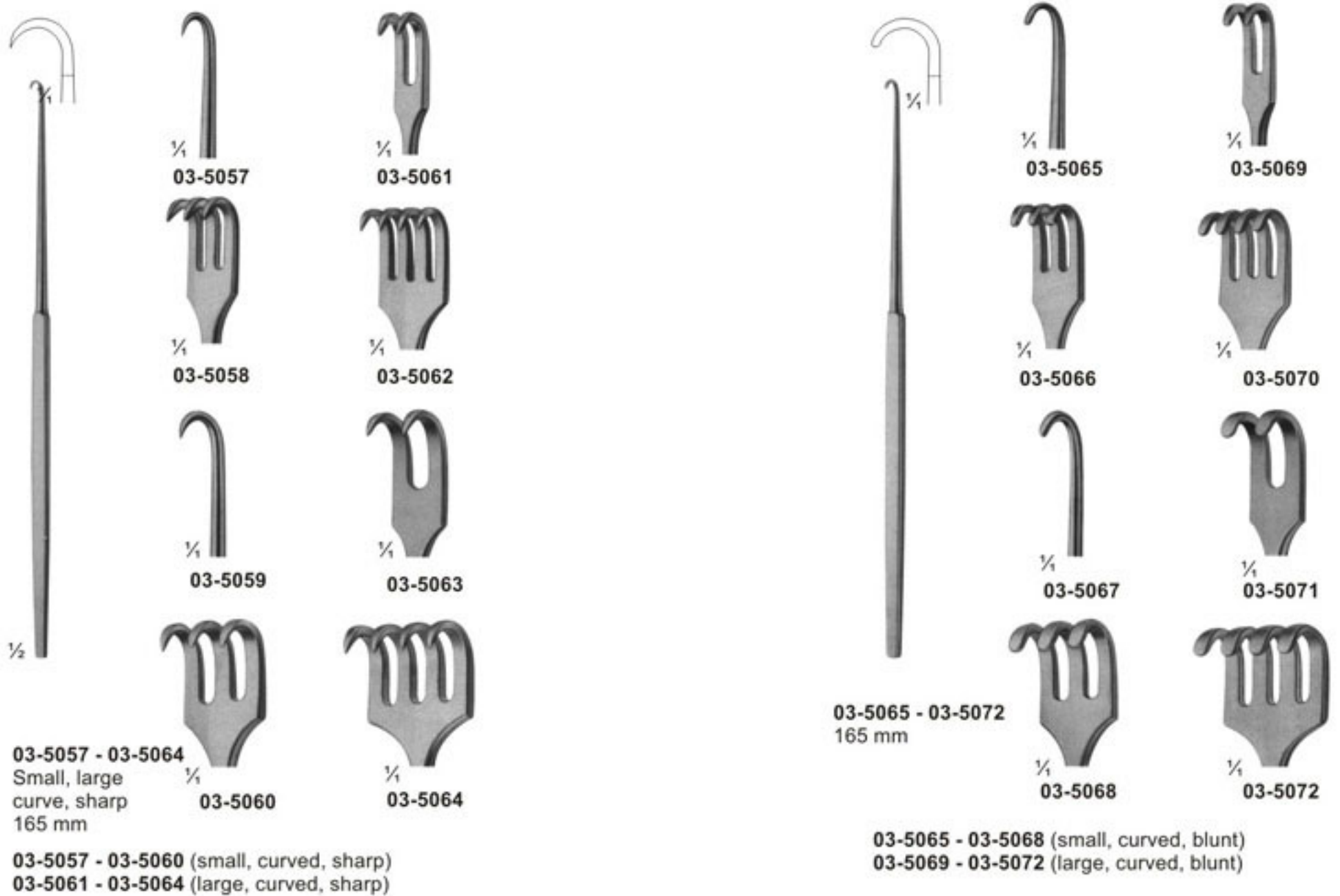



# Retractors With Treangle Handle

<p>1/2</p>	<p>1/4</p>	<p>1/4</p>	<p>1/4</p>	<p>1/4</p>	<p>1/4</p>					
<p><b>03-5073</b> MANNERFELT modif. sharp 135 mm</p>	<p><b>03-5074</b> MANNERFELT modif. sharp 155 mm</p>	<p><b>03-5075</b> MANNERFELT modif. sharp 155 mm</p>	<p><b>03-5076 - 03-5078</b> MANNERFELT modif. Small curve, sharp 155 mm</p>		<p><b>03-5079 - 03-5081</b> MANNERFELT modif. Large curve, blunt 155 mm</p>					
<p>1/2</p>	<p><b>03-5082</b> 15 x 6 mm</p>	<p><b>03-5083</b> 20 x 6 mm</p>	<p><b>03-5084</b> 25 x 6 mm</p>	<p><b>03-5085</b> 30 x 8 mm</p>	<p>1/2</p>	<p><b>03-5086</b> 12 x 12 mm</p>	<p><b>03-5087</b> 12 x 14 mm</p>	<p><b>03-5088</b> 14 x 16 mm</p>	<p>1/2</p>	<p>12 x 12 mm</p> <p>1/4</p>
<p><b>03-5082 - 03-5085</b> LANGENBECK- MANNERFELT modif. 155 mm</p>					<p><b>03-5086 - 03-5088</b> MANNERFELT modif. Saddle hooks, 155 mm</p>			<p><b>03-5089</b> MANNERFELT modif. Saddle hooks, fenestrated 155 mm</p>		



Retractors

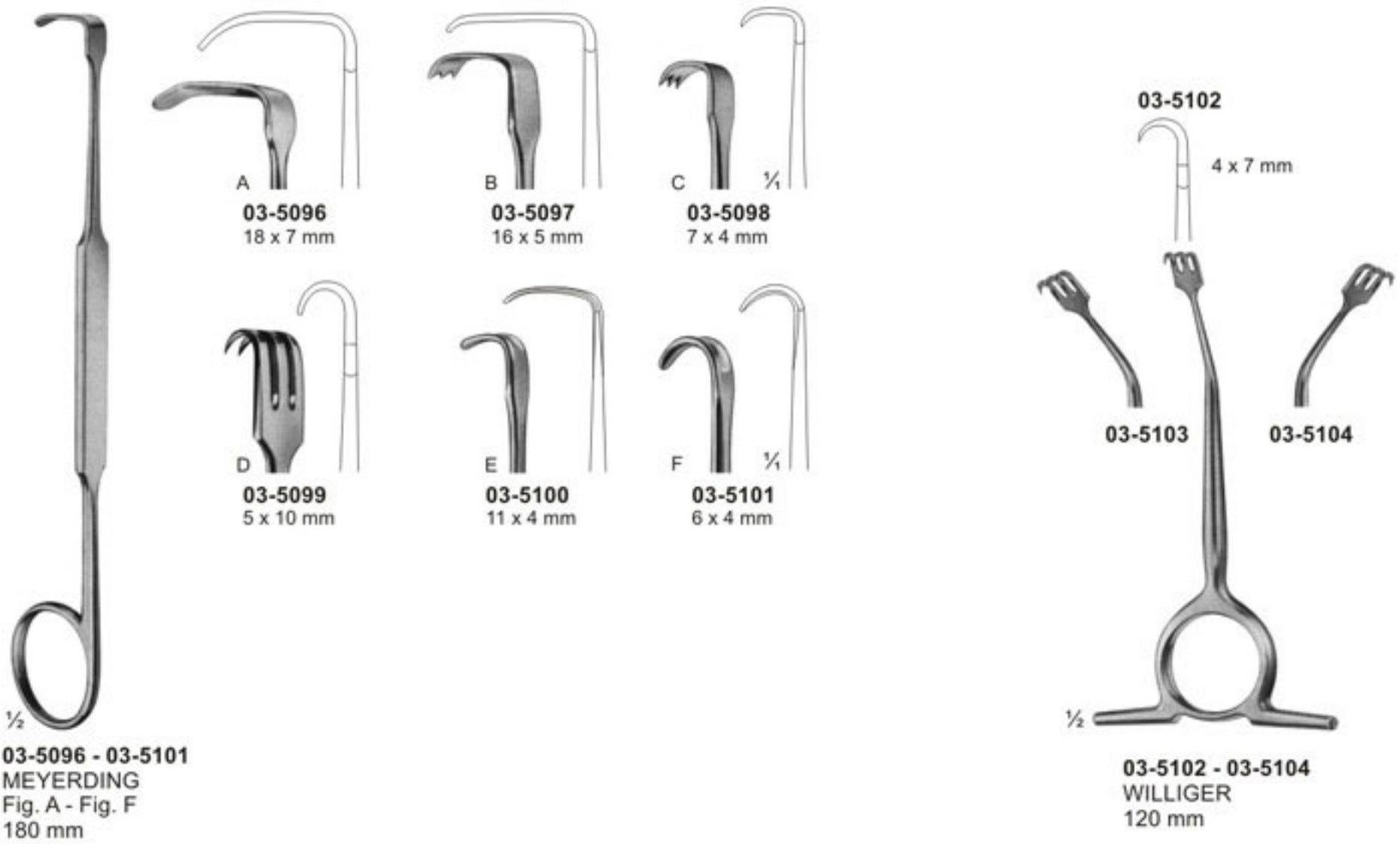



# Retractors



**03-5105**  
EMMET  
Fistula hook  
220 mm



**03-5106**  
SIMON  
Fistula hook  
220 mm

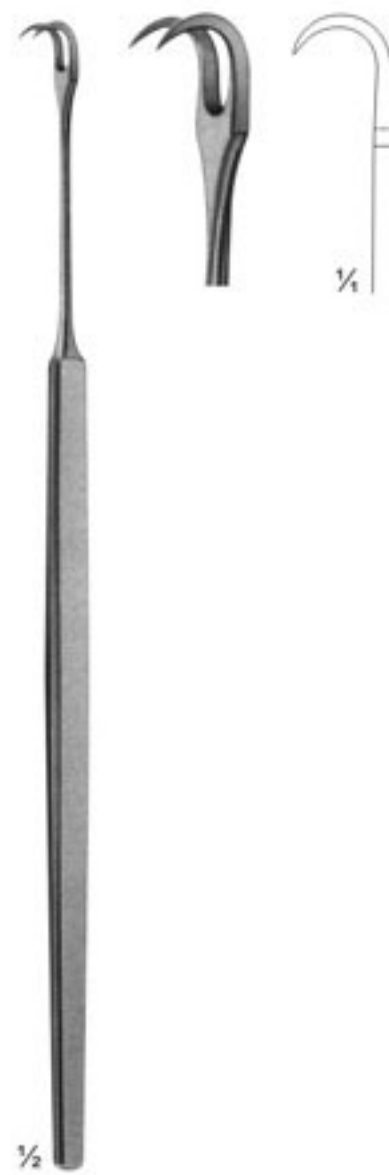

**03-5107**  
SIMON  
Fistula hook  
220 mm



**03-5108**  
LANGE  
Fistula hook  
230 mm



12 x 6 mm

**03-5109**

12 x 11 mm

**03-5110**

**03-5109 - 03-5110**  
Tendon hooks  
175 mm

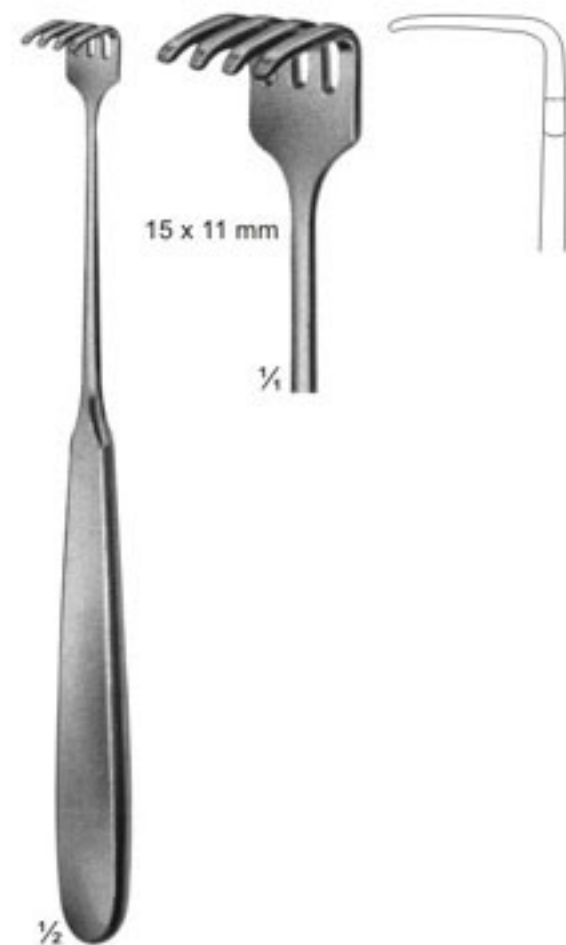

15 x 11 mm

1/4

**03-5111**  
KLAPP  
Tendon hooks  
175 mm





# Wound and Vein Retractors

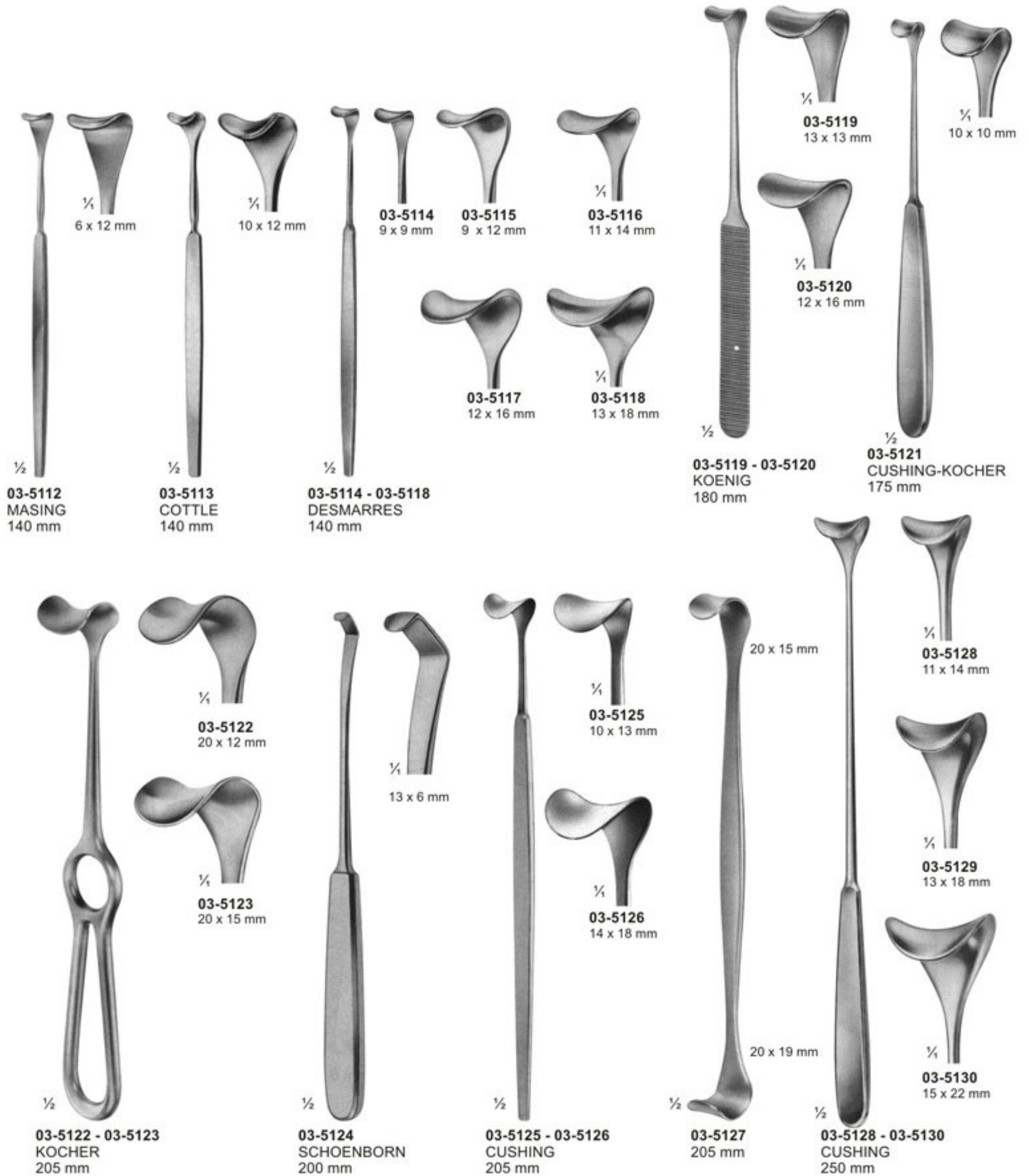



# Retractors



**03-5131 - 03-5132**  
BABY-SENN-MILLER  
155 mm

**03-5133**  
SENN-MILLER  
165 mm

**03-5134**  
COLLIN-HARTMANN  
150 mm

**03-5135 - 03-5137**  
STERNBERG  
03-5135 120 mm  
03-5136 130 mm  
03-5137 135 mm

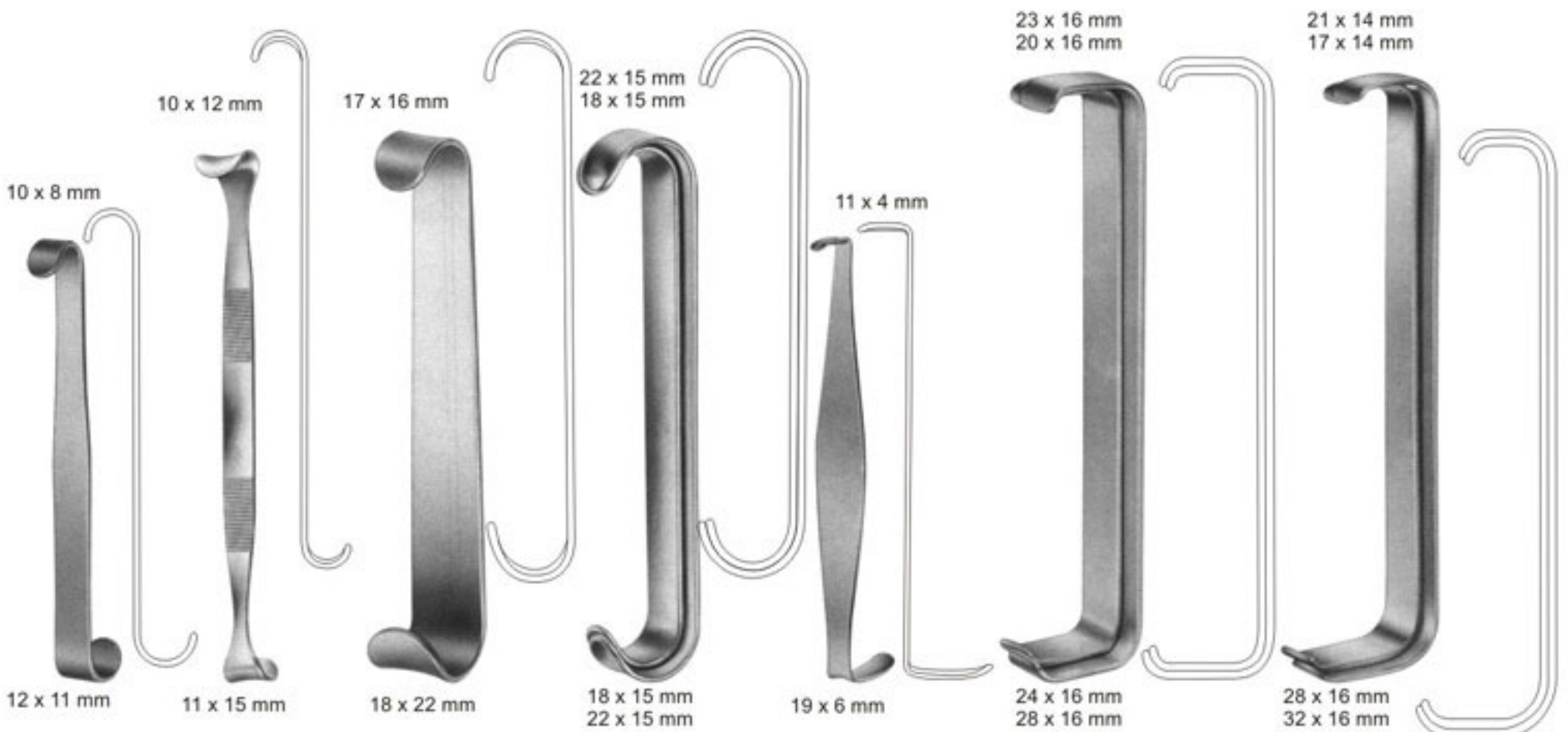

**03-5138**  
LUER  
110 mm

**03-5139**  
ROSE  
130 mm

**03-5140**  
BABY-ROUX  
135 mm

**03-5141**  
PARKER  
135 mm

**03-5142**  
CRILE  
110 mm

**03-5143**  
FARABEUF  
150 mm

**03-5144**  
COLLIN  
150 mm



# Retractors

 <p><b>03-5145</b> ROUX Set 165 mm</p>	 <p>19 x 22 mm <b>03-5146</b> 23 x 30 mm</p>	 <p>25 x 26 mm <b>03-5147</b> 28 x 38 mm</p>	 <p>28 x 29 mm <b>03-5148</b> 33 x 45 mm</p>	 <p><b>03-5149</b> ROUX</p>	 <p>20 x 22 mm <b>03-5150</b> 25 x 29 mm 150mm</p>	 <p>25 x 26 mm <b>03-5151</b> 30 x 38 mm 160mm</p>
 <p><b>03-5152</b> CZERNY 175 mm</p>	 <p>36 mm <b>03-5153</b> MATHIEU 200 mm</p>	 <p>47 x 13 mm 41 x 13 mm <b>03-5154</b> US-ARMY 220 mm</p>	 <p>37 x 25 mm 42 x 25 mm <b>03-5155</b> 38 x 42 mm</p>	 <p>26 x 15 mm 22 x 15 mm <b>03-5156</b> 26 x 15 mm 22 x 15 mm</p>	 <p>39 x 15 mm 43 x 15 mm <b>03-5157</b> 39 x 15 mm 43 x 15 mm</p>	



# Bone Retractors and Retractors



**03-5155**  
KOCHER  
Sharp  
205 mm



**03-5156**  
KOCHER  
Sharp  
220 mm



**03-5157**  
VOLKMANN  
Sharp  
220 mm



**03-5158**  
VOLKMANN  
Blunt  
220 mm



**03-5159**  
VOLKMANN  
Sharp  
220 mm



**03-5160 - 03-5167**  
VOLKMANN  
225 mm



Sharp

1/4



**03-5160**  
9 x 8 mm



**03-5161**  
9 x 13 mm



**03-5162**  
9 x 19 mm



**03-5163**  
9 x 29 mm



Blunt

1/4



**03-5164**  
8,5 x 8 mm



**03-5165**  
8,5 x 13 mm



**03-5166**  
8,5 x 19 mm



**03-5167**  
8,5 x 29 mm



# Retractors

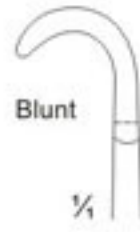
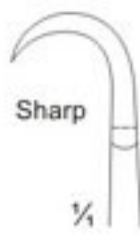
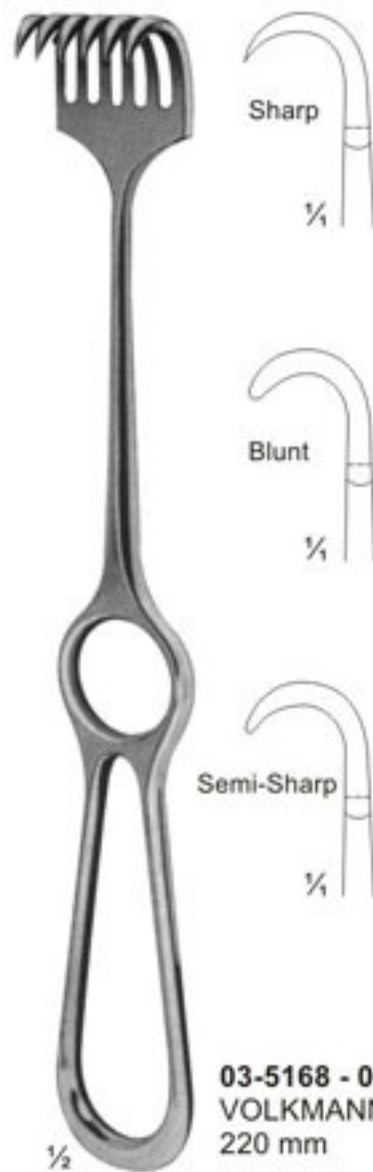

**03-5168 - 03-5181**  
VOLKMANN  
220 mm



**03-5168**  
9 x 8 mm



**03-5169**  
9 x 13 mm



**03-5170**  
9 x 19 mm



**03-5171**  
9 x 29 mm



**03-5172**  
9 x 40 mm



**03-5173**  
8 x 8 mm



**03-5174**  
8 x 13 mm



**03-5175**  
8 x 19 mm



**03-5176**  
8 x 29 mm



**03-5177**  
8 x 40 mm



**03-5178**  
8,5 x 8 mm



**03-5179**  
8,5 x 13 mm



**03-5180**  
8,5 x 19 mm



**03-5181**  
8,5 x 29 mm

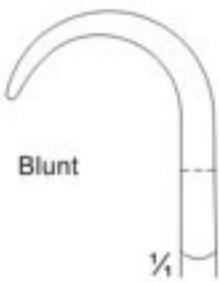
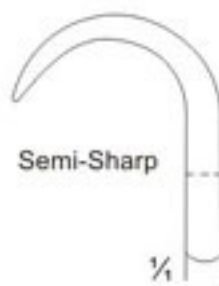

**03-5182 - 03-5189**  
KOCHER  
220 mm



**03-5182**  
16 x 9 mm



**03-5183**  
16 x 14 mm



**03-5184**  
16 x 20 mm



**03-5185**  
16 x 30 mm



**03-5186**  
15,5 x 9 mm



**03-5187**  
15,5 x 14 mm



**03-5188**  
15,5 x 20 mm



**03-5189**  
15,5 x 30 mm



# Retractors, Deep form



**03-5190 - 03-5191**  
KOERTE  
Handle vertical  
to the blade.  
240 mm



**03-5192 - 03-5195**  
ISRAEL  
255 mm

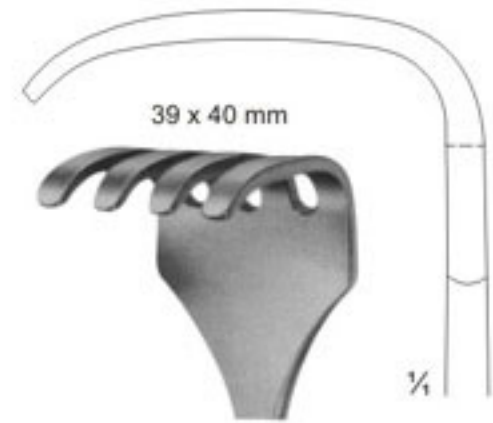

**03-5192**  
4 Prongs, blunt

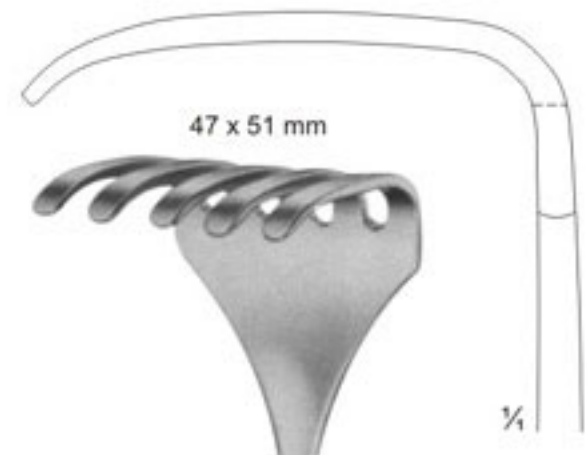

**03-5193**  
5 Prongs, blunt



**03-5194**  
6 Prongs, blunt

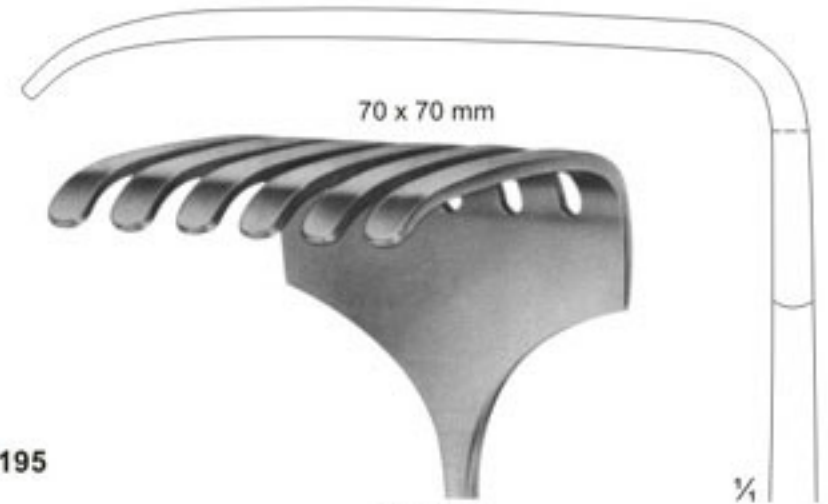

**03-5195**  
6 Prongs, blunt



# Retractors



03-5196 - 03-5201  
LANGENBECK  
210 mm

- 03-5196 28 x 10 mm
- 03-5197 28 x 14 mm
- 03-5198 33 x 14 mm
- 03-5199 28 x 16 mm
- 03-5200 40 x 10 mm
- 03-5201 40 x 13 mm



03-5202 - 03-5210  
KOCHER-LANGENBECK  
215 mm

- 03-5202 25 x 6 mm
- 03-5203 35 x 8 mm
- 03-5204 35 x 11 mm
- 03-5205 35 x 15 mm
- 03-5206 41 x 11 mm
- 03-5207 55 x 11 mm
- 03-5208 70 x 14 mm
- 03-5209 80 x 12mm
- 03-5210 80 x 16mm



03-5211  
LANGENBECK  
215 mm



# Retractors



**03-5212 - 03-5216**  
KOCHER  
230 mm

1/2



**03-5217 - 03-5219**  
SAUERBRUCH  
225 mm

1/2



**03-5212**  
40 x 18 mm

1/4



**03-5213**  
60 x 20 mm

1/4



**03-5214**  
60 x 25 mm

1/4

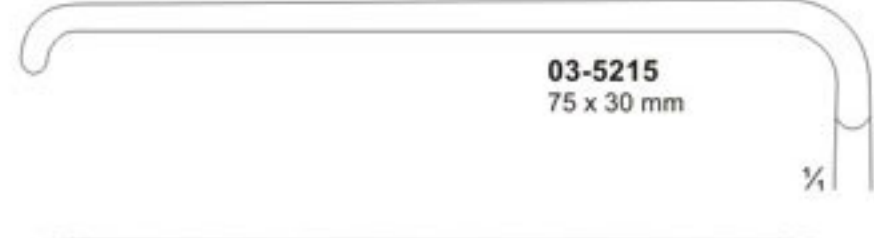

**03-5215**  
75 x 30 mm

1/4

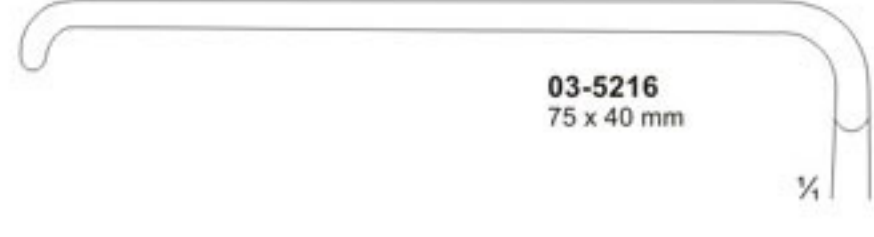

**03-5216**  
75 x 40 mm

1/4

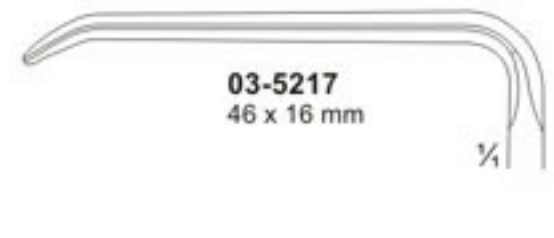

**03-5217**  
46 x 16 mm

1/4

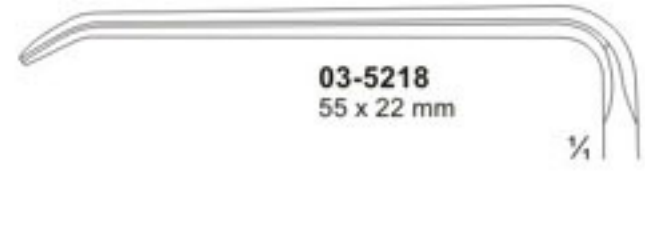

**03-5218**  
55 x 22 mm

1/4

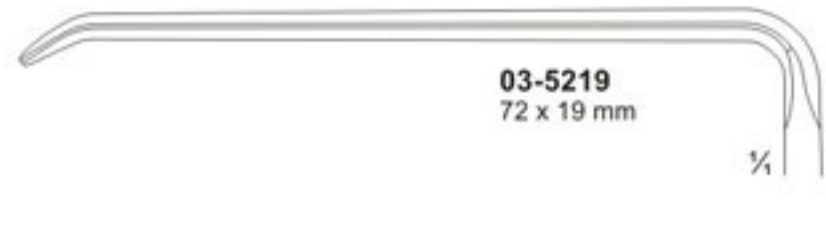

**03-5219**  
72 x 19 mm

1/4





# Retractors

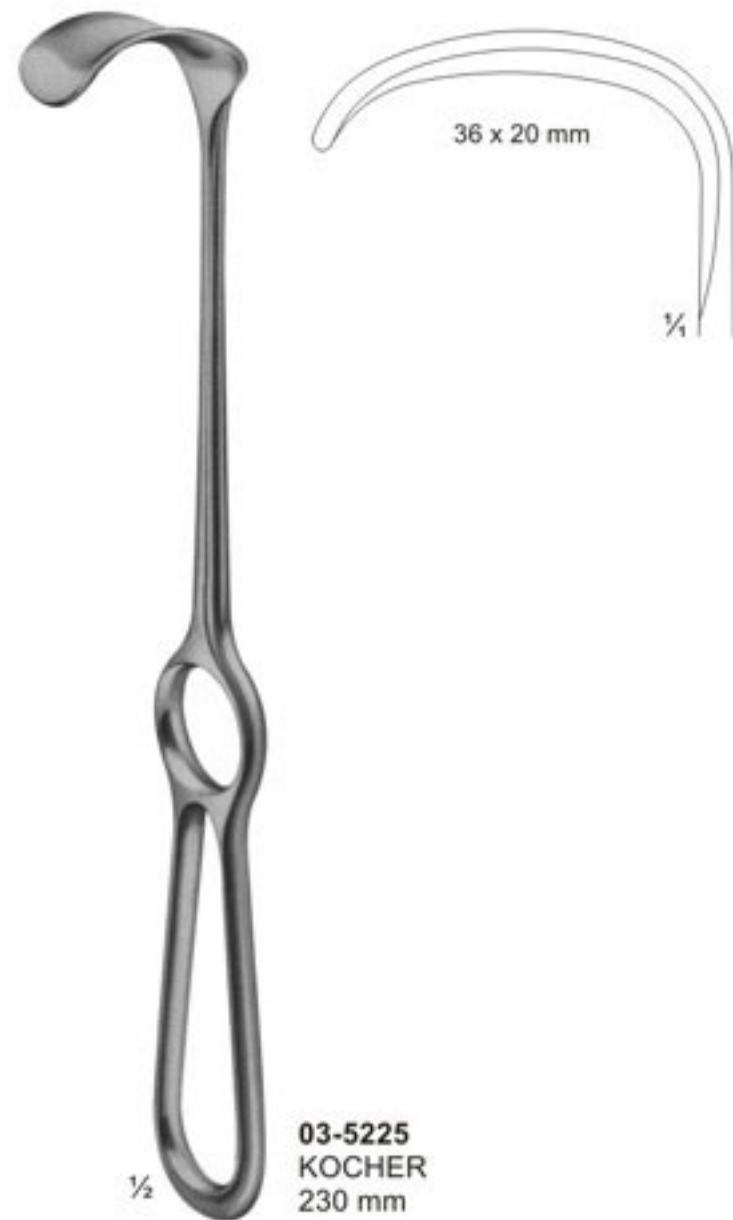
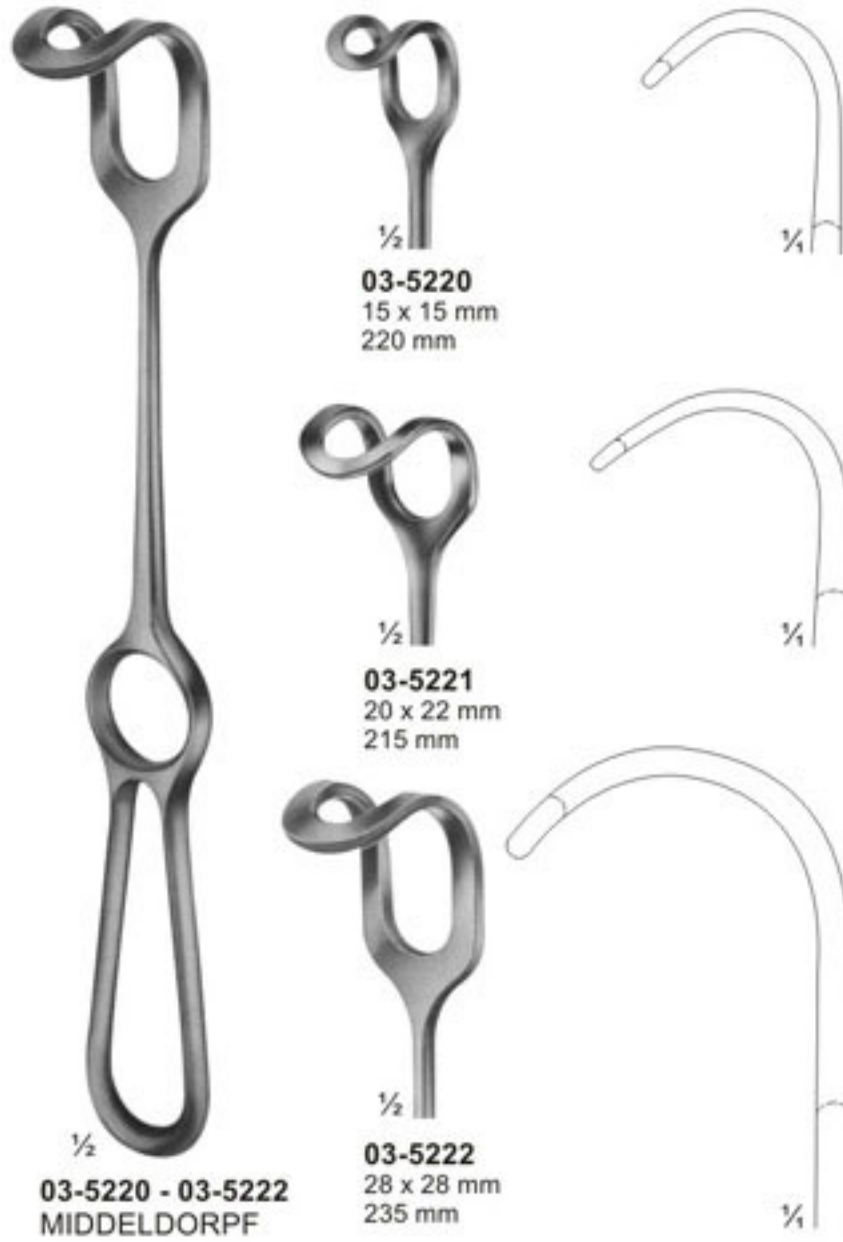



# Retractors



½

**03-5226 - 03-5231**  
HOSEL  
250 mm

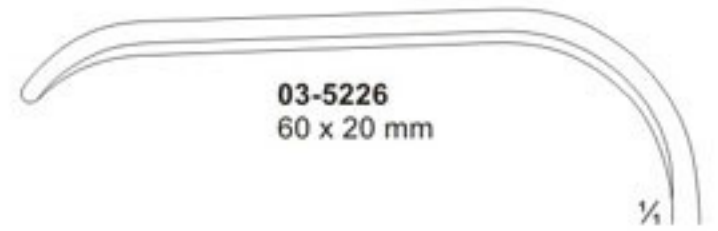

**03-5226**  
60 x 20 mm

¼

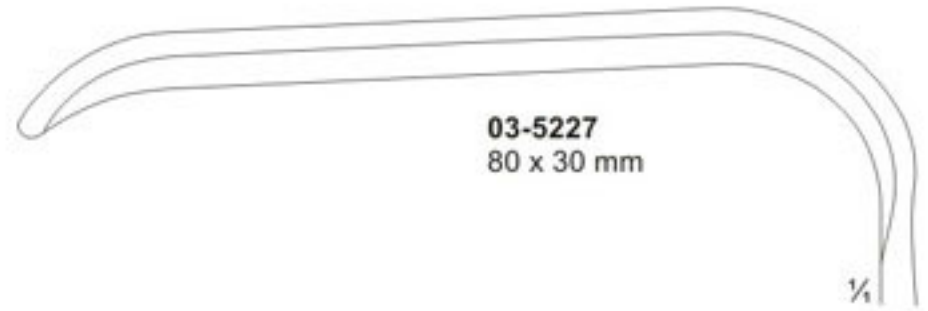

**03-5227**  
80 x 30 mm

¼



**03-5228**  
100 x 30 mm

¼

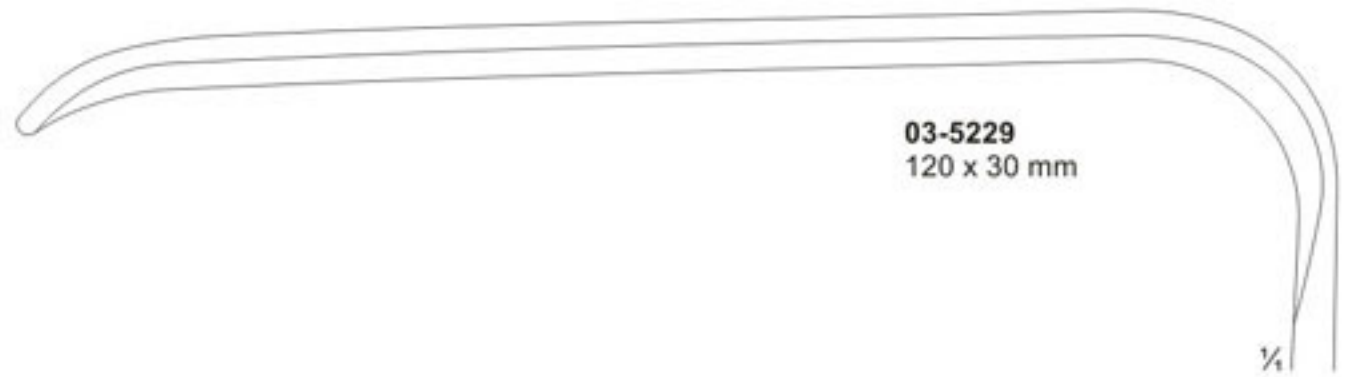

**03-5229**  
120 x 30 mm

¼



**03-5230**  
140 x 30 mm

¼



**03-5231**  
140 x 40 mm

¼



# Retractors

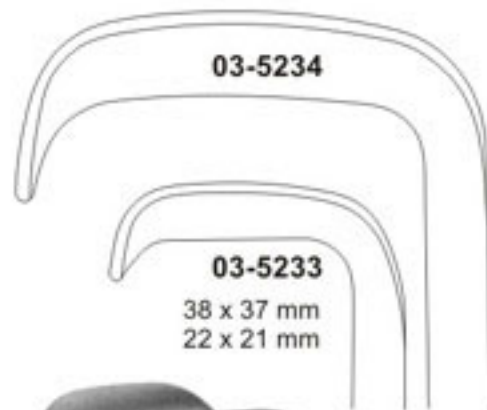

03-5234



03-5233  
38 x 37 mm  
22 x 21 mm



03-5235  
23 x 20 mm



03-5236  
30 x 29 mm



03-5237  
37 x 37 mm



47 x 21 mm



1/2

29 x 30 mm  
64 x 43 mm

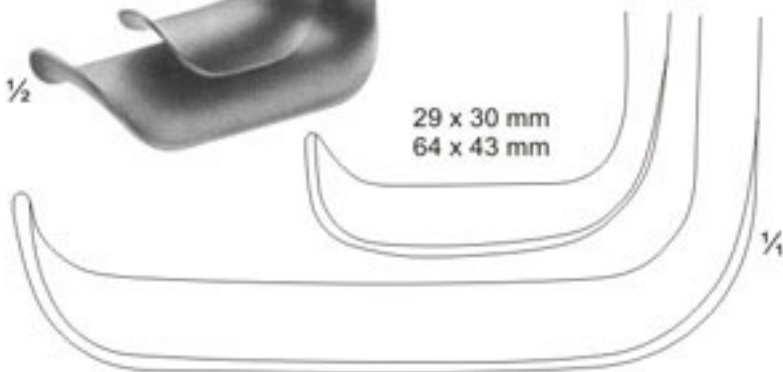

1/4

03-5232  
RICHARDSON-EASTMAN  
Set  
03-5232 250 mm  
03-5233 270 mm  
03-5234  
Richardson - Eastman  
complete set of 2



1/2

03-5235 - 03-5237  
RICHARDSON  
240 mm

1/2

03-5238  
RICHARDSON  
240 mm



# Retractors

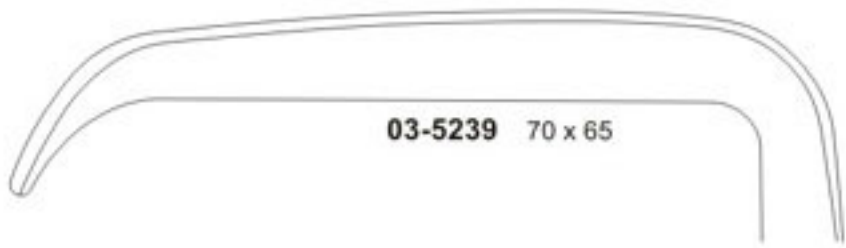

03-5239 70 x 65

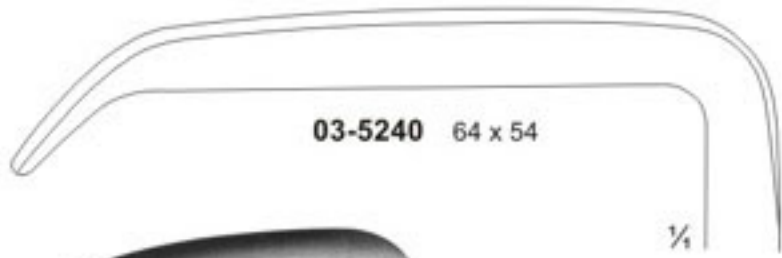

03-5240 64 x 54



1/2

03-5239 - 03-5240  
KELLY  
260 mm



03-5241 70 x 50  
03-5242 70 x 65



1/2

03-5241 - 03-5242  
MORRIS  
245 mm



# Retractors For Deep Surgery



03-5243 - 03-5245  
MEYERDING



# Retractors For Deep Surgery

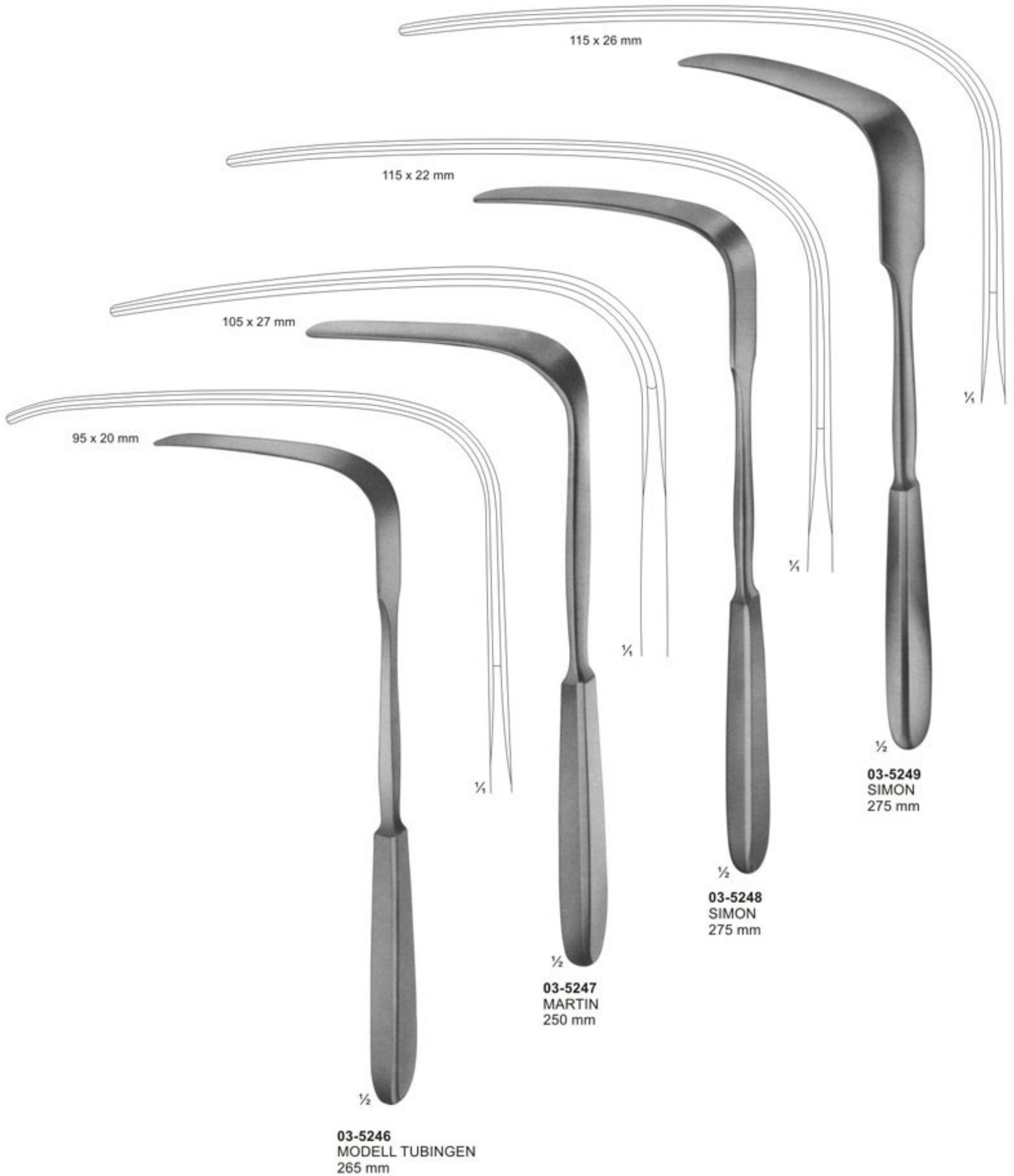



Retractors, Vario Retractor System, Germ. Fed. Patent, Germ. Fed. Regd.Des, US-Patent.

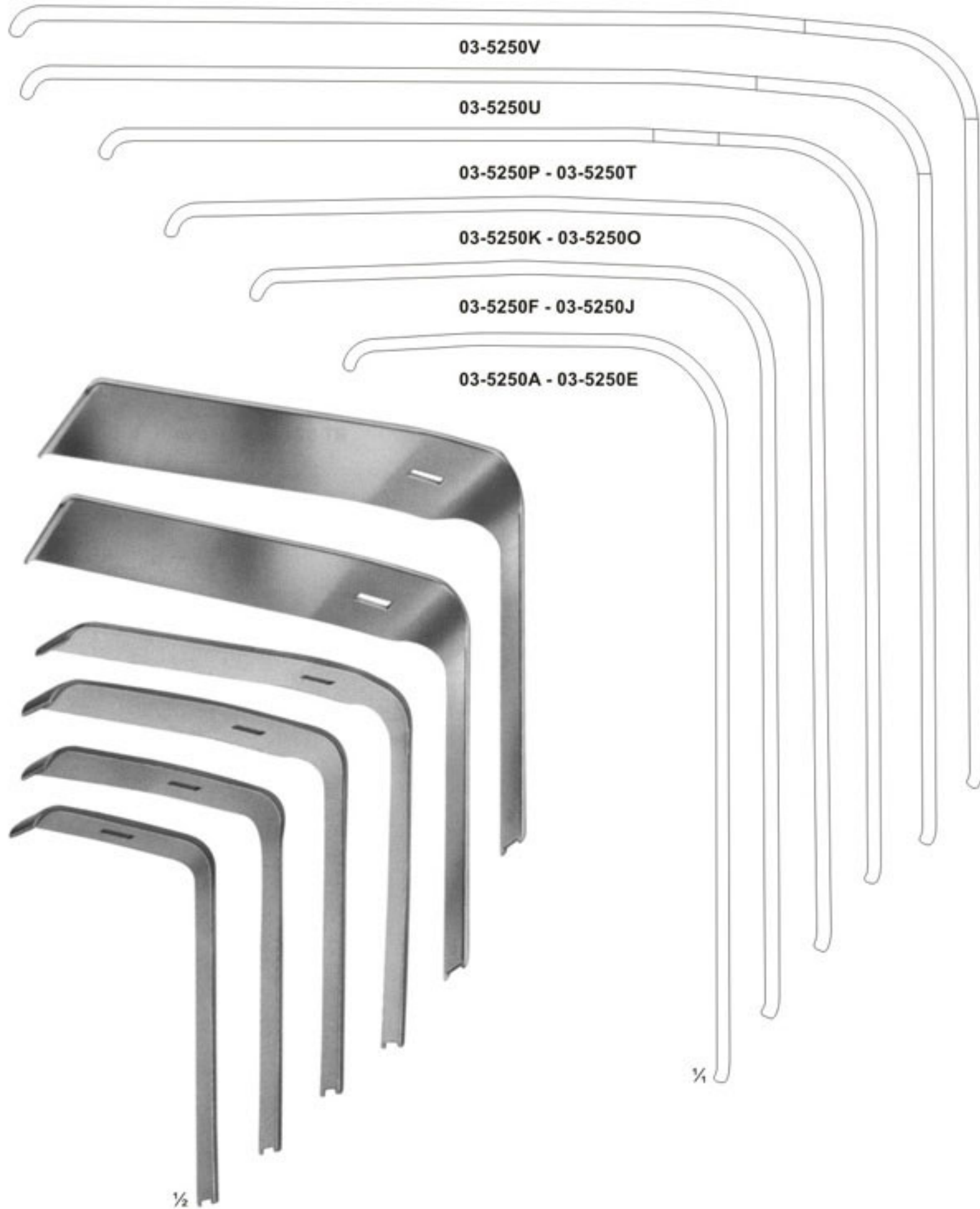

Retractor blades for handles 03-5250

Depth	Width						
	14mm	18mm	22mm	26mm	30mm	40mm	50mm
55mm	03-5250A	03-5250B	03-5250C	03-5250D	03-5250E	-	-
75mm	03-5250F	03-5250G	03-5250H	03-5250I	03-5250J	-	-
95mm	03-5250K	03-5250L	03-5250M	03-5250N	03-5250O	-	-
115mm	03-5250P	03-5250Q	03-5250R	03-5250S	03-5250T	-	-
135mm	-	-	-	-	-	03-5250U	-
145mm	-	-	-	-	-	-	03-5250V



Retractors, Vario Retractor System, Germ. Fed. Patent, Germ. Fed. Regd.Des, US-Patent.



- 03-5251 - 03-5257  
BRUNNER  
275 mm
- |         |          |
|---------|----------|
| 03-5251 | 80 x 20  |
| 03-5252 | 100 x 25 |
| 03-5253 | 120 x 25 |
| 03-5254 | 130 x 30 |
| 03-5255 | 140 x 30 |
| 03-5256 | 160 x 30 |
| 03-5257 | 180 x 30 |



03-5258  
Handle with cold light carrier for retractor blades. 280 mm

Handle arrangement variable





# Retractors, Lung Spatulas

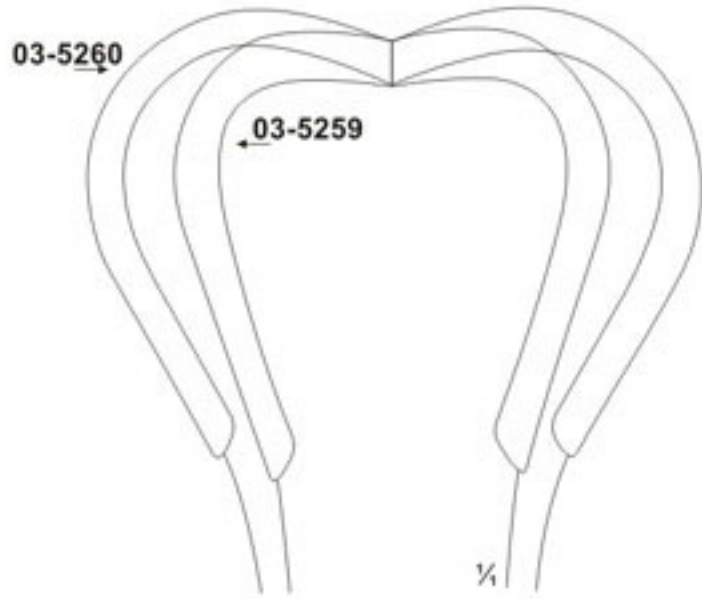

**03-5259 - 03-5260**  
HARRINGTON  
03-5259 123 x 45 mm  
03-5260 123 x 64 mm  
Flexible  
295 mm



**03-5261**  
ALLISON  
255 mm



**03-5262**  
ALLISON  
320 mm



# Retractors, Lung Spatulas





# Retractors, Lung Spatulas



03-5271  
DEAVER  
300 mm  
Fig. 1

03-5272  
DEAVER  
315 mm  
Fig. 2

03-5273  
DEAVER  
365 mm  
Fig. 2½



# Retractors, Lung Spatulas



**03-5274**  
DEAVER  
300 mm  
Fig. 3

**03-5275**  
DEAVER  
310 mm  
Fig. 4

**03-5276**  
DEAVER  
320 mm  
Fig. 5



# Retractors, Lung Spatulas



03-5277  
DEAVER  
310 mm  
Fig. 1



03-5278  
DEAVER  
310 mm  
Fig. 3



# Retractors, Lung Spatulas



03-5279  
DEAVER  
305 mm  
Fig. 4



03-5280  
DEAVER  
310 mm  
Fig. 5



# Retractors For Deep Surgery (Abdominal Retractors)

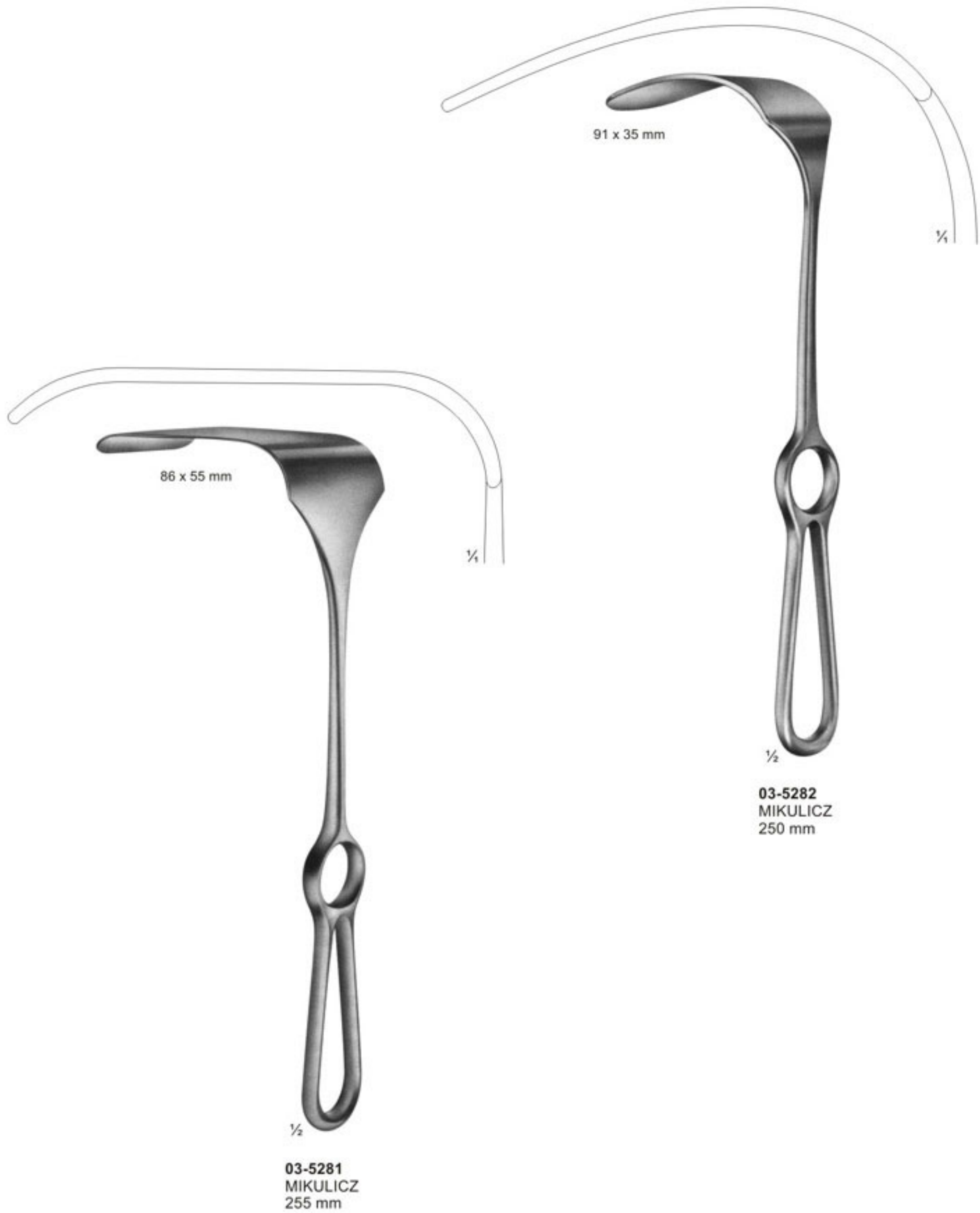



# Retractors For Deep Surgery (Abdominal Retractors)

03-5285 150 x 39 mm  
03-5286 150 x 57 mm

03-5283 121 x 50 mm  
03-5284 147 x 50 mm

1/2  
03-5285 - 03-5286  
KELLY  
03-5285 150 x 39 mm  
03-5286 150 x 57 mm  
260 mm

03-5283 - 03-5284  
MIKULICZ  
03-5283 121 x 50 mm  
03-5284 147 x 50 mm  
Liver Retractor  
250 mm

1/2





# Retractors, Abdominal Retractors



- 03-5298 Fig.1 32 x 40 mm
- 03-5299 Fig.2 34 x 50 mm
- 03-5300 Fig.3 41 x 60 mm
- 03-5301 Fig.4 46 x 75 mm
- 03-5302 Fig.5 64 x 85 mm

Length of Blades	Width of Blades		
	35mm	45mm	60mm
62mm	03-5287	03-5290	03-5294
92mm	03-5288	03-5291	03-5295
122mm	03-5289	03-5292	03-5296
160mm		03-5293	03-5297



# Abdominal Retractors



**03-5304 - 03-5308**  
**ROCHARD**  
 310 mm  
**03-5304** 48 x 90 mm  
**03-5305** 48 x 105 mm  
**03-5306** 48 x 120 mm  
**03-5307** 48 x 135 mm  
**03-5308** 48 x 155 mm



**03-5309**  
**ROCHARD**  
 Fixation device for



**03-5310 - 03-5313**  
**DOYEN**  
 280 mm  
**03-5310** 48 x 90 mm  
**03-5311** 48 x 105 mm  
**03-5312** 48 x 120 mm  
**03-5313** 48 x 135 mm



**03-5314**  
**DOYEN-CHILD**  
 Fixation device  
 220 mm



**03-5315**  
 Chain  
 with weight  
 645g  
 790 mm



# Pelvis Retractors

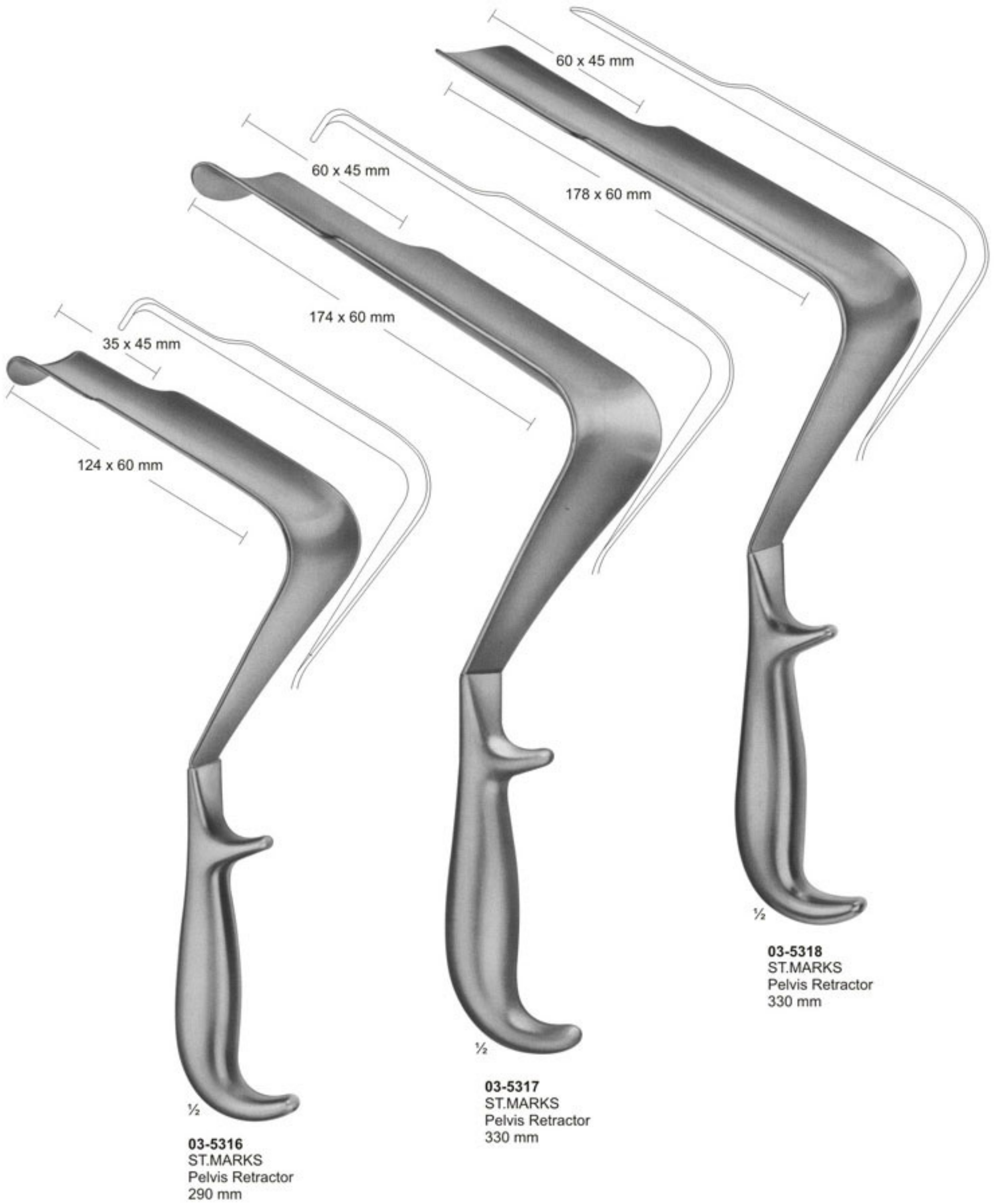

1/2  
**03-5316**  
ST.MARKS  
Pelvis Retractor  
290 mm

1/2  
**03-5317**  
ST.MARKS  
Pelvis Retractor  
330 mm

1/2  
**03-5318**  
ST.MARKS  
Pelvis Retractor  
330 mm



# Abdominal- and Intestinal Spatulas

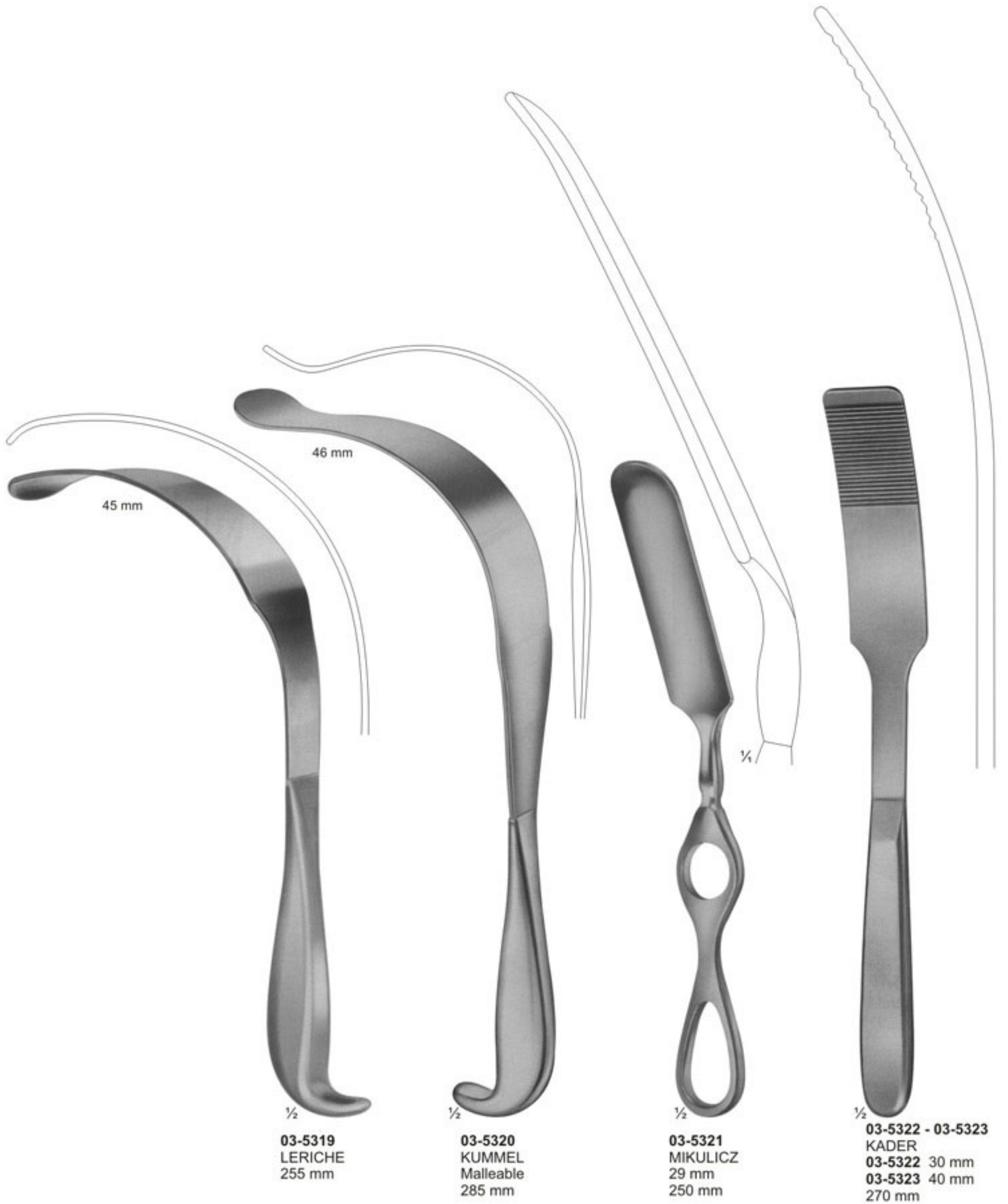

1/2  
**03-5319**  
LERICHE  
255 mm

1/2  
**03-5320**  
KUMMEL  
Malleable  
285 mm

1/2  
**03-5321**  
MIKULICZ  
29 mm  
250 mm

1/2  
**03-5322 - 03-5323**  
KADER  
**03-5322** 30 mm  
**03-5323** 40 mm  
270 mm



# Abdominal- and Intestinal Spatulas



**03-5324**  
REVERDIN  
285 mm



**03-5325**  
HABERER  
Malleable  
305 mm



**03-5326 - 03-5328**  
03-5326 30 mm  
03-5327 40 mm  
03-5328 50 mm  
Malleable  
330 mm



**03-5329**  
TUFFIER  
Malleable  
200 mm



# Self-Retaining Retractors



**03-5330**  
BOSE  
60 mm



**03-5331**  
FINSEN  
50 mm



**03-5332**  
FINSEN  
70 mm



**03-5333**  
FINSEN modif.  
75 mm



**03-5334**  
45 mm



**03-5335**  
55 mm



**03-5336**  
MUELLER  
65 mm



**03-5337**  
100 mm



**03-5338**   **03-5339**



**03-5338 - 03-5339**  
**03-5338** 70 mm  
**03-5339** 100 mm



**03-5340**  
LOGAN  
modif. REILL  
50 mm



**03-5341**  
JANSEN  
100 mm



**03-5342**  
JANSEN  
100 mm

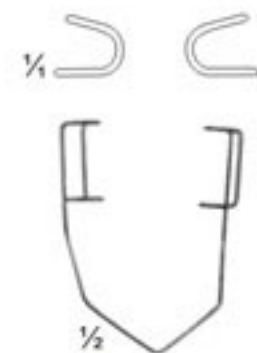

**03-5343**  
BARRAQUER  
45 mm



# Self-Retaining Retractors



**03-5344**  
WEITLANER  
Sharp  
110 mm



**03-5345**  
WEITLANER  
Semi-Sharp  
110 mm



**03-5346**  
WEITLANER  
Blunt  
110 mm



**03-5347**  
WEITLANER  
Sharp  
130 mm



**03-5348**  
WEITLANER  
Semi-Sharp  
130 mm



**03-5349**  
WEITLANER  
Blunt  
130 mm



# Self-Retaining Retractors

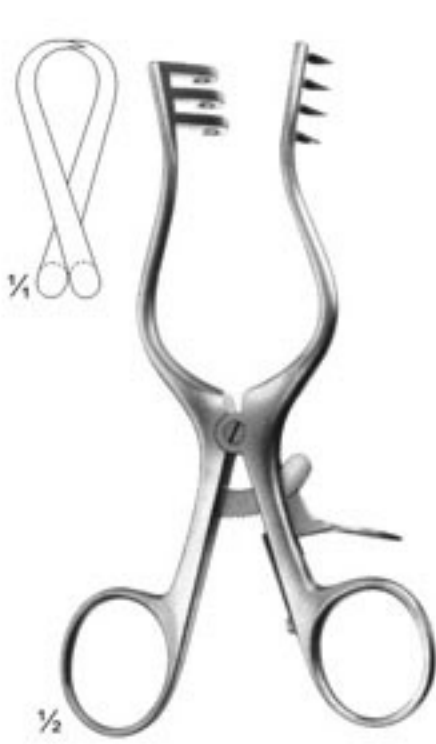

**03-5350**  
WEITLANER  
Sharp  
130 mm

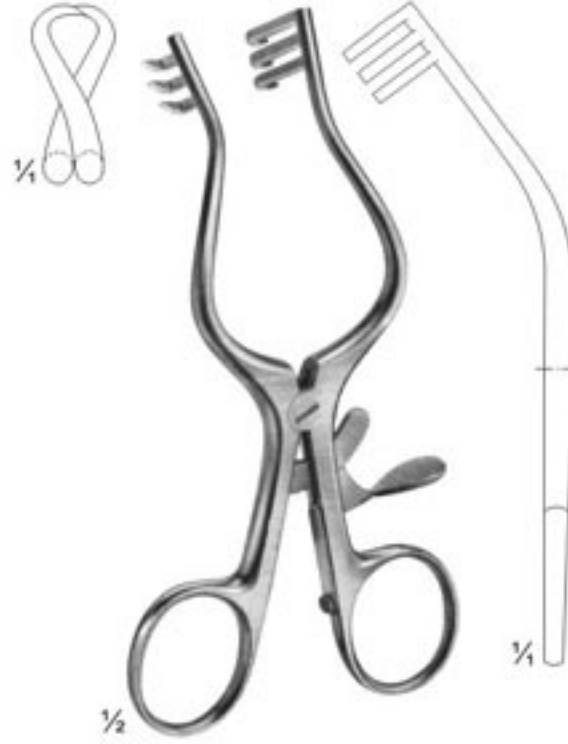

**03-5351**  
WULLSTEIN  
Sharp  
130 mm

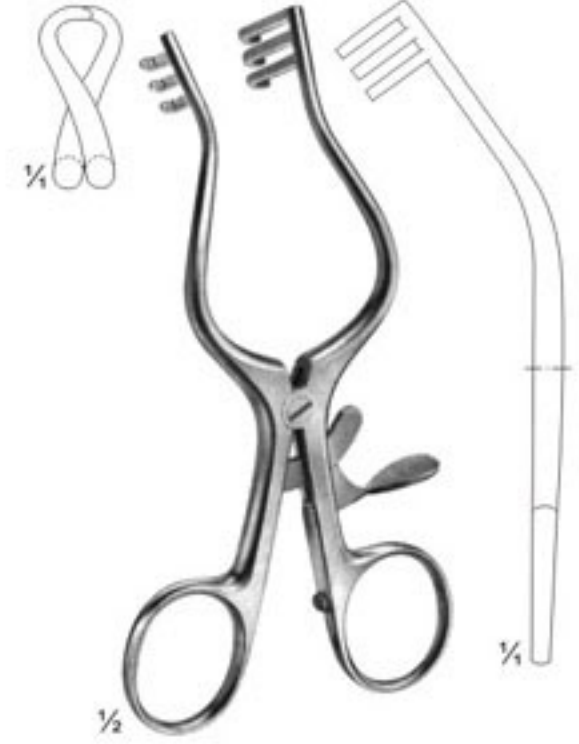

**03-5352**  
WULLSTEIN  
Blunt  
130 mm



**03-5353**  
WEITLANER  
Sharp  
165 mm



**03-5354**  
PLESTER  
Blunt  
110 mm

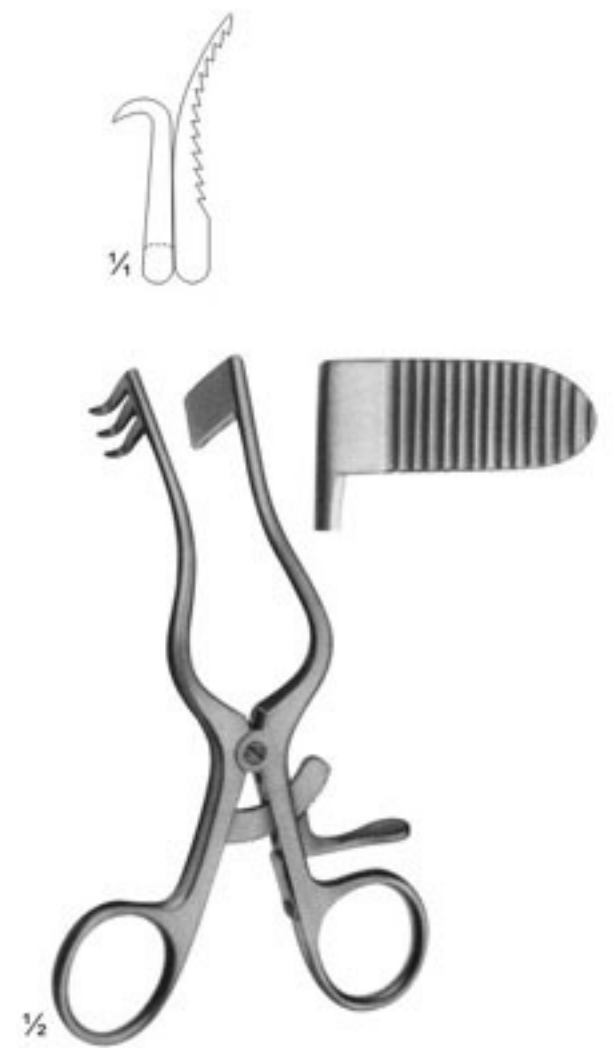

**03-5355**  
PERKINS  
130 mm





# Self-Retaining Retractors



**03-5356**  
ADSON-BABY  
Blunt  
140 mm



**03-5357**  
MOLLISON  
Sharp  
155 mm



**03-5358**  
MAYO-ADAMS  
165 mm



# Self-Retaining Laminectomy Retractors



**03-5359**  
ANDERSON-ADSON  
Sharp  
190 mm



**03-5360**  
NORFOLK and  
NORWICH  
Blunt  
220 mm



**03-5361**  
ADSON  
Sharp  
265 mm



# Self-Retaining Laminectomy Retractors

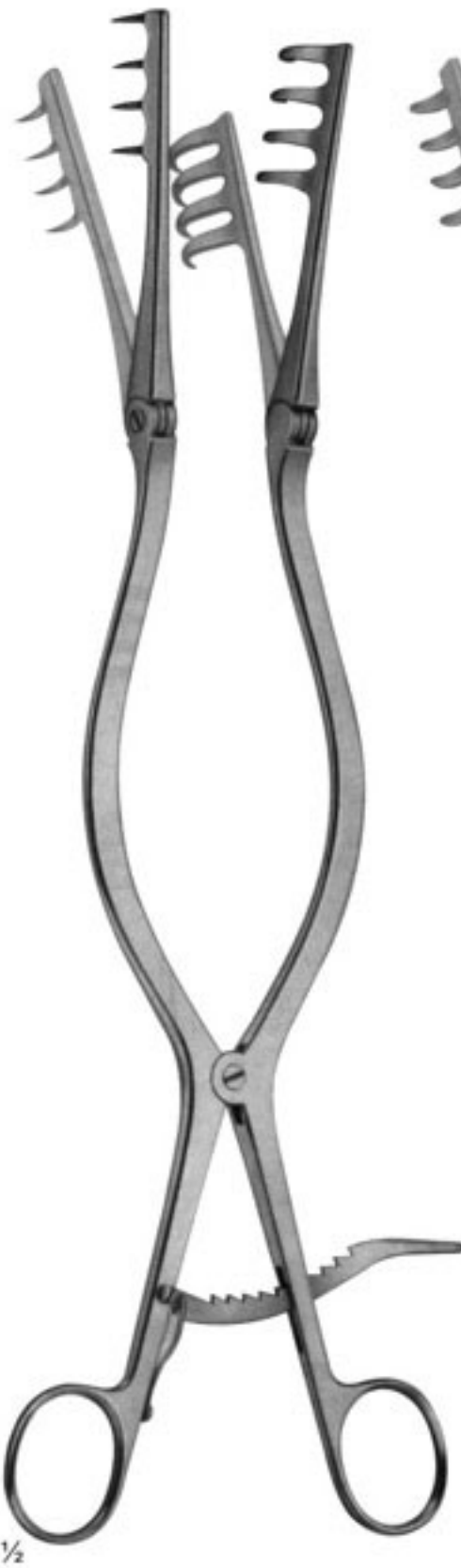
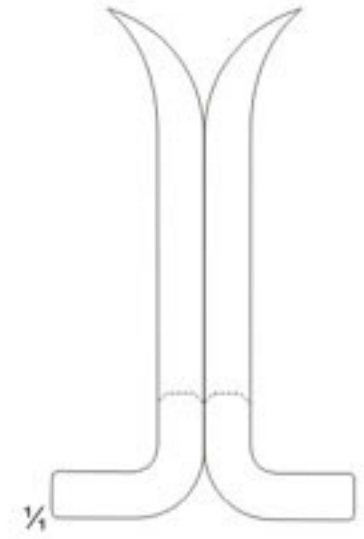
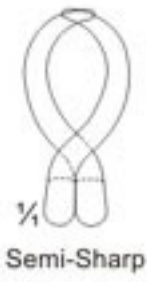

03-5363  
BECKMANN-ADSON  
Semi-Sharp  
310 mm



03-5364  
ADSON  
Semi-Sharp  
320 mm



03-5365  
BECKMANN-EATON  
Sharp  
320 mm

03-5362 - 03-5363  
BECKMANN-ADSON  
Sharp  
310 mm



# Special Retractors



**03-5366**  
JOLL ( FRIEDMAN )  
Thyroid- and Vaginal Retractor  
155 mm

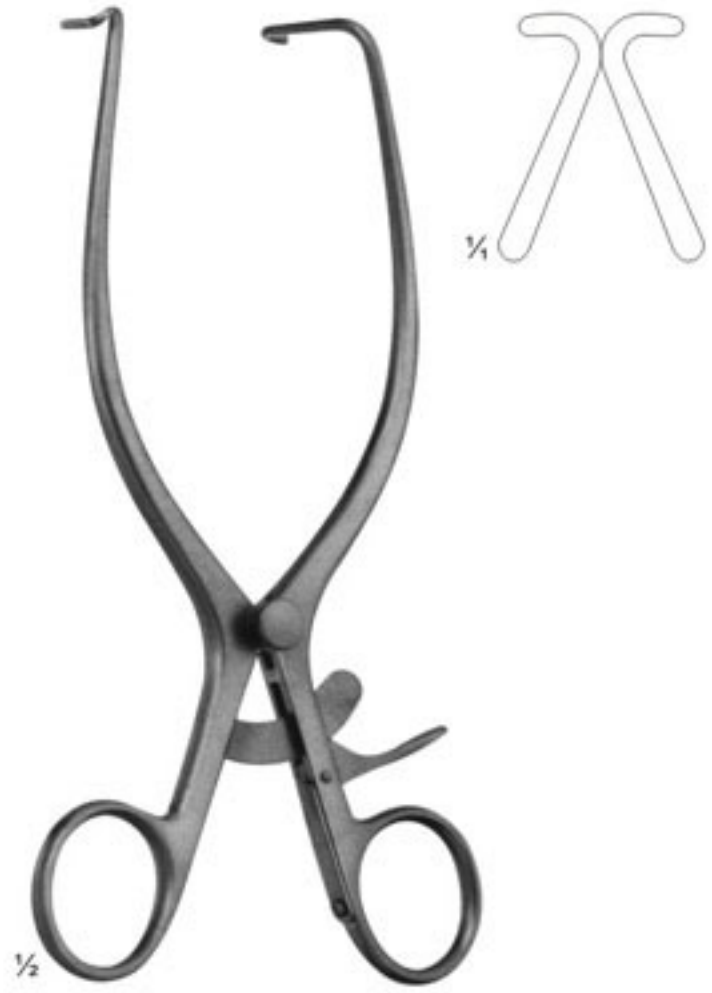

**03-5367**  
JACKSON BURROWS  
Retractor, blunt  
185 mm



**03-5368**  
GELPI  
Vaginal Retractor  
135 mm

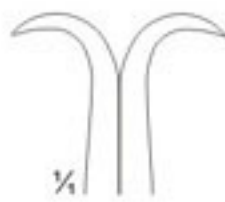

**03-5369**  
GELPI  
Skin- and Vaginal Retractor  
175 mm

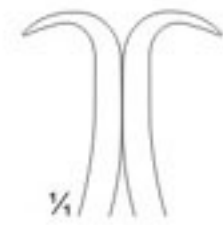

**03-5370**  
DE BAKEY  
Femur Retractor  
145 mm



# Self Retaining Retractors for Laminectomy and other Operations



**03-5371**  
**SCOVILLE-RICHTER**  
 Retractor with 1 pair  
 blades reversible type.  
 The Retractor bar and shanks  
 may be easily rotated 180° when  
 blades are in situ.



**03-5372**  
 62 x 52 mm  
 PR= Pair

**03-5373**  
 62 x 37 mm



**03-5373**  
 47 x 51 mm



**03-5374**  
 30 x 40 mm



**03-5375**  
 37 x 62 mm



# Retractors for Cervical Spine



- 03-5376**  
CLOWARD modif.  
Spreader Only  
Consisting of:  
Spreader Only  
**03-5377** 1 Blade  
**03-5378** 1 Blade  
**03-5379** 1 Blade  
**03-5380** 1 Blade  
**03-5381** 1 Blade

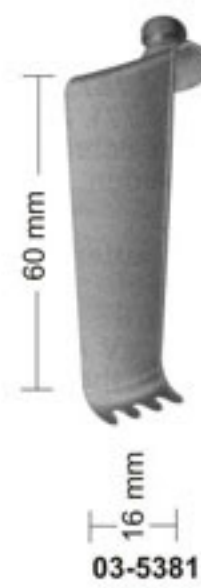
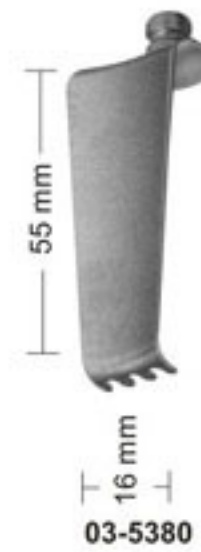
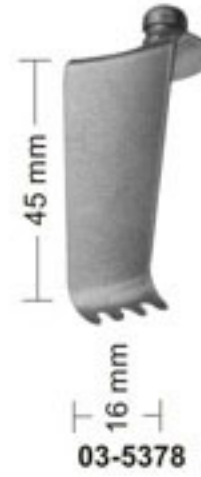

Blades only used for **03-5376**



# Retractors for Cervical Vertebral Column

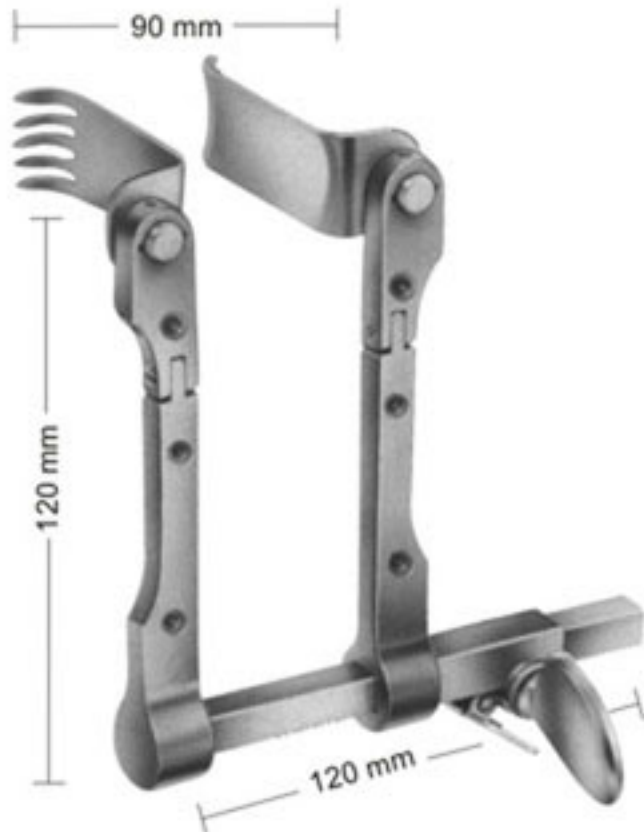

**03-5387**  
CASPAR  
Retractor, adjustable, consisting of:  
5 medial blades (03-5389 - 03-5393) 5 Lateral  
blades. (03-5394 - 03-5398) and the retractor  
only By Reversing the Screw,  
The Retractor Can be Used From Both Sides

To be used preferably for transverse retraction.



**03-5388**  
CASPAR  
Counter retractor, adjustable,  
consisting of: 5 blades. (03-5399 - 03-5403)  
and the retractor only

To be used preferably for up and down retraction.



- |                           |                           |                           |                           |  |   |
|---------------------------|---------------------------|---------------------------|---------------------------|--|---|
| <b>03-5389</b> 40 x 23 mm | <b>03-5394</b> 40 x 23 mm | <b>03-5399</b> 45 x 23 mm | <b>03-5404</b> 50 x 25 mm | <b>03-5406</b> 40 x 25 mm                        | <b>03-5411</b> 40 x 25 mm                         |
| <b>03-5390</b> 45 x 23 mm | <b>03-5395</b> 45 x 23 mm | <b>03-5400</b> 50 x 23 mm | <b>03-5405</b> 60 x 25 mm | <b>03-5407</b> 45 x 25 mm                        | <b>03-5412</b> 45 x 25 mm                         |
| <b>03-5391</b> 50 x 23 mm | <b>03-5396</b> 50 x 23 mm | <b>03-5401</b> 55 x 23 mm | Blunt blades,             | <b>03-5408</b> 50 x 25 mm                        | <b>03-5413</b> 50 x 25 mm                         |
| <b>03-5392</b> 55 x 23 mm | <b>03-5397</b> 55 x 23 mm | <b>03-5402</b> 60 x 23 mm | for harvesting of the     | <b>03-5409</b> 55 x 25 mm                        | <b>03-5414</b> 55 x 25 mm                         |
| <b>03-5393</b> 60 x 23 mm | <b>03-5398</b> 60 x 23 mm | <b>03-5403</b> 65 x 23 mm | fusion graft from the     | <b>03-5410</b> 60 x 25 mm                        | <b>03-5415</b> 60 x 25 mm                         |
| Medial blades             | Lateral blades            | Blunt blades              | iliac crest               | Medial Titan blades<br>semi transparent to x-ray | Lateral Titan blades<br>semi transparent to x-ray |



# Lamina Spreaders



**03-5416**  
CLOWARD  
155 mm



**03-5417**  
CLOWARD  
135 mm



**03-5418**  
INGE  
170 mm

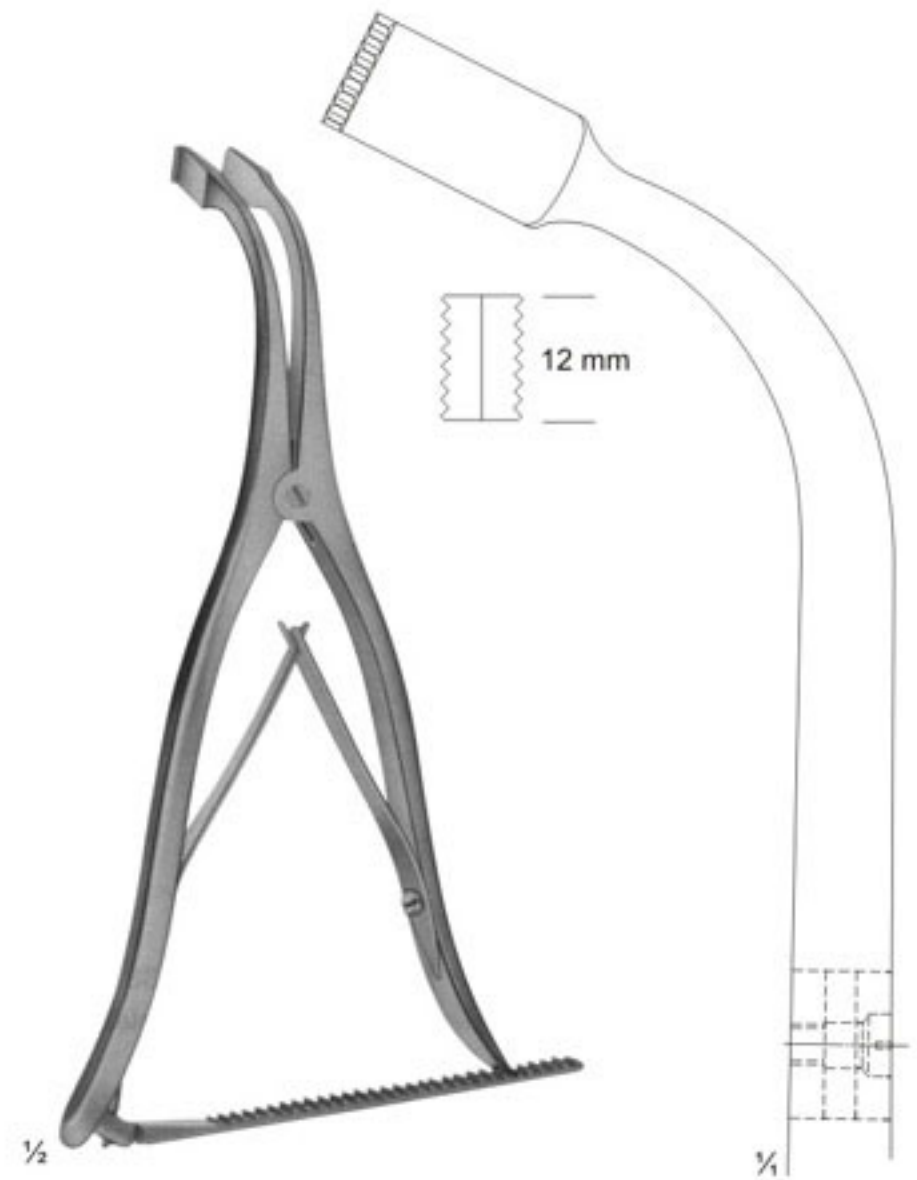

**03-5419**  
INGE  
275 mm





# Abdominal Retractors



**03-5420**  
BABY-COLLIN  
with 2 pair of blades



**03-5421**  
COLLIN  
complete



**03-5422**  
COLLIN  
complete



**03-5423**  
RICARD  
complete  
Spreader only  
Lateral blade  
Center blade



**03-5424**  
HOLZBACH  
Complete  
Spreader only  
Lateral blade 59x80mm  
Center blade 74x82mm



# Abdominal Baldes



03-5427

Lateral blades only  
03-5425 37x62 mm  
03-5426 37x80 mm  
03-5427 37x98 mm

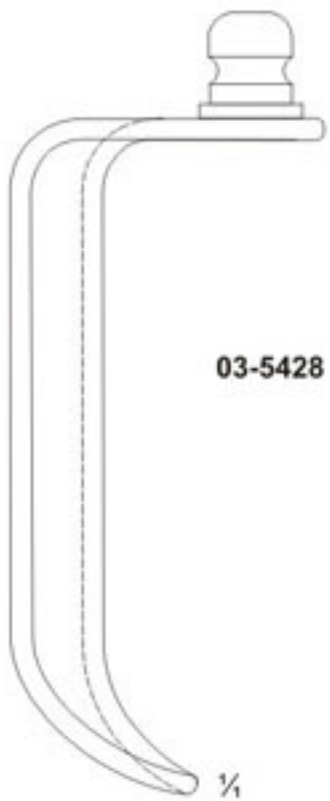

03-5428

03-5428 61x80 mm

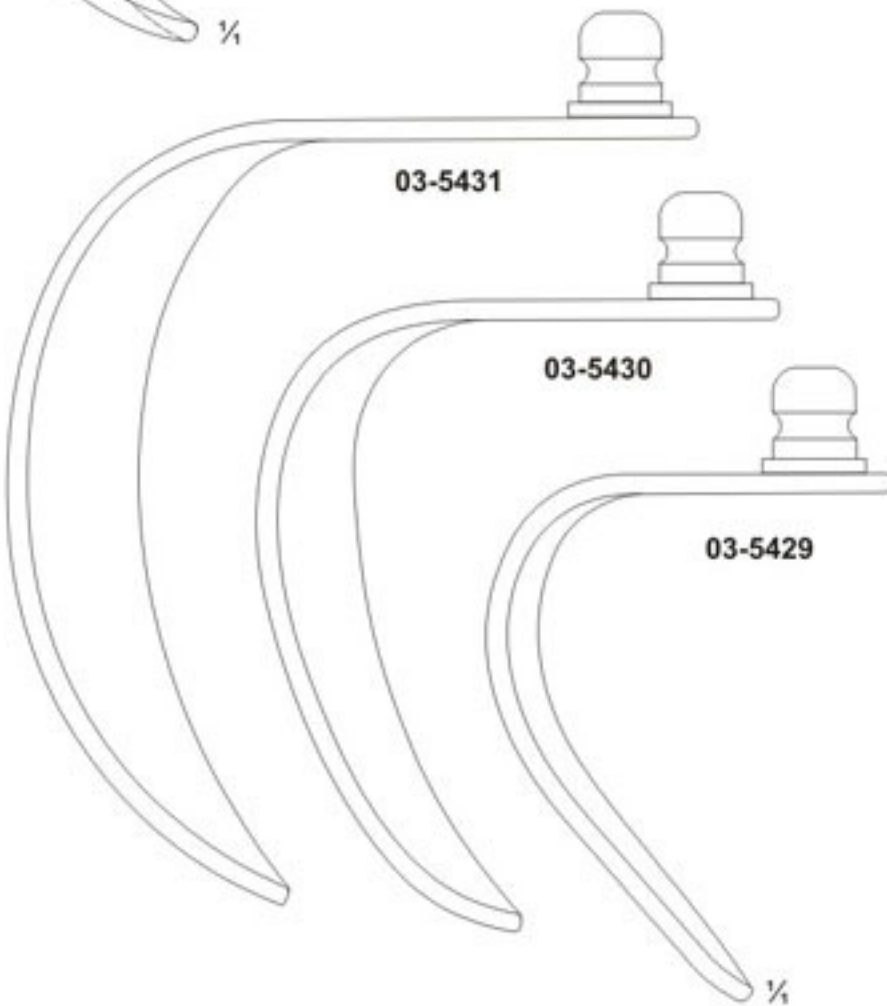

03-5431

03-5430

03-5429

03-5429 48x59 mm  
03-5430 58x80 mm  
03-5431 72x84 mm



03-5432 59x80 mm





# Abdominal Retractors



**03-5433**  
GOSSET  
Blades:38 mm deep

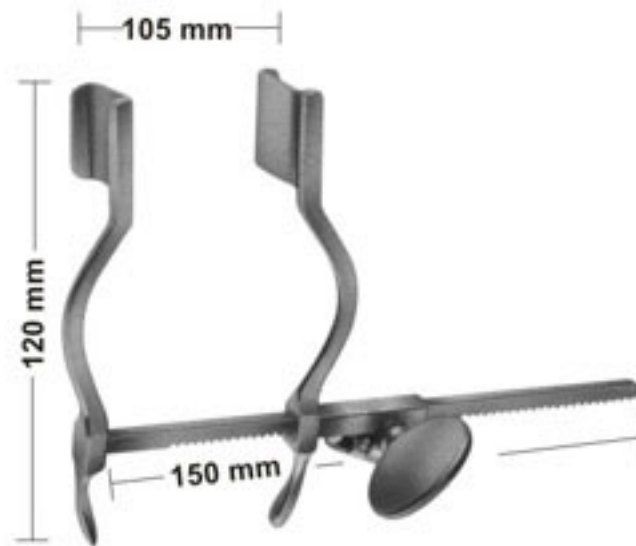

**03-5434**  
HERTZLER  
Blades 20 X 25 mm

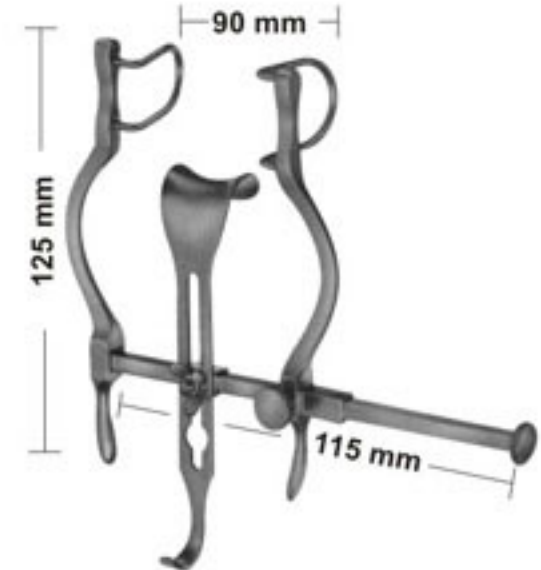

**03-5435**  
BALFOUR-BABY  
Lateral blades 27 mm deep  
(03-5435) Center blade 21x24 mm

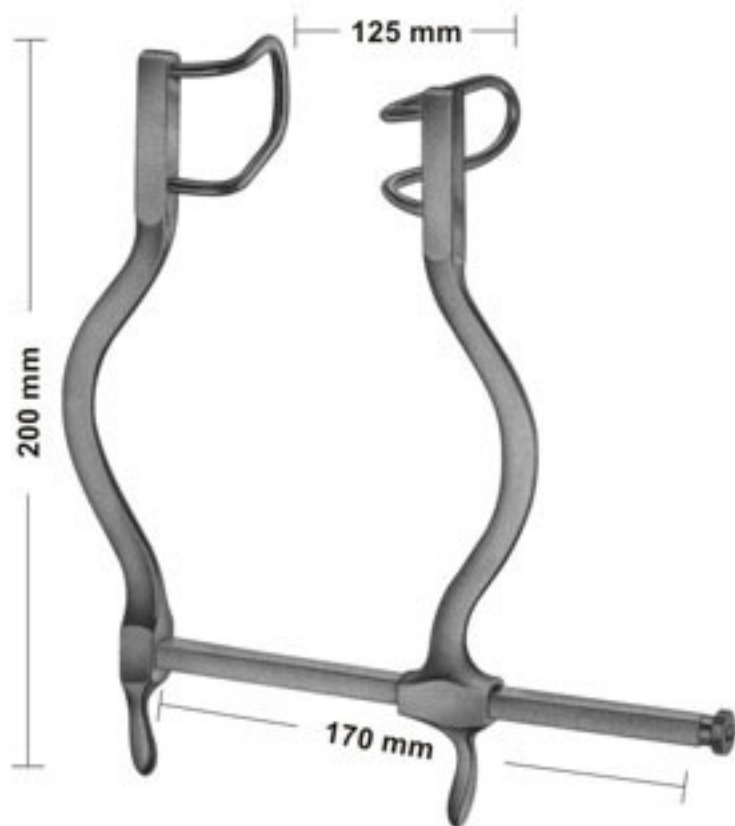

**03-5436**  
GOSSET  
Blades:55mm deep

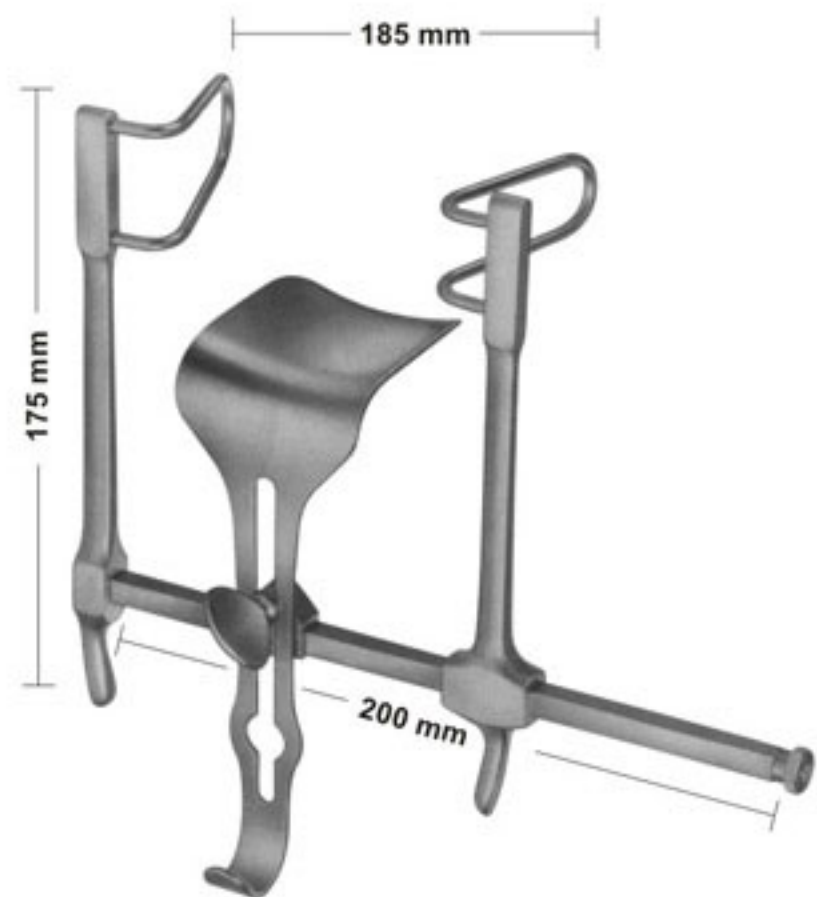

**03-5437**  
GOSSET  
Lateral blades 58 mm deep  
Center blade  
59 x 57 mm



# Abdominal Retractors

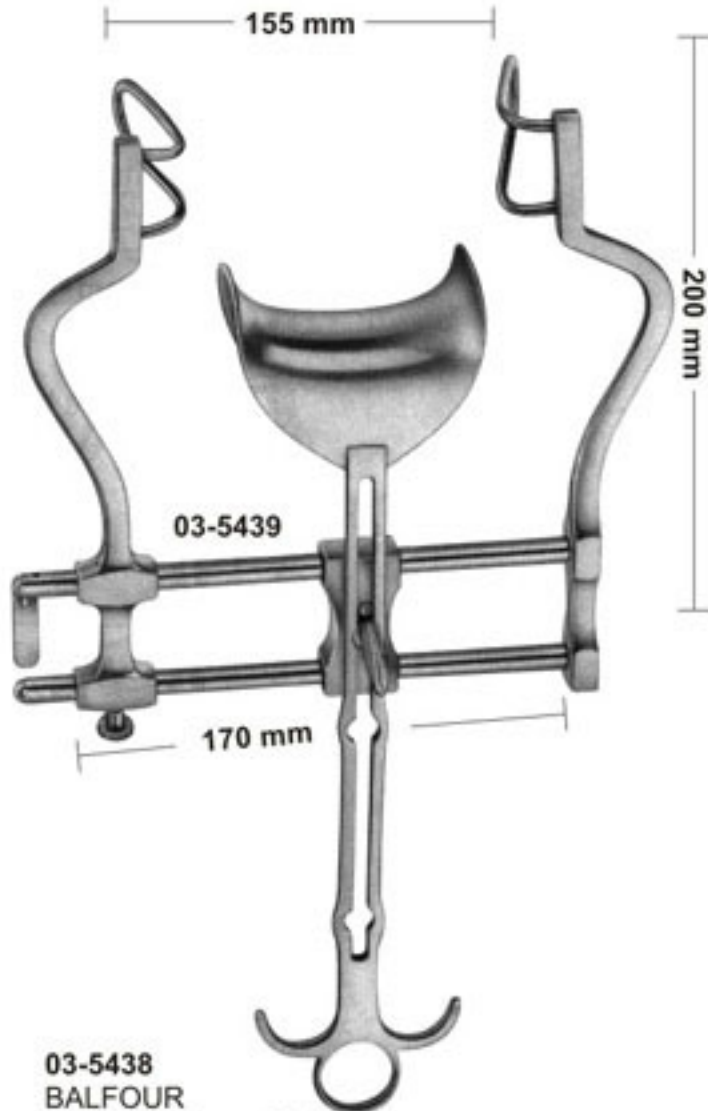

**03-5438**  
BALFOUR  
Lateral blades 60 mm deep  
(03-5439) Center blade  
47 x 80 mm

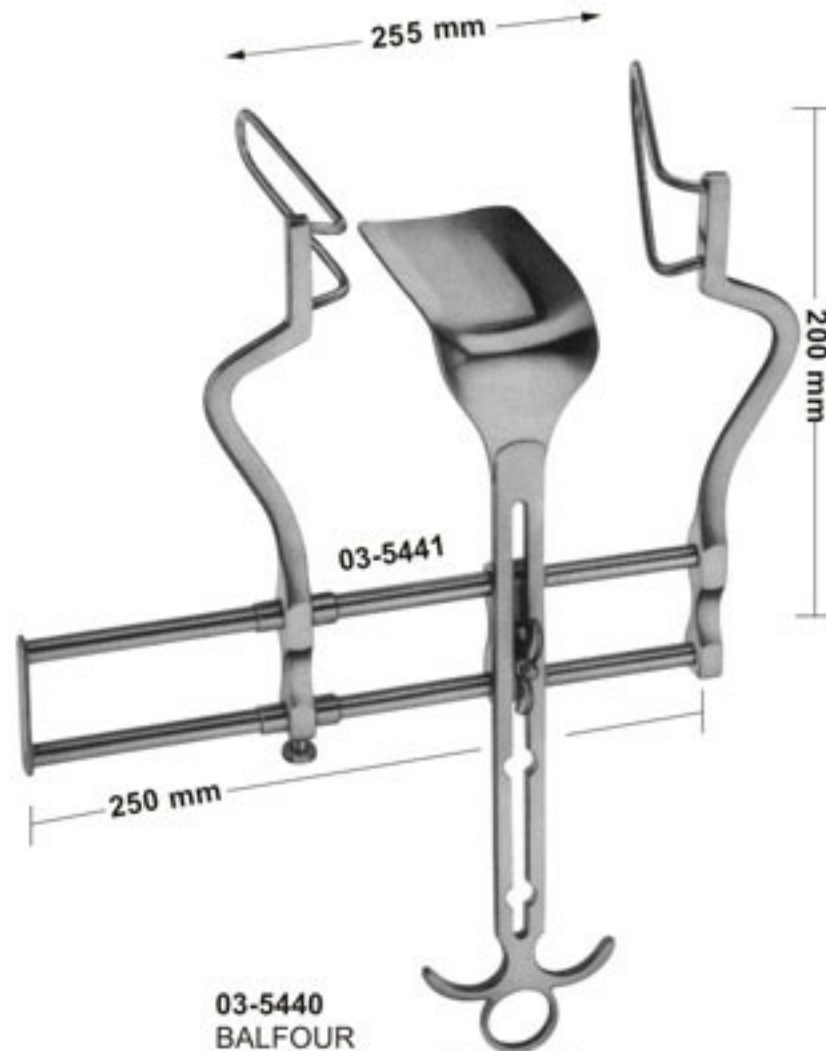

**03-5440**  
BALFOUR  
Lateral blades 105 mm deep  
(03-5441) Center blade  
107x 59 mm



**03-5442**  
Center blade only  
54x80 mm

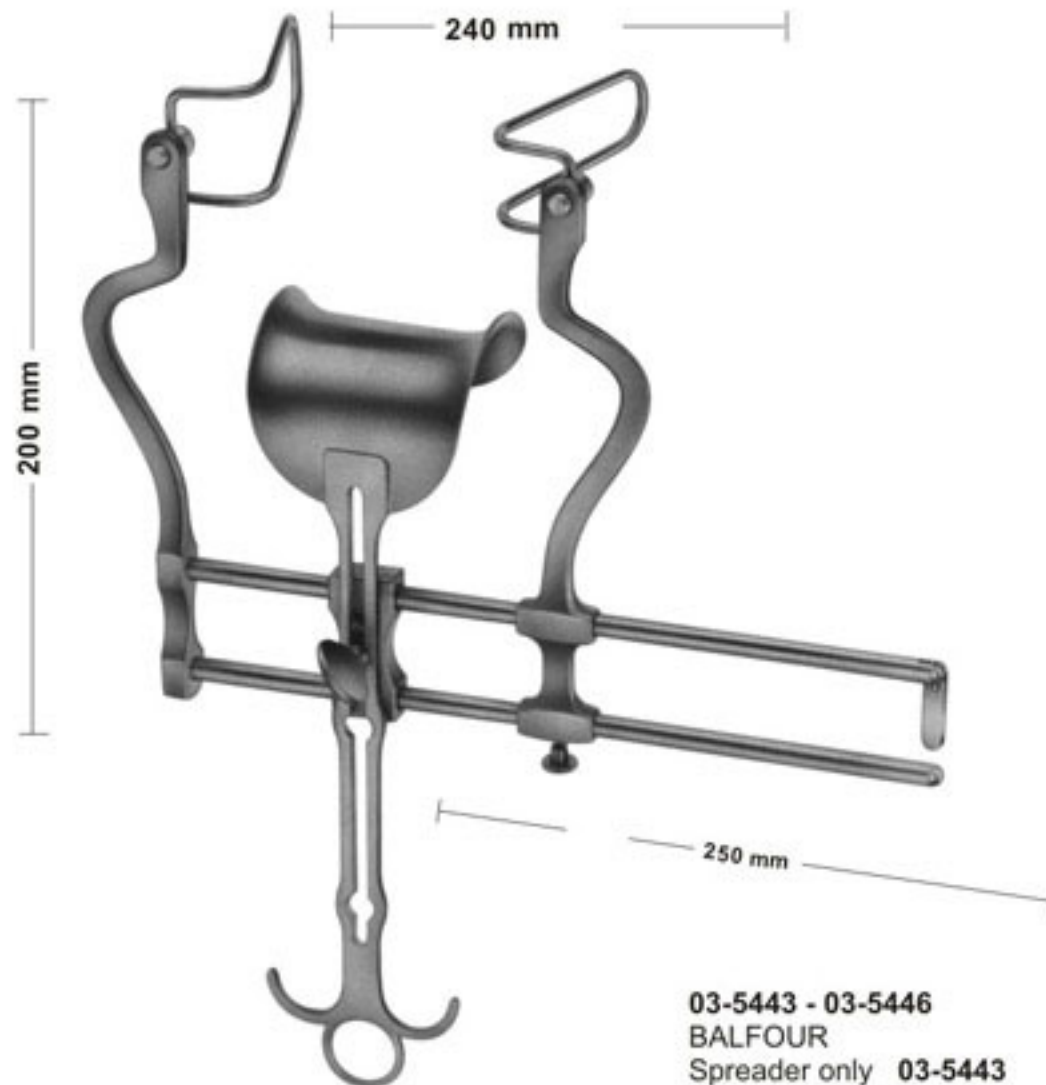

**03-5443 - 03-5446**  
BALFOUR

Spreader only	<b>03-5443</b>	<b>03-5444</b>	<b>03-5445</b>	<b>03-5446</b>
Lateral blades	50 mm	60 mm	75 mm	90 mm
Center blade	47 x 80 mm	62x76 mm	80x80 mm	80x80 mm



Sales Unit of blades:PR = pair

- Lateral blades
- 03-5447** 50 mm deep
- 03-5448** 60 mm deep
- 03-5449** 75 mm deep
- 03-5450** 90 mm deep



# Abdominal Retractors

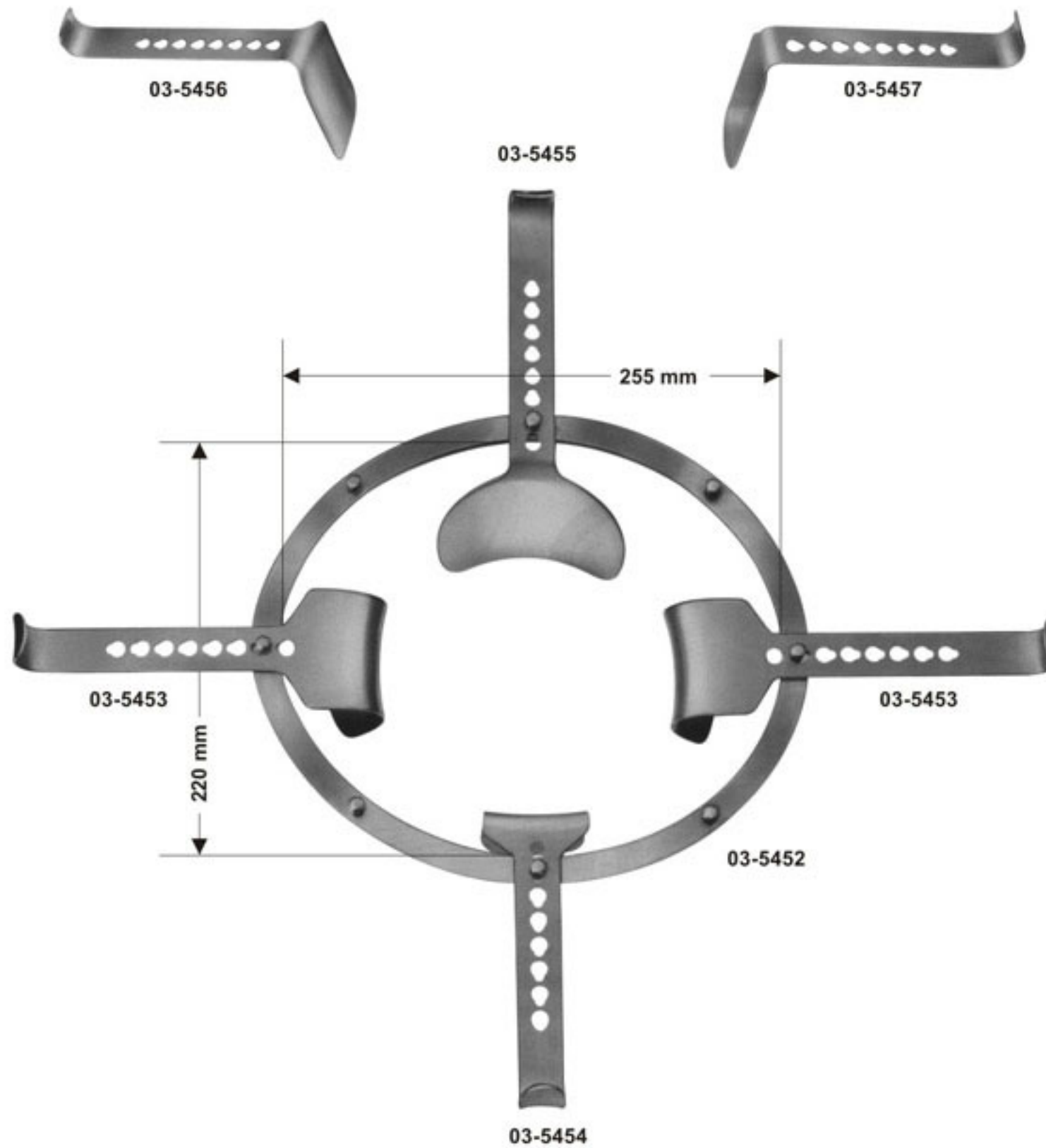

- 03-5451**  
SEMM  
consisting of:
- 03-5452** 1 frame 225 x 220 mm
  - 03-5453** 2 blades 46 x 64 mm
  - 03-5454** 1 blade 53 x 54 mm  
(for bladder)
  - 03-5455** 1 blade 82 x 97 mm  
(for intestine)
  - 03-5456** 1 blade 98 x 51 mm  
(for intestine)
  - 03-5457** 1 blade, narrow  
107 x 36 mm



# Abdominal Retractors

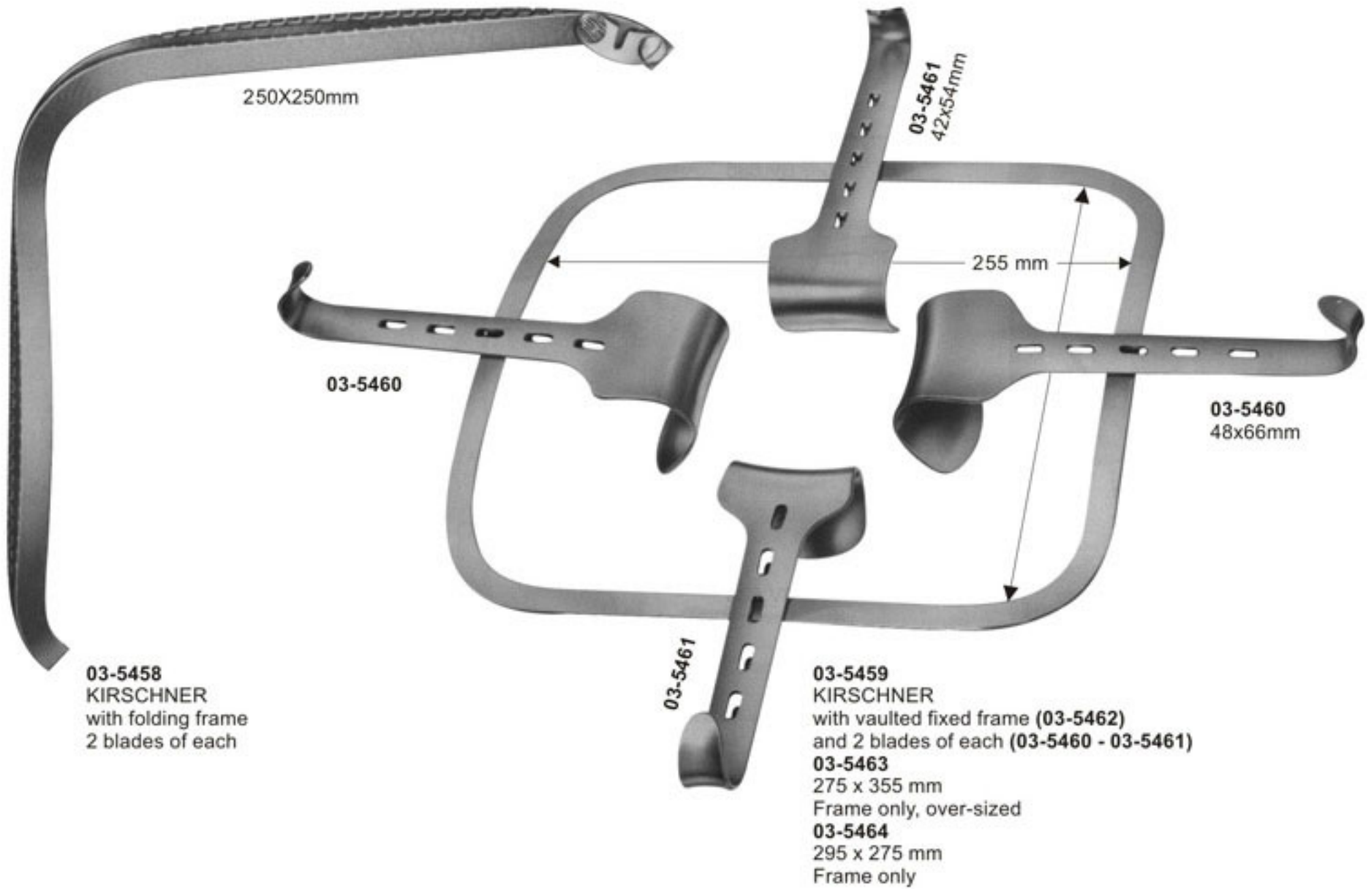

**03-5458**  
KIRSCHNER  
with folding frame  
2 blades of each

**03-5459**  
KIRSCHNER  
with vaulted fixed frame (03-5462)  
and 2 blades of each (03-5460 - 03-5461)  
**03-5463**  
275 x 355 mm  
Frame only, over-sized  
**03-5464**  
295 x 275 mm  
Frame only



**03-5465**  
KIRSCHNER  
64 x 80 mm



**03-5466**  
KIRSCHNER-BALFOUR  
80x 82 mm



**03-5467 - 03-5469**  
KIRSCHNER  
**03-5467** 90x 69mm  
**03-5468** 92x 95mm  
**03-5469** 78x 58mm



**03-5470 - 03-5472**  
KIRSCHNER  
**03-5470** 108x42mm  
**03-5471** 91x 55mm  
**03-5472** 121x 55mm

Addition valves for corpulent persons.