

# Section - 05



**Pages 255-318**

- ★ Tracheotomy, Cardiovascular & Thoracic Surgery
- ★ Bone Punches & Rongeurs





# Tracheal Tubes with inner tubes

Fig.	0	1	2	3	4	5	6	7	8	9	10
$\varnothing$ mm	4	5	6	7	8	9	10	11	12	13	14
Charr./Fr.	12	15	18	21	24	27	30	33	36	39	42



1/2

**05-7001**  
UECKERMANN-DENKER  
Crycothyrotomy trocar  
with silver cannula  
130mm

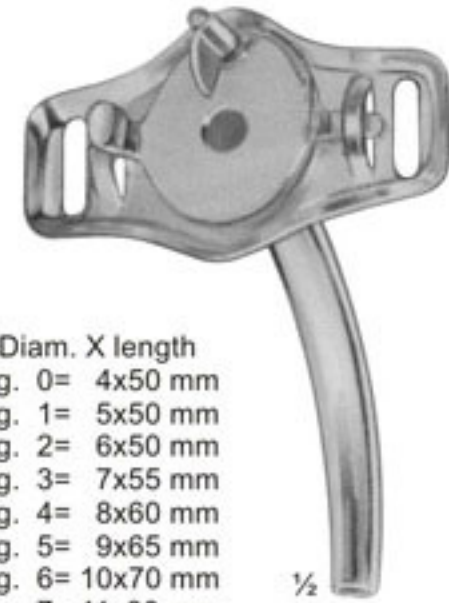

1/2

Diam. X length  
**05-7002** Fig. 0= 4x50 mm  
**05-7003** Fig. 1= 5x50 mm  
**05-7004** Fig. 2= 6x50 mm  
**05-7005** Fig. 3= 7x55 mm  
**05-7006** Fig. 4= 8x60 mm  
**05-7007** Fig. 5= 9x65 mm  
**05-7008** Fig. 6= 10x70 mm  
**05-7009** Fig. 7= 11x80 mm  
**05-7010** Fig. 8= 12x85 mm  
**05-7011** Fig. 9= 13x90 mm  
**05-7012** Fig. 10=14x90 mm

**05-7002 - 05-7012**  
LUER  
German silver



1/2

**05-7013 - 05-7022**  
JACKSON  
German Silver

Diam. X length  
**05-7013** Fig. 0= 4x50 mm  
**05-7014** Fig. 1= 5x48 mm  
**05-7015** Fig. 2= 6x58 mm  
**05-7016** Fig. 3= 7x70 mm  
**05-7017** Fig. 4= 8x78 mm  
**05-7018** Fig. 5= 9x84 mm  
**05-7019** Fig. 6= 10x84 mm  
**05-7020** Fig. 7= 11x86 mm  
**05-7021** Fig. 8= 12x88 mm  
**05-7022** Fig. 9= 13x90 mm



1/2

Diam. X length **05-7023 - 05-7032**  
**05-7023** Fig. 1= 5x48 mm JACKSON  
**05-7024** Fig. 2= 6x58 mm Stainless Steel  
**05-7025** Fig. 3= 7x70 mm  
**05-7026** Fig. 4= 8x78 mm  
**05-7027** Fig. 5= 9x84 mm  
**05-7028** Fig. 6= 10x84 mm  
**05-7029** Fig. 7= 11x86 mm  
**05-7030** Fig. 8= 12x88 mm  
**05-7031** Fig. 9= 13x90 mm  
**05-7032** Fig.10= 14x90 mm



# Wound-and Tracheal Hooks and Dilators

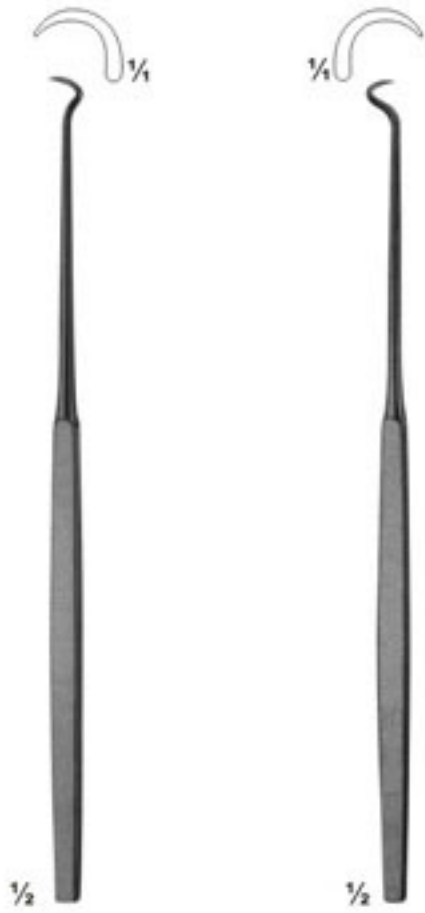

**05-7033**  
BOSE  
165 mm

**05-7034**  
BOSE  
165 mm



**05-7035**  
sharp

**05-7036**  
blunt

**05-7037**  
blunt

**05-7035 - 05-7037**  
180 mm

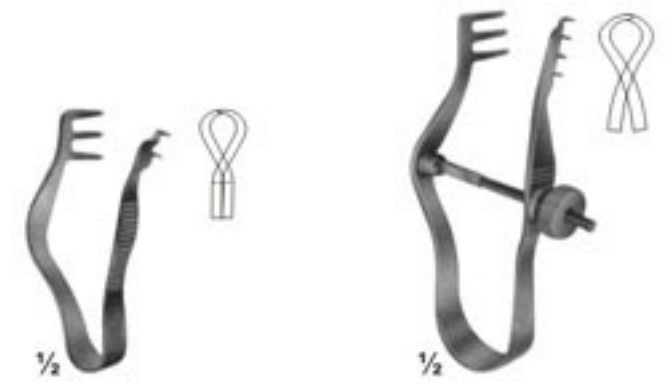

**05-7038**  
FINZEN  
50 mm

**05-7039**  
FINZEN  
70 mm



**05-7040**  
TROUSSEAU  
120 mm



**05-7041**  
LABORDE  
125 mm



**05-7042**  
LABORDE  
strong pattern  
135 mm



**05-7043**  
Cleaning Brush  
for tracheal tubes  
285 mm





# Irrigating Cannulae, Embolus Grasping Forceps, Dilators

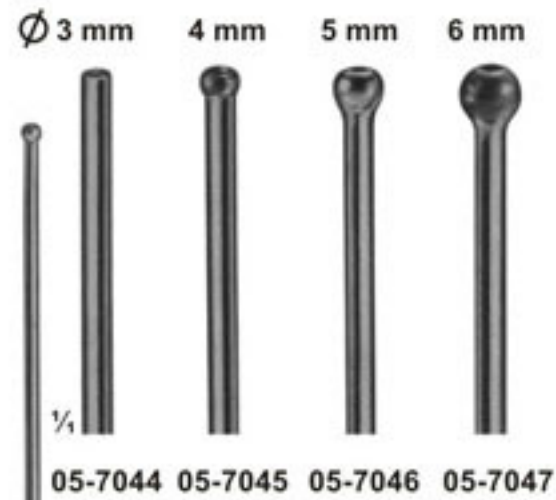

Luer Lock  
1/4

**05-7044 - 05-7047**  
SCHMID  
Vessel irrigating cannulae,  
malleable, silver plated  
150 mm



**05-7048**  
BLAKE  
Embolus grasping  
forceps  
205 mm

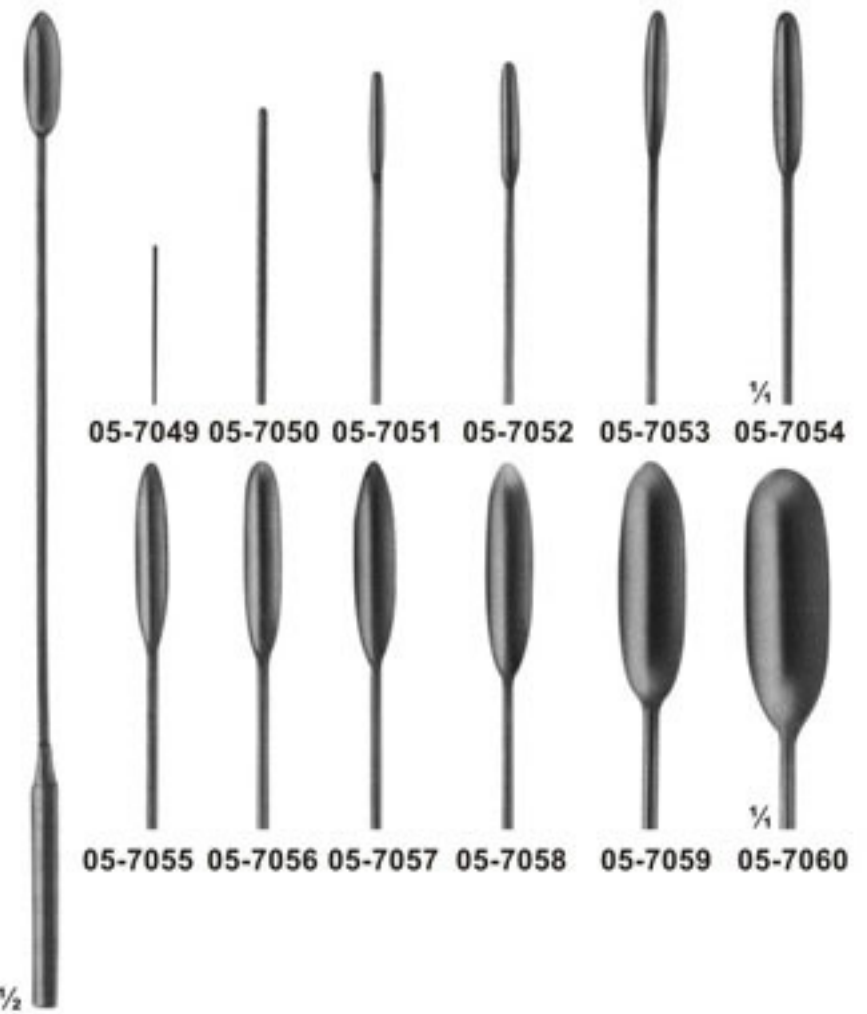

**05-7049 - 05-7060**  
DE BAKEY  
Vascular dilators,  
malleable  
190 mm

<b>05-7049</b>	0,5 mm Ø	<b>05-7055</b>	3,5 mm Ø
<b>05-7050</b>	1,0 mm Ø	<b>05-7056</b>	4,0 mm Ø
<b>05-7051</b>	1,5 mm Ø	<b>05-7057</b>	4,5 mm Ø
<b>05-7052</b>	2,0 mm Ø	<b>05-7058</b>	5,0 mm Ø
<b>05-7053</b>	2,5 mm Ø	<b>05-7059</b>	7,0 mm Ø
<b>05-7054</b>	3,0 mm Ø	<b>05-7060</b>	9,0 mm Ø





# Vascular Spatulas

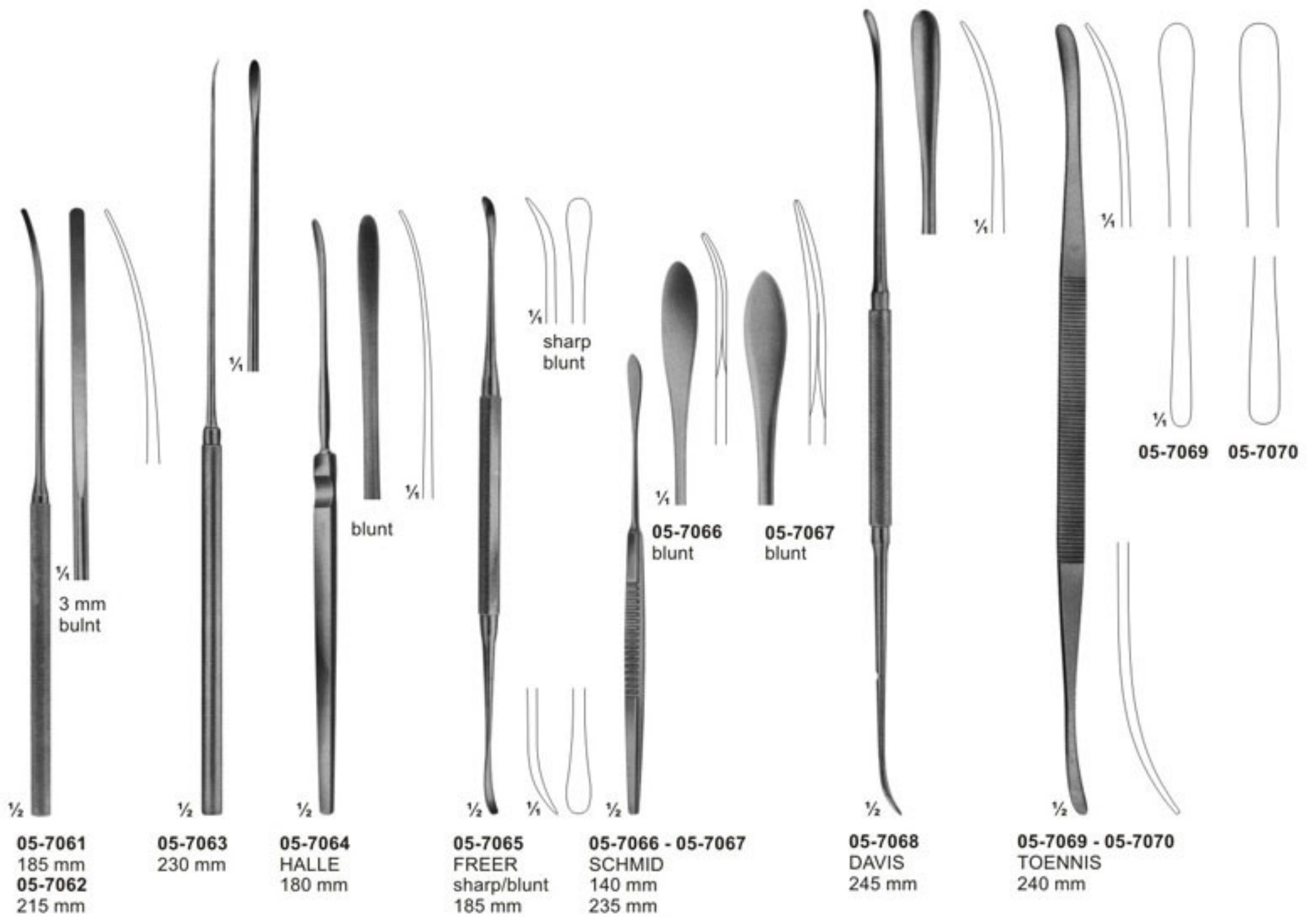





# Endarterectomy Strippers, Tourniquets

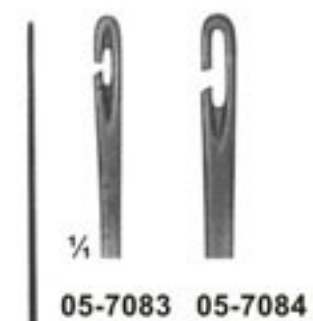
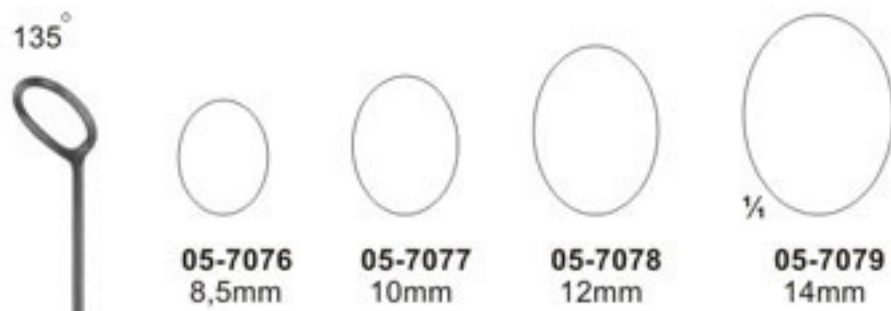
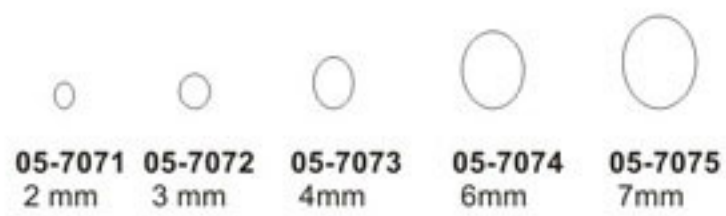

1/2  
05-7071 - 05-7079  
Endarterectomy strippers  
550 mm

1/2  
05-7080  
Handle for  
110 mm



05-7081 - 05-7082  
RUMEL-BELMONT  
325 mm  
05-7081 - 4,0 mm  $\phi$   
05-7082 - 6,4 mm  $\phi$



05-7083 - 05-7084  
Guide only





# Bioptome and Aortic Dilators

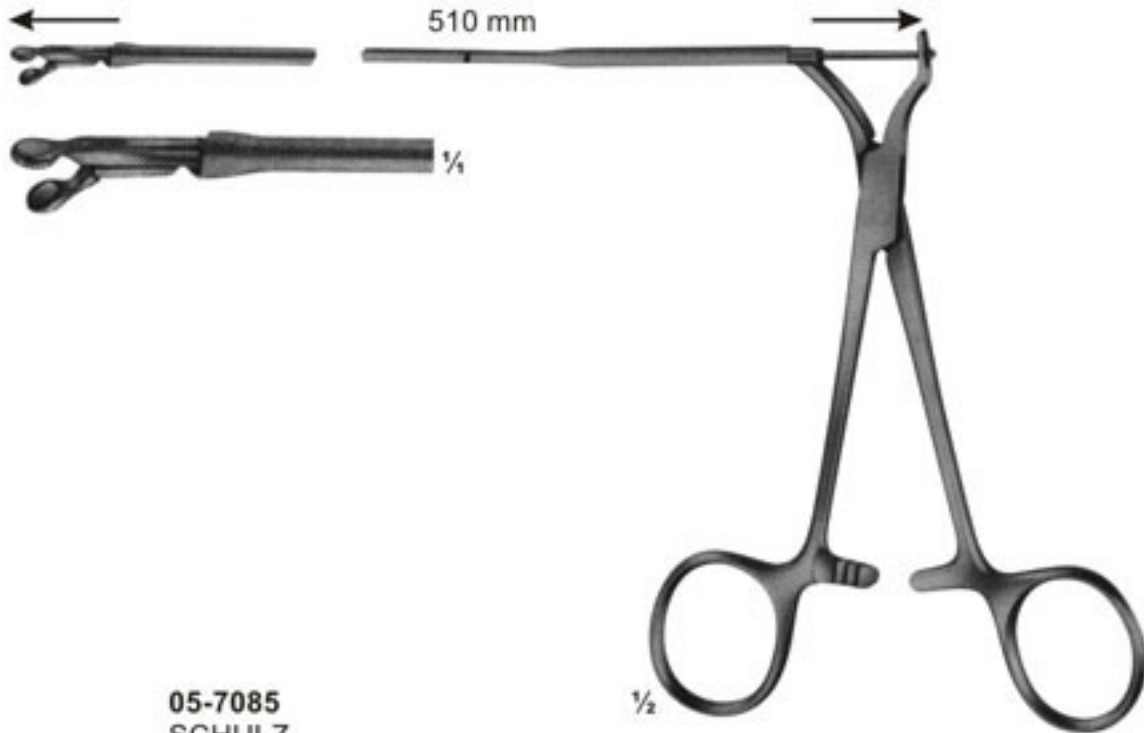

**05-7085  
SCHULZ**  
Bioptome, with flexible Shaft, 510 mm long,  
with round jaws 3 mm diam.

Biopsy forceps, for biopsy from the right atrium  
through cava jugularis, prior to heart implantations.

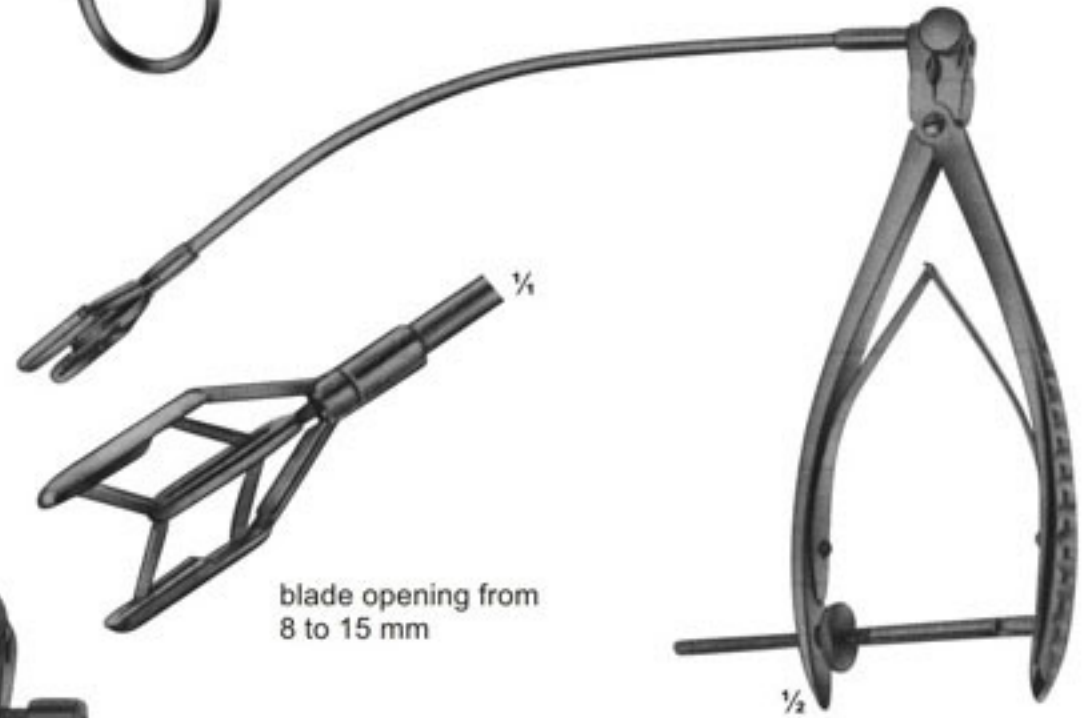

**05-7087  
COOLEY**  
Dilator for  
mitral valve  
for children

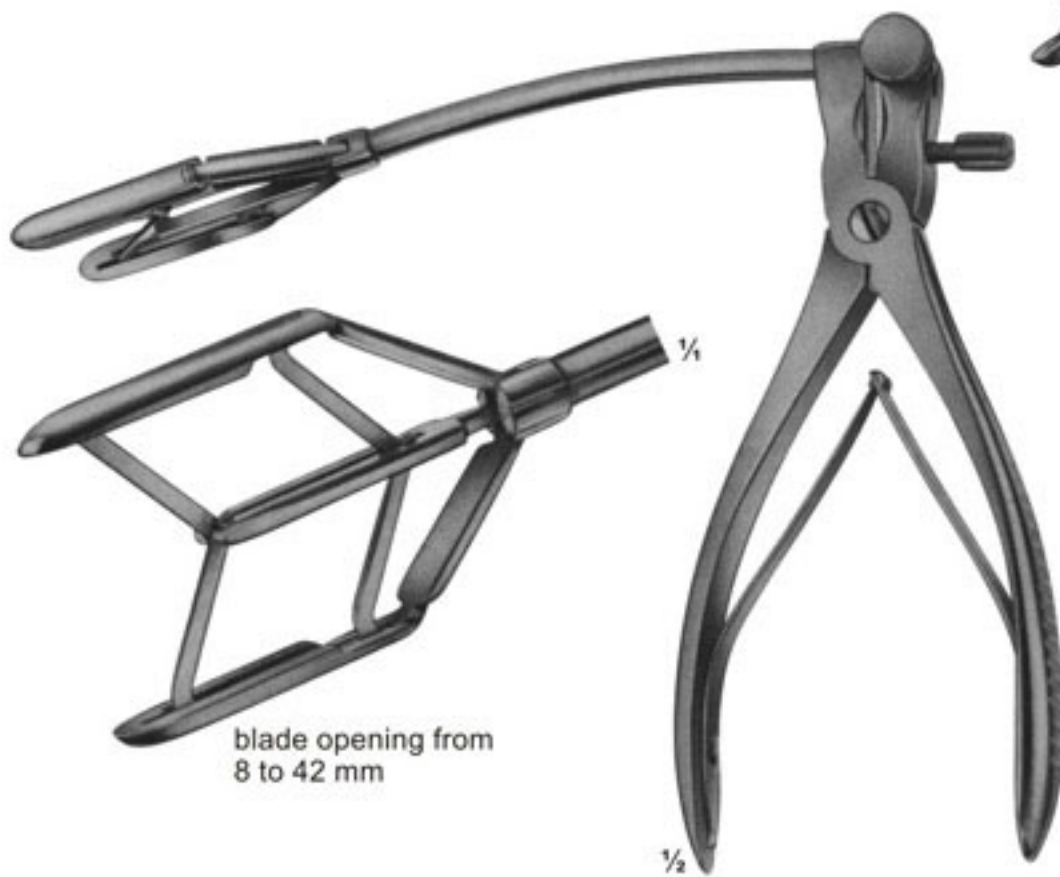

blade opening from  
8 to 42 mm

**05-7086  
TUBBS**  
Dilator for  
mitral valve





# JENKER Instrument Set For Tunnelling And Pulling-Through Vascular Grafts Toothings

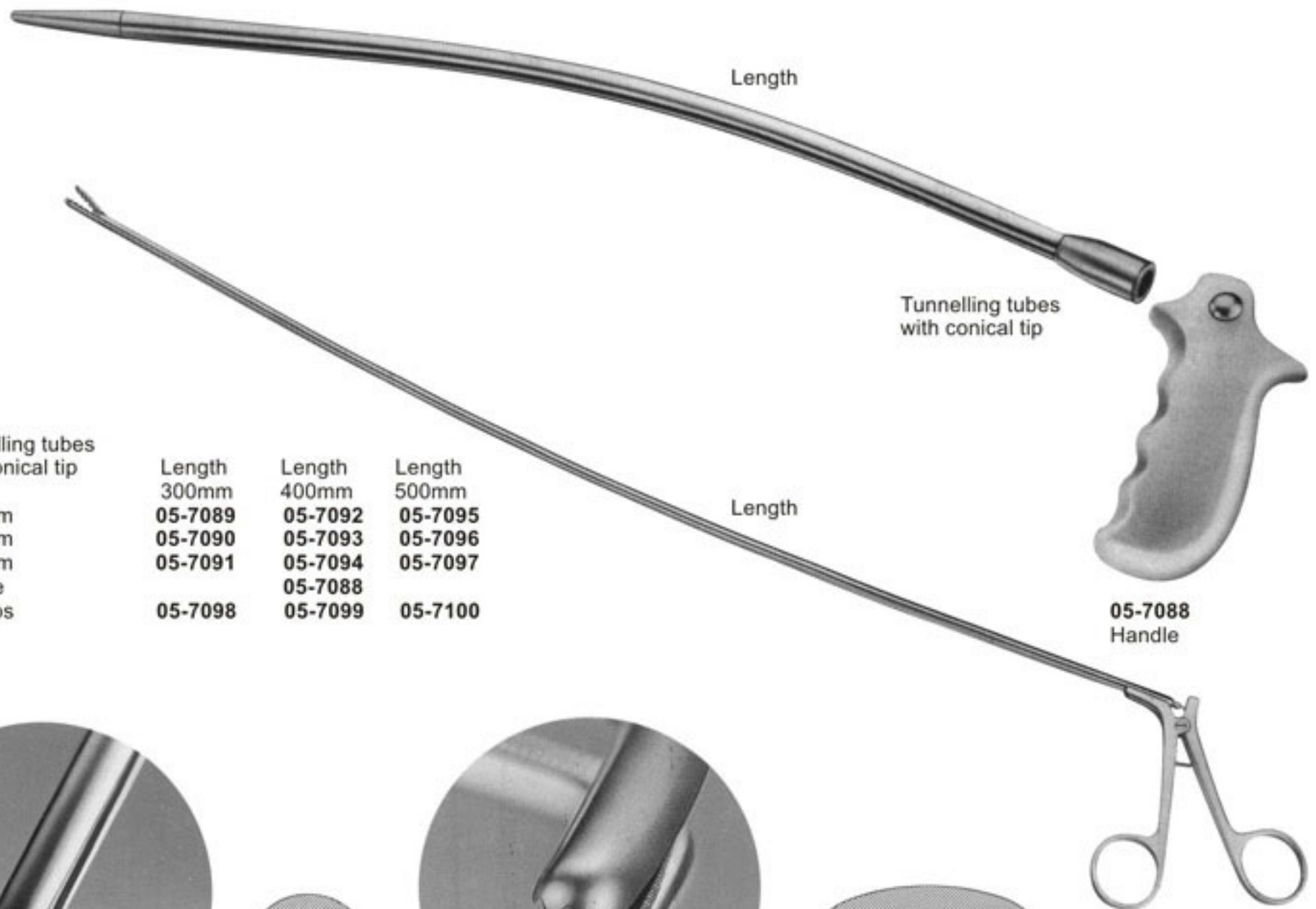

Tunnelling tubes with conical tip	Length 300mm	Length 400mm	Length 500mm
∅ 12mm	05-7089	05-7092	05-7095
∅ 14mm	05-7090	05-7093	05-7096
∅ 17mm	05-7091	05-7094	05-7097
Handle		05-7088	
Forceps	05-7098	05-7099	05-7100



**DE BAKEY**  
05-7101  
1 : 2 rows of teeth

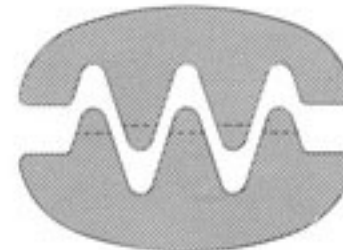

**DE BAKEY**  
05-7102  
2 : 3 rows of teeth

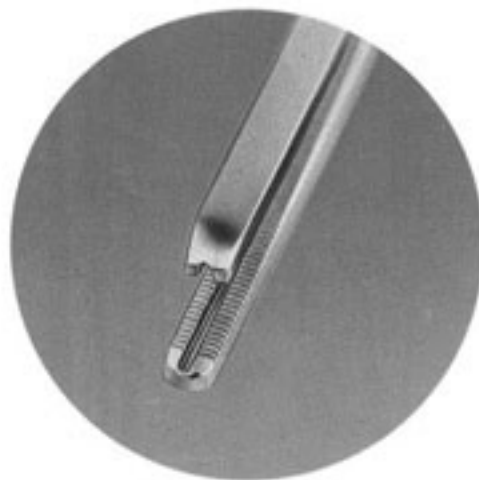

**COOLEY**  
05-7103  
2 : 2 rows of teeth

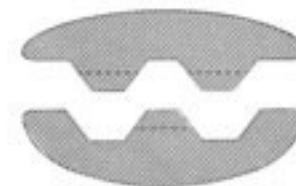
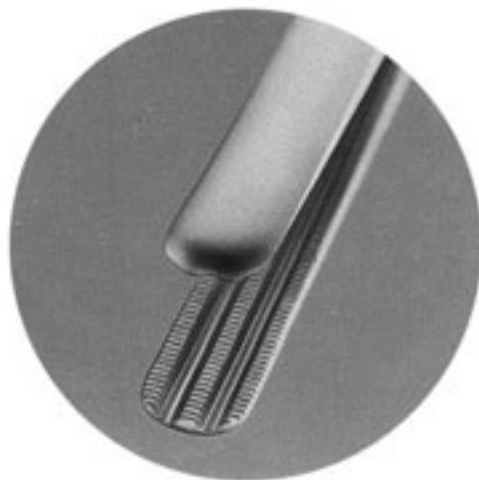

**DARDIK**  
05-7104  
2 : 3 rows of teeth



05-7098  
Forceps



# Atraumata Ultra-Light-Forceps

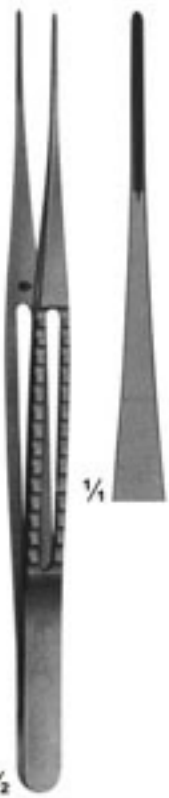

**05-7105**  
Width of jaws 1.2 mm  
Length 150mm

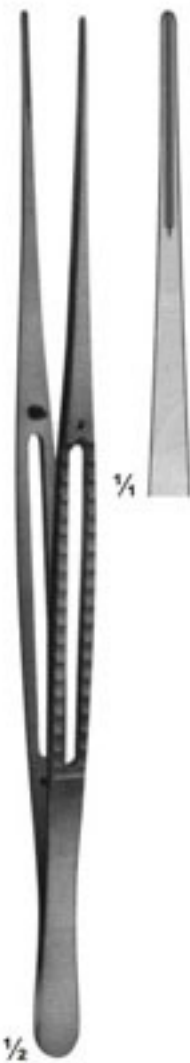

**05-7106**  
Width 1,5 mm  
Lenght 200 mm



**05-7107**  
Width 1,5 mm  
Lenght 240 mm



**05-7108**  
Width 1,5 mm  
Lenght 300 mm





# Atraumata Dissecting Forceps

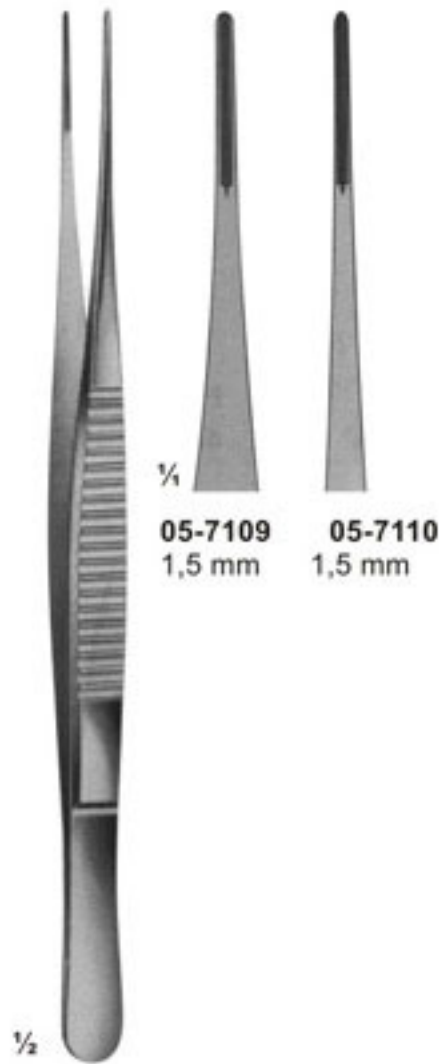

¼  
**05-7109** 1,5 mm  
**05-7110** 1,5 mm

½  
**05-7109 - 05-7110**  
 DE BAKEY  
 150 mm  
 300 mm

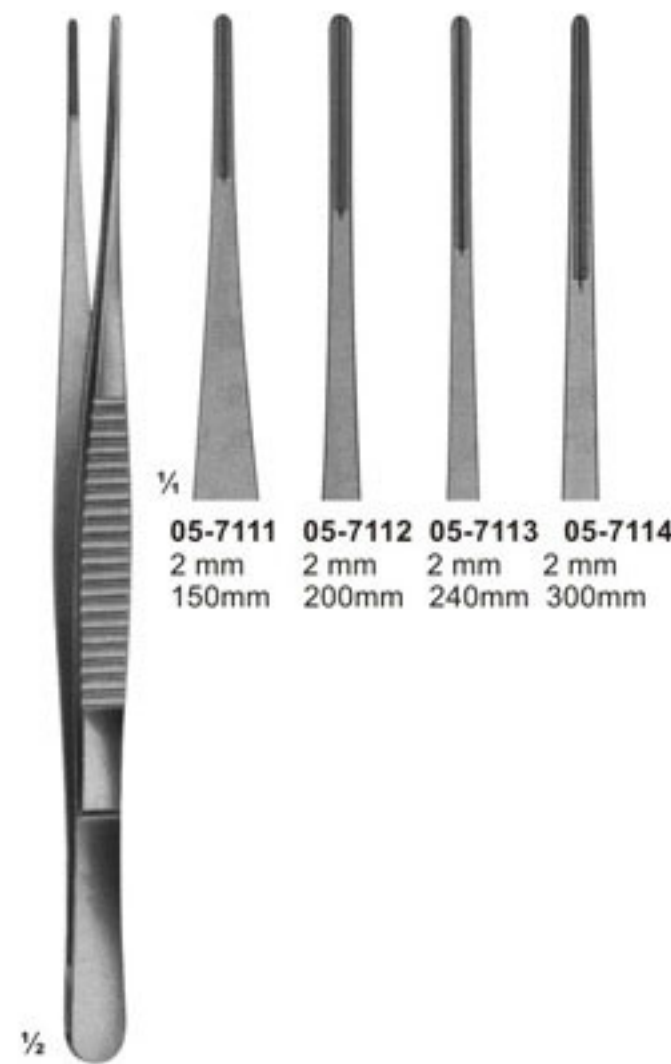

¼  
**05-7111** 2 mm 150mm  
**05-7112** 2 mm 200mm  
**05-7113** 2 mm 240mm  
**05-7114** 2 mm 300mm

½  
**05-7111 - 05-7114**  
 DE BAKEY

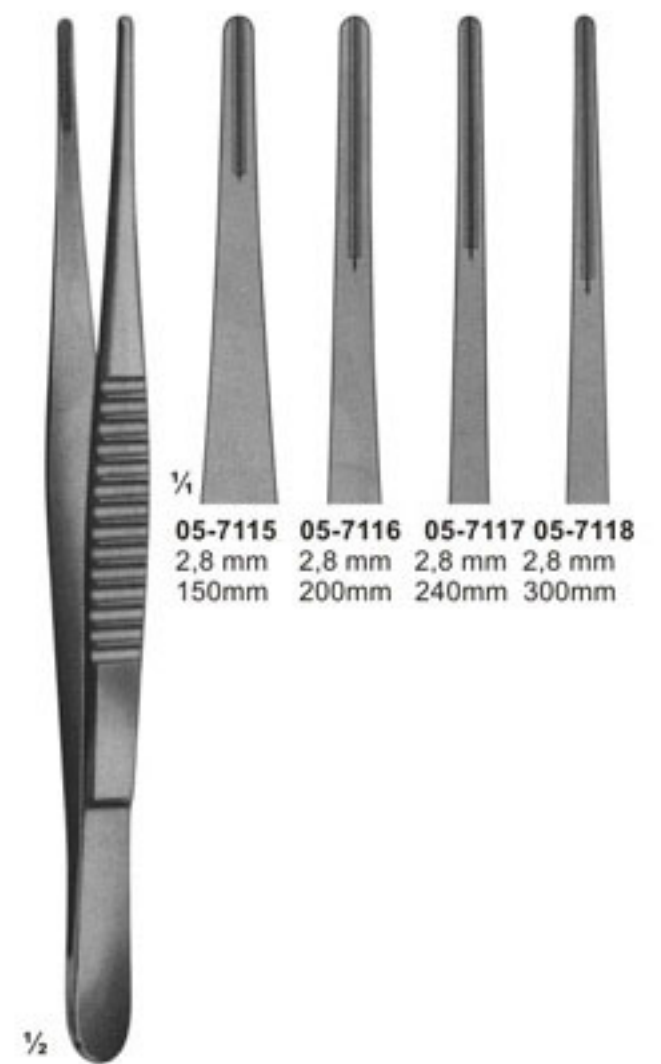

¼  
**05-7115** 2,8 mm 150mm  
**05-7116** 2,8 mm 200mm  
**05-7117** 2,8 mm 240mm  
**05-7118** 2,8 mm 300mm

½  
**05-7115 - 05-7118**  
 DE BAKEY

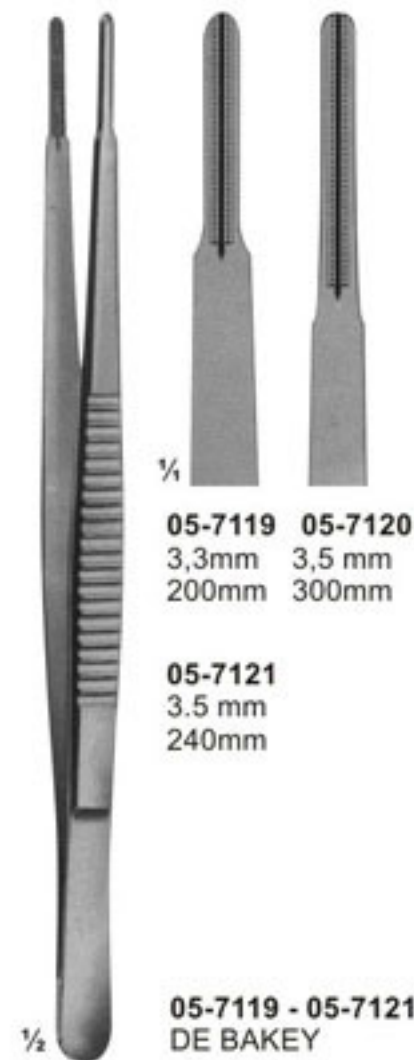

¼  
**05-7119** 3,3mm 200mm  
**05-7120** 3,5 mm 300mm

**05-7121**  
 3.5 mm  
 240mm

½  
**05-7119 - 05-7121**  
 DE BAKEY

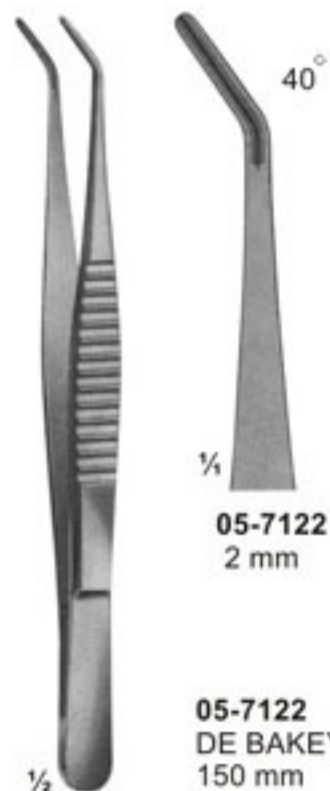

¼  
 40°  
**05-7122**  
 2 mm

½  
**05-7122**  
 DE BAKEY  
 150 mm

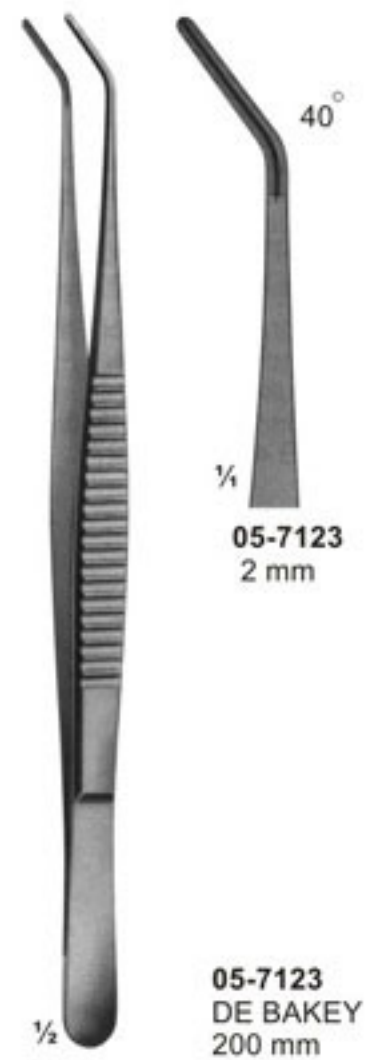

¼  
 40°  
**05-7123**  
 2 mm

½  
**05-7123**  
 DE BAKEY  
 200 mm



# Atraumata Ring Handle Bulldog Clamps

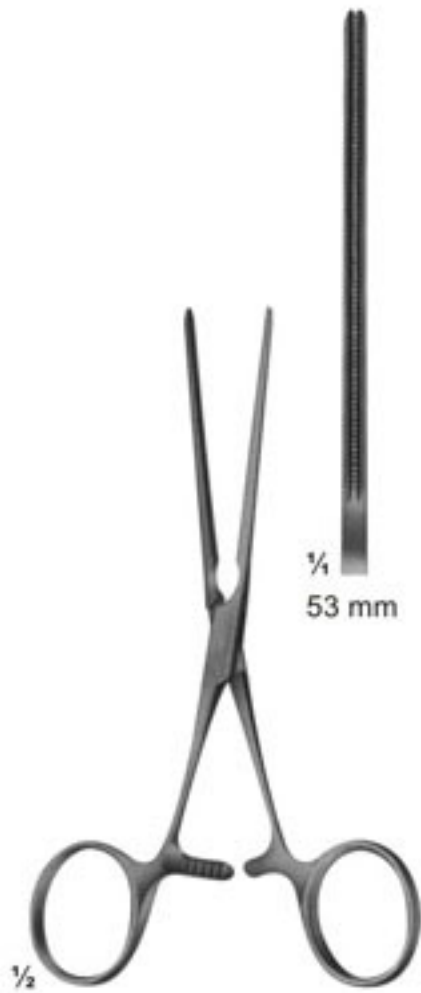

**05-7124**  
DE-BAKEY  
straight  
130 mm

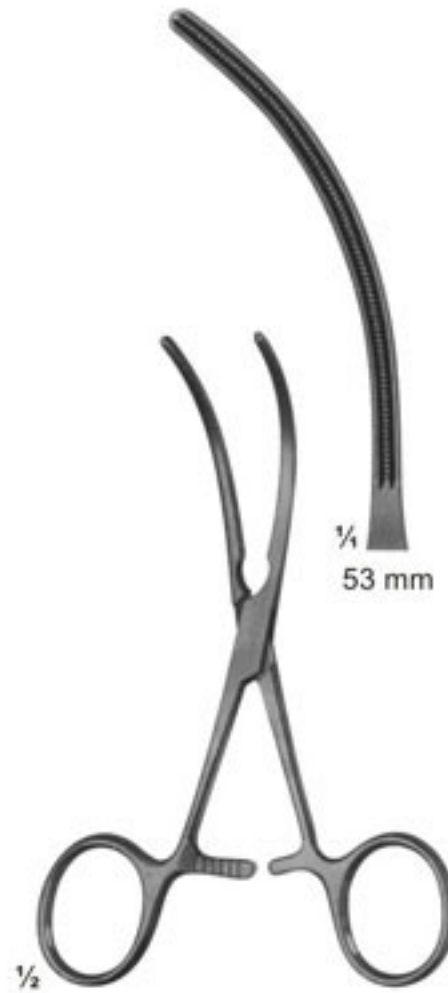

**05-7125**  
DE-BAKEY  
curved jaws  
125 mm

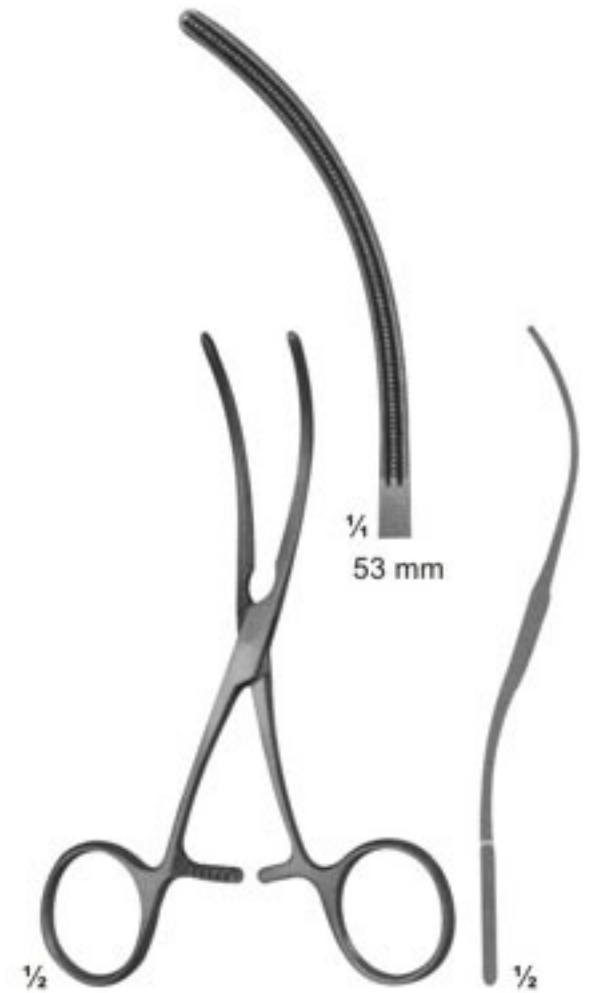

**05-7126**  
DE-BAKEY  
S-shaped curved  
125 mm

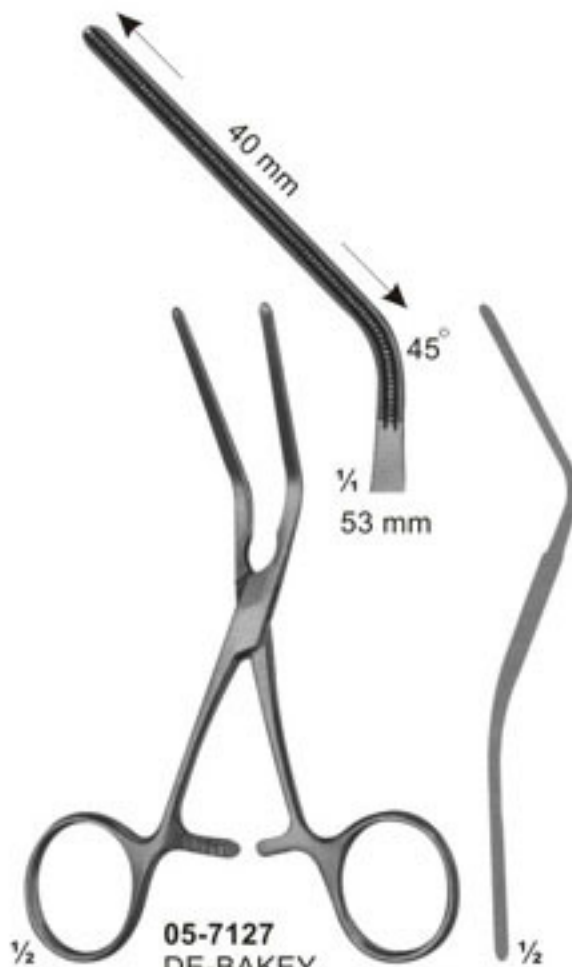

**05-7127**  
DE-BAKEY  
angled 45  
125 mm



**05-7128**  
DE-BAKEY  
angled 90  
105 mm





# Atraumata Anastomosis and Multi-Purpose-Clamps for Neonatales

graduated



1/2

05-7129 - 05-7132  
CASTANEDA

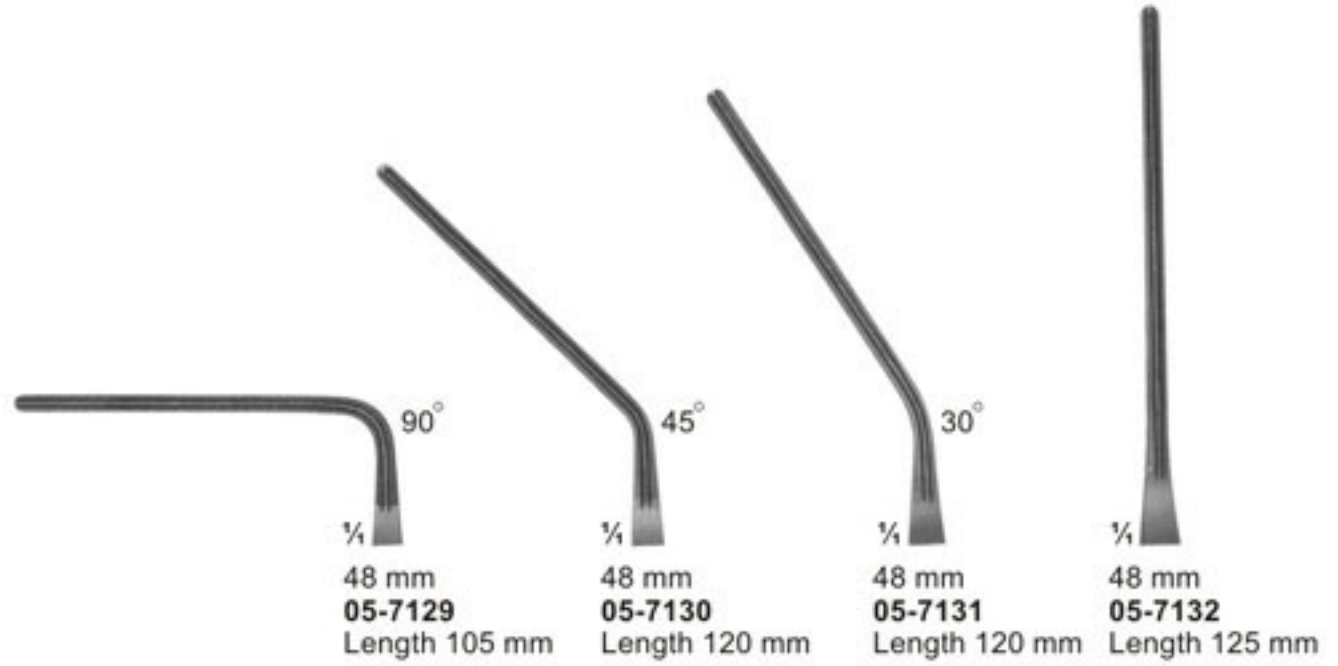

graduated



1/2

05-7133 - 05-7136  
CASTANEDA

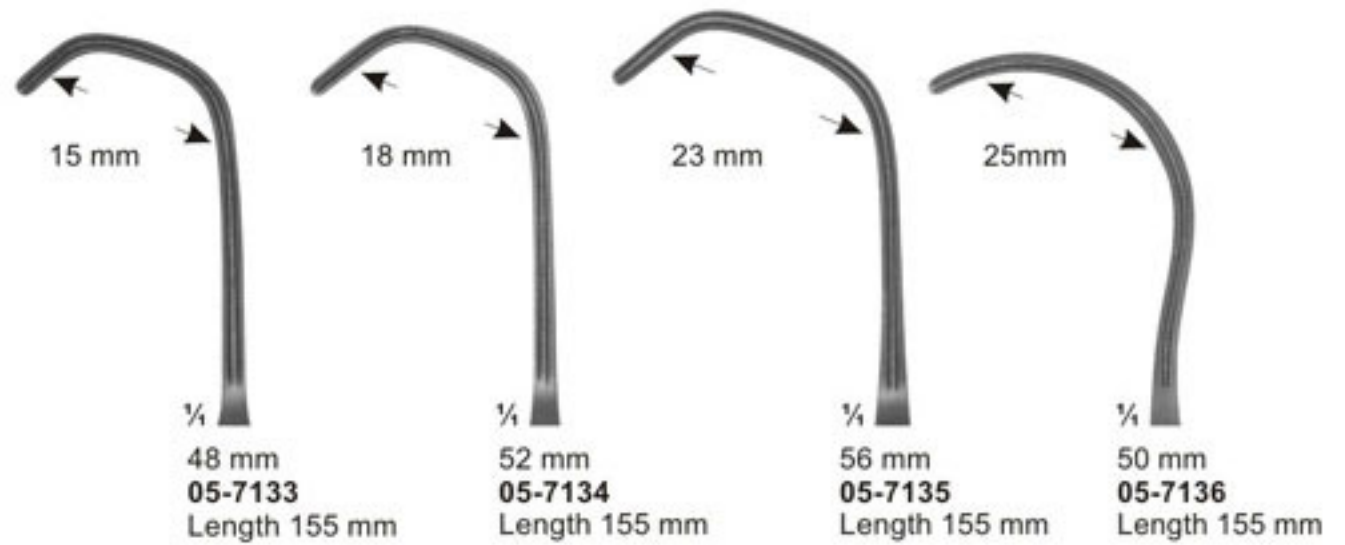



# Atraumata Anastomosis-and Multi-Purpose Clamps-Pediatric types

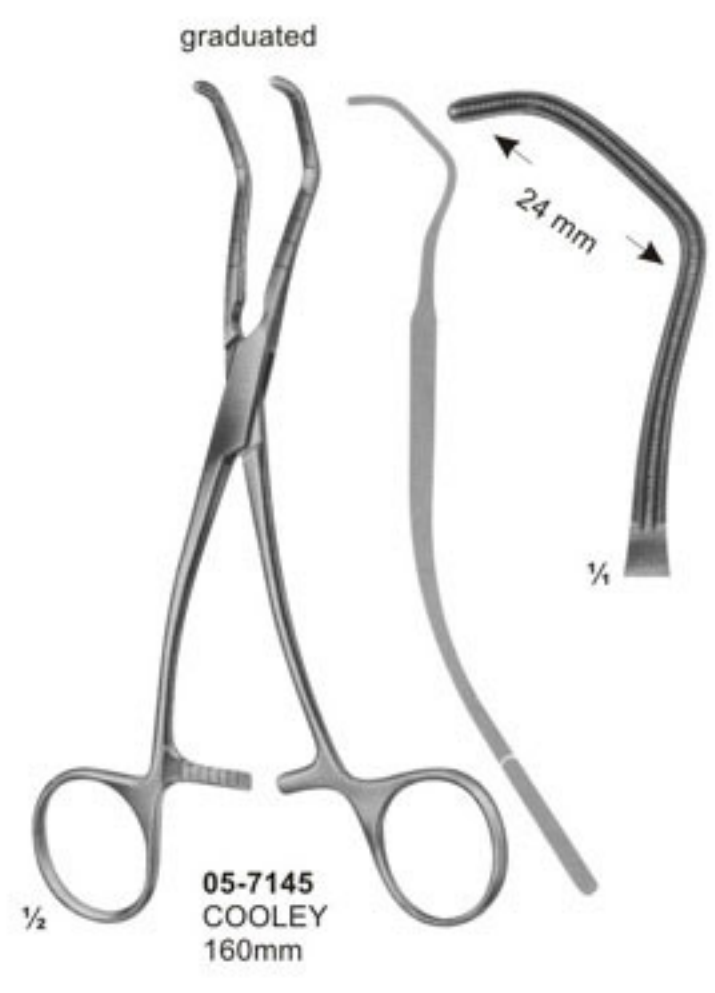
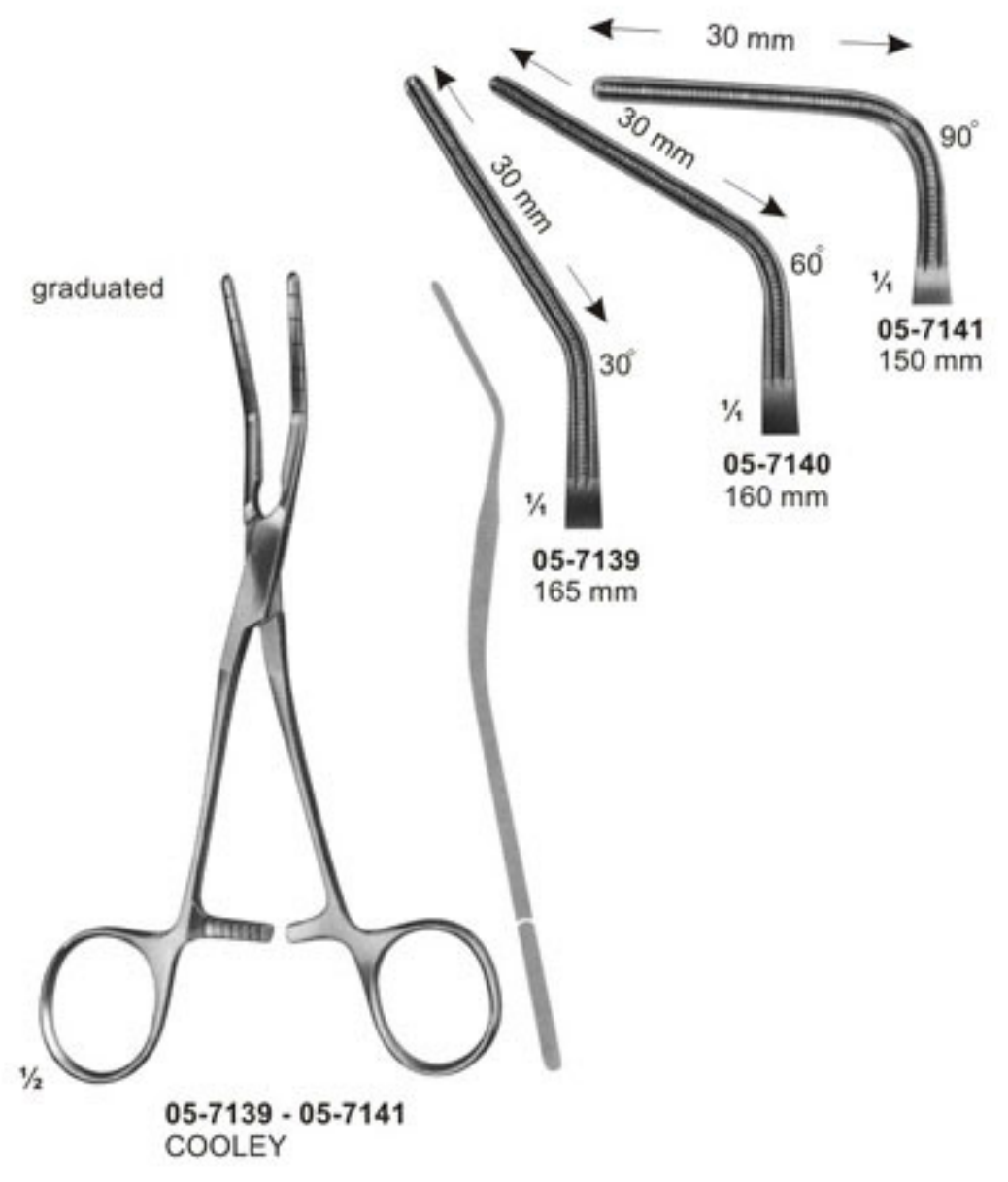
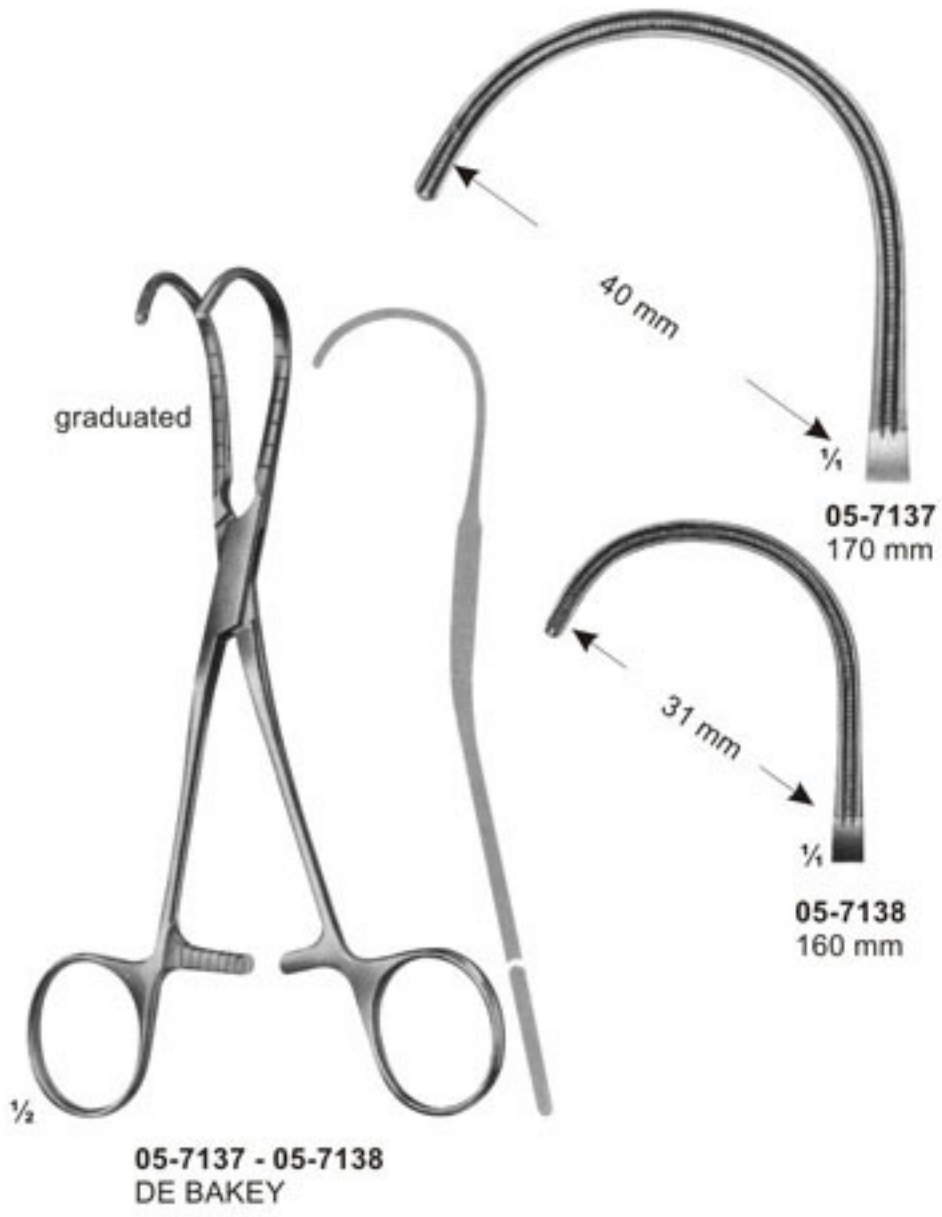





# Atraumata Non-traumatic Haemostatic Forceps

## Mosquito Forceps

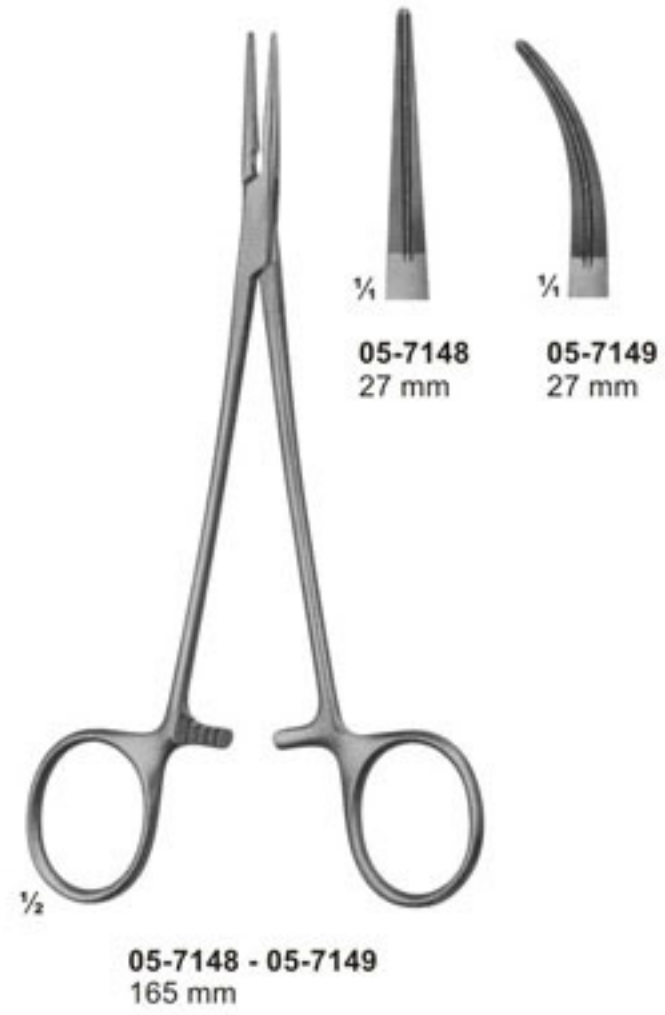



# Atraumata Non-traumatic Haemostatic Forceps

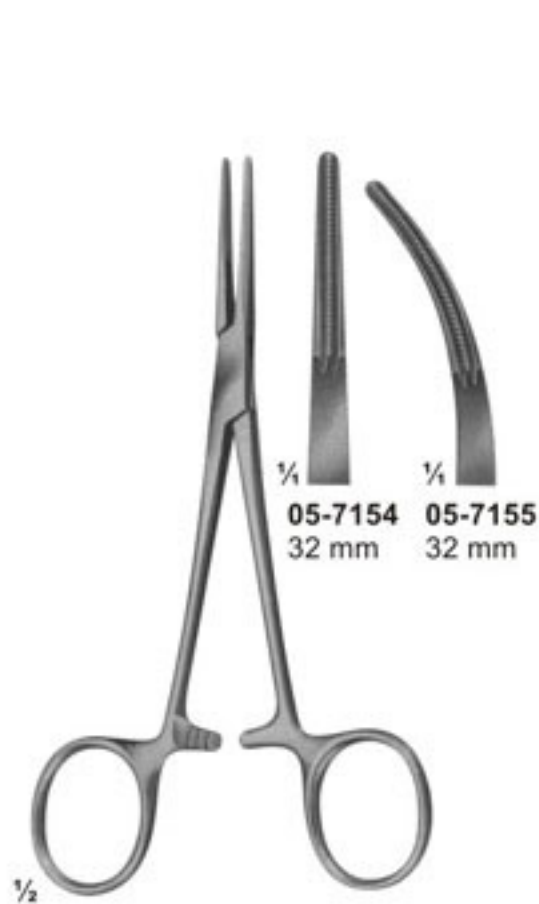

**05-7154 - 05-7155**  
DE-BAKEY-KELLY  
140 mm

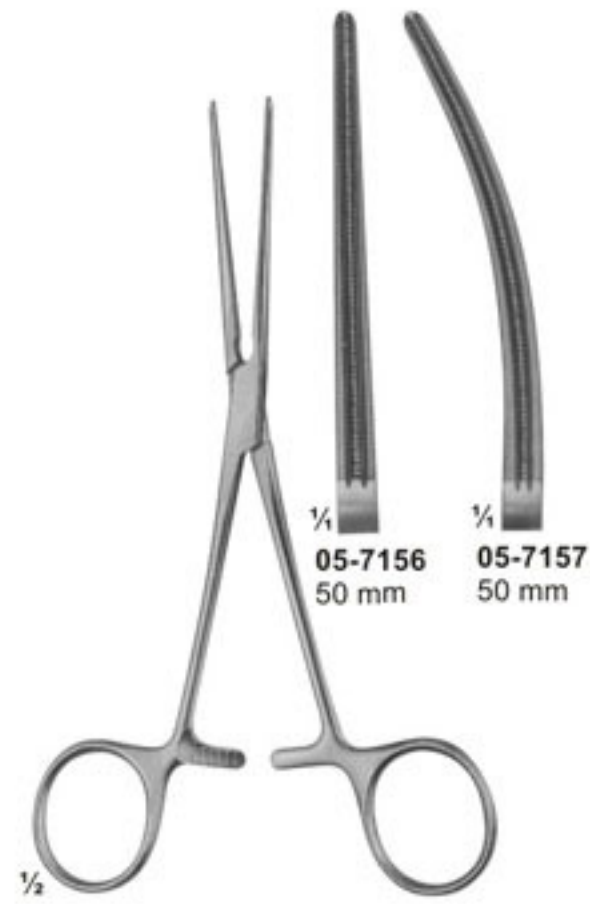

**05-7156 - 05-7157**  
PEAN  
155 mm

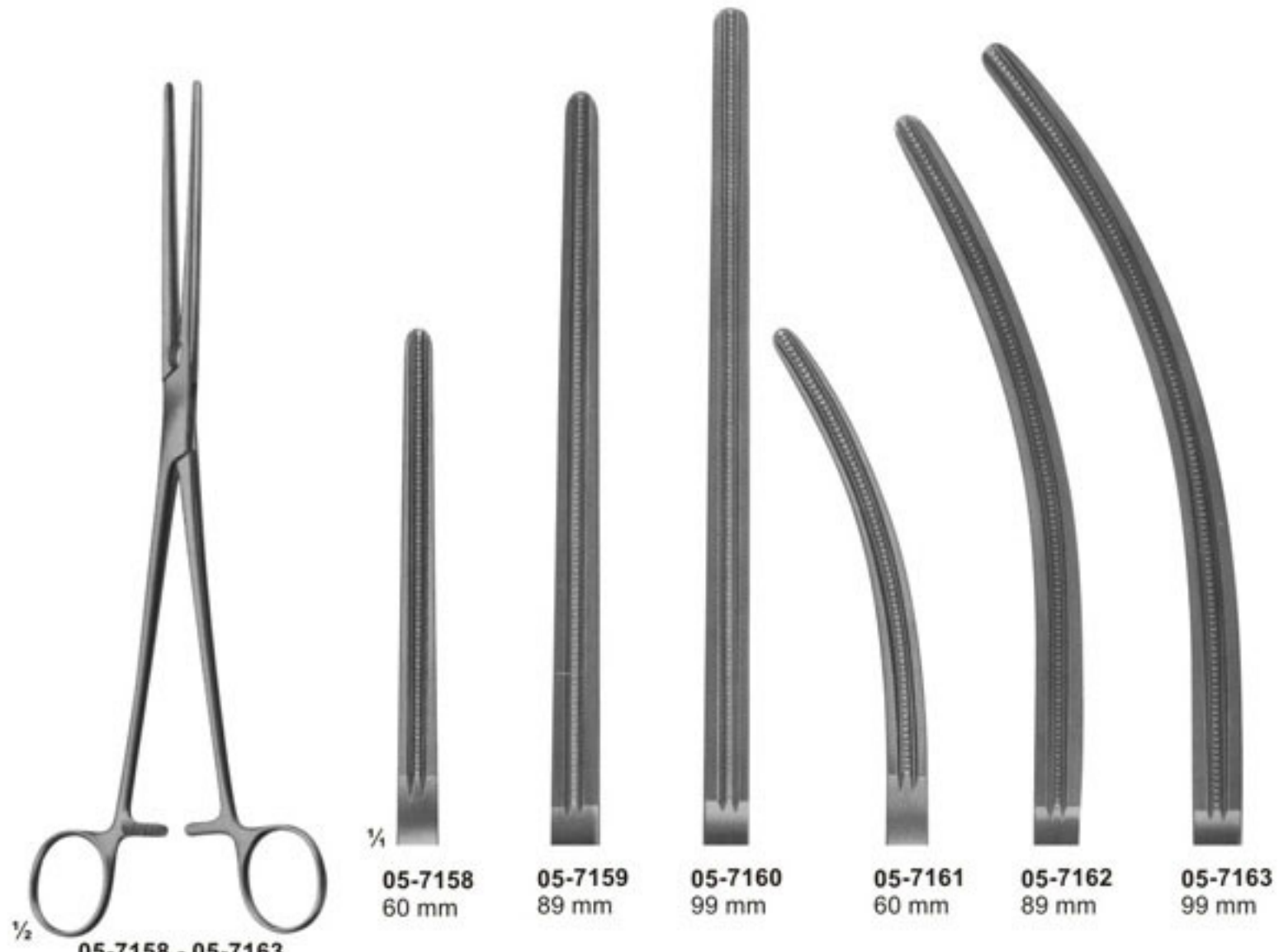

**05-7158 - 05-7163**  
DE-BAKEY-PEAN DE-BAKEY-PEAN  
05-7158 200 mm 05-7161 200 mm  
05-7159 265 mm 05-7162 260 mm  
05-7160 280 mm 05-7163 275 mm





# Atraumata Dissecting And Ligature Forceps Anastomosis Clamps

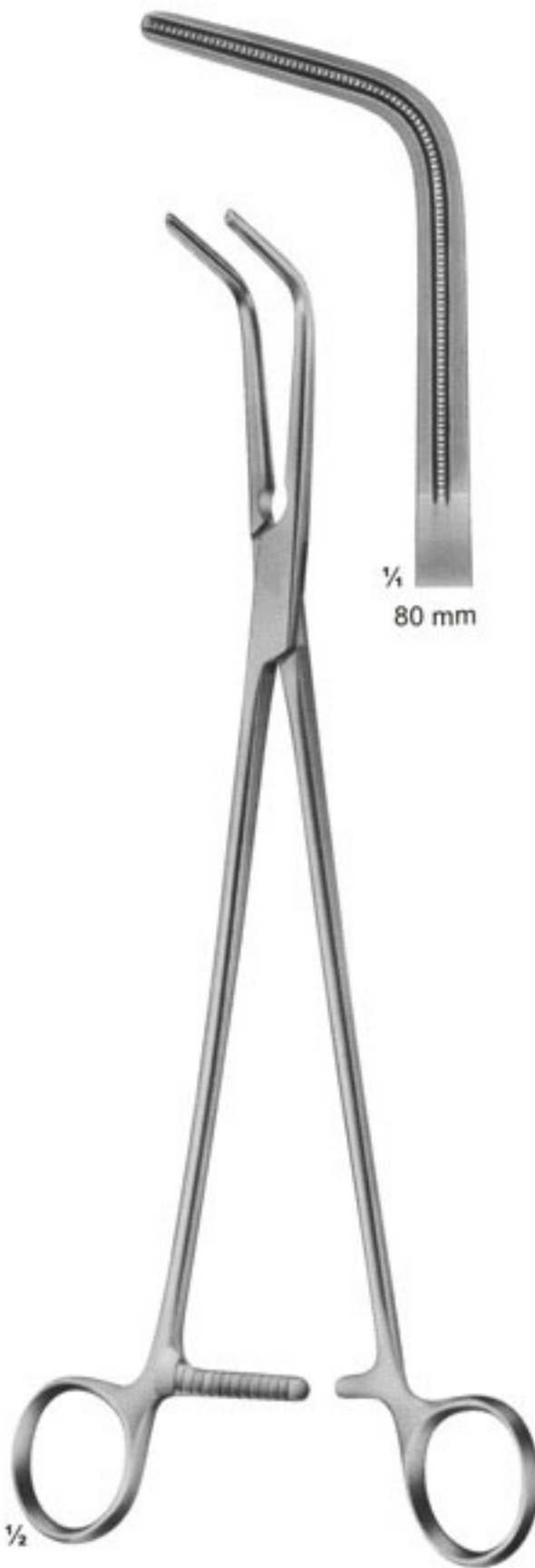

**05-7164**  
DE-BAKEY-MIXTER  
285 mm

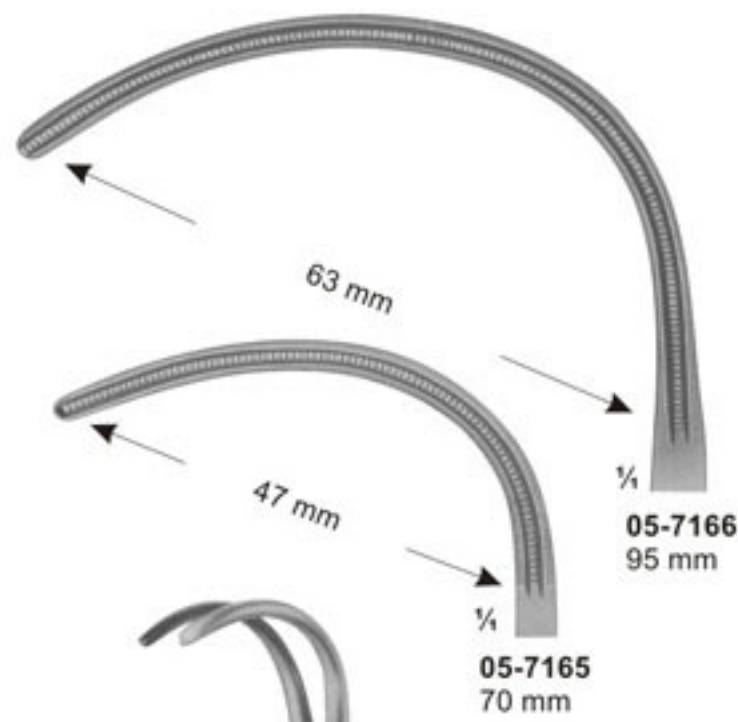

**05-7165 - 05-7166**  
GLOVER  
05-7165 195mm  
05-7166 210mm

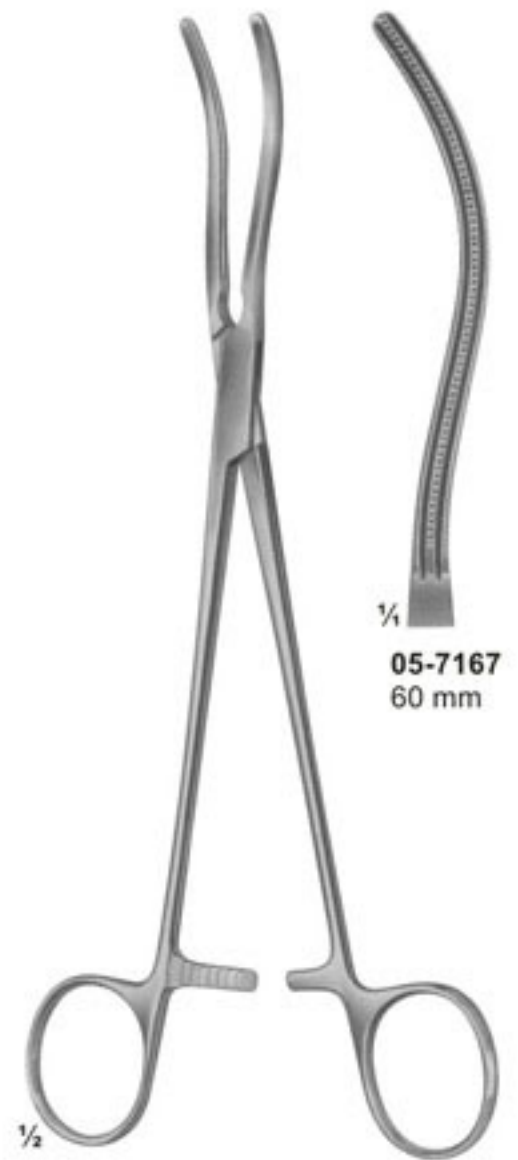

**05-7167**  
GLOVER  
220 mm



# Atraumata Anastomosis, Vena-Cava Clamps

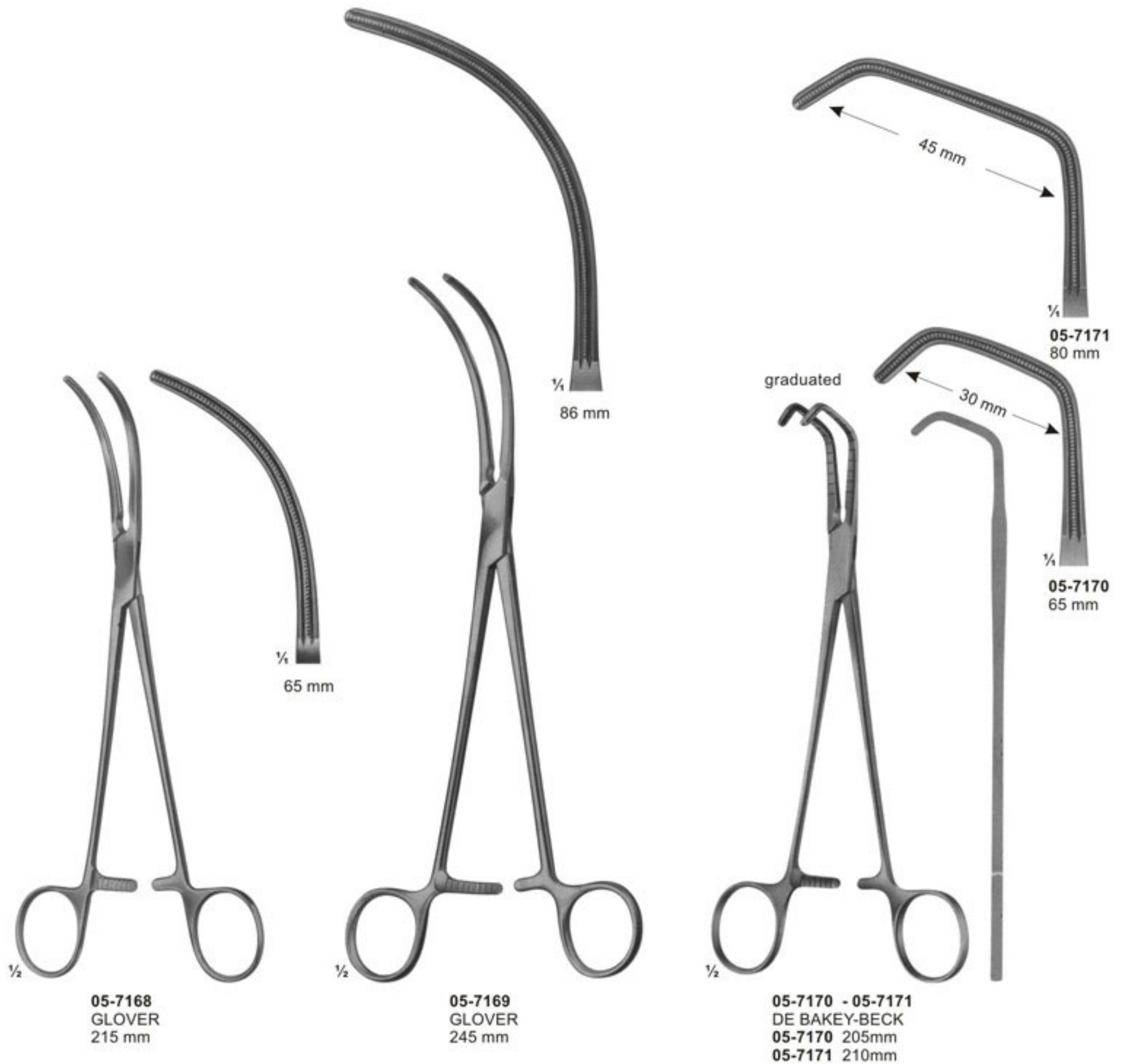





# Atraumata Vena-Cava Clamps And Tangential Occlusion Clamps



05-7172 - 05-7175  
DE BAKEY-HARKEN  
05-7172 - 255 mm  
05-7173 - 245 mm  
05-7174 - 245 mm  
05-7175 - 245 mm



graduated

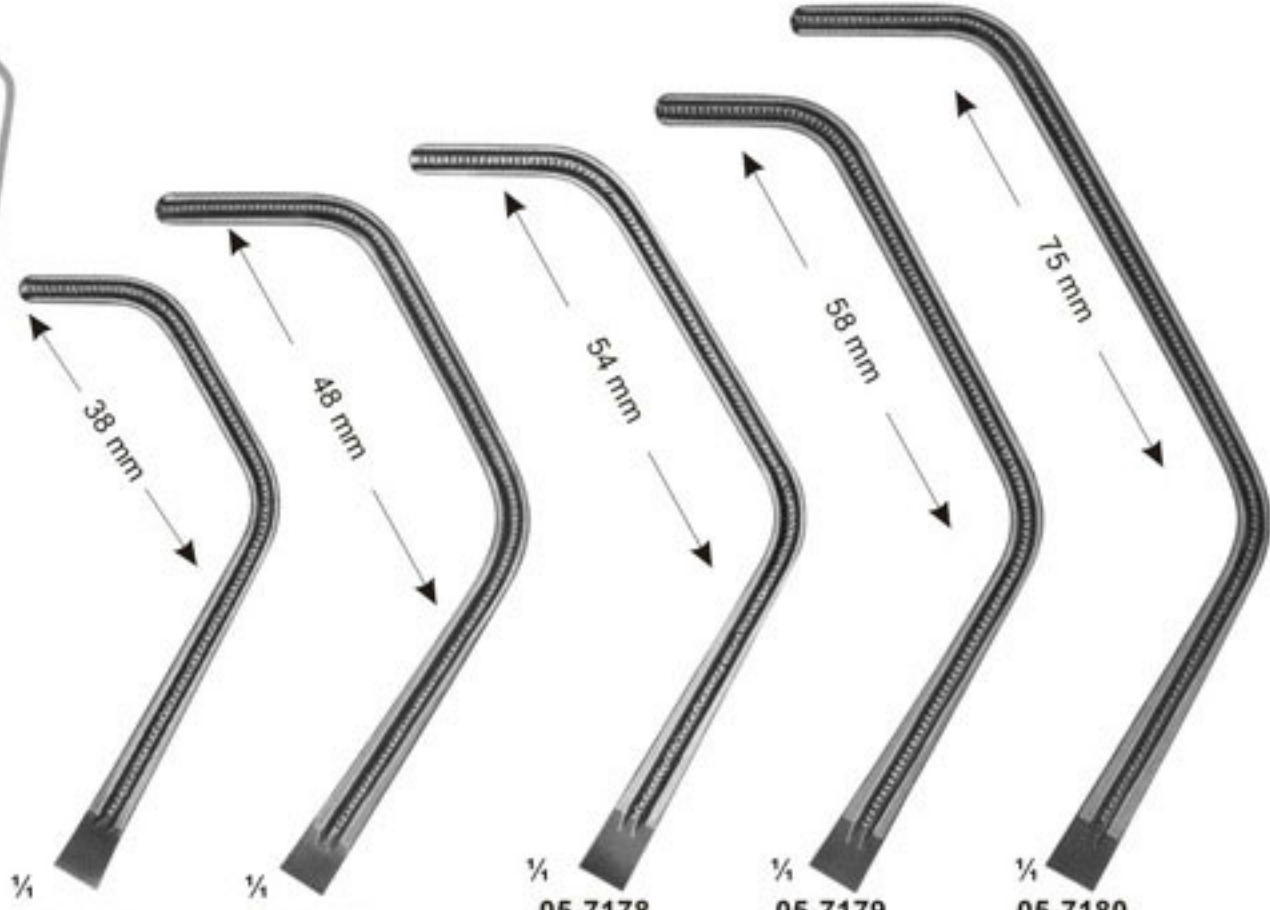

05-7176 - 05-7180  
DE BAKEY

Total Length: 220 mm

Length of jaws: 85 mm

05-7176

05-7177

05-7178

05-7179

05-7180

265 mm

270 mm

270 mm

280 mm

95 mm

99 mm

103 mm

119 mm



# Atraumata Tangential Occlusion And Coarctation Clamps



**05-7181 - 05-7183**  
DE BAKEY-SATINSKY

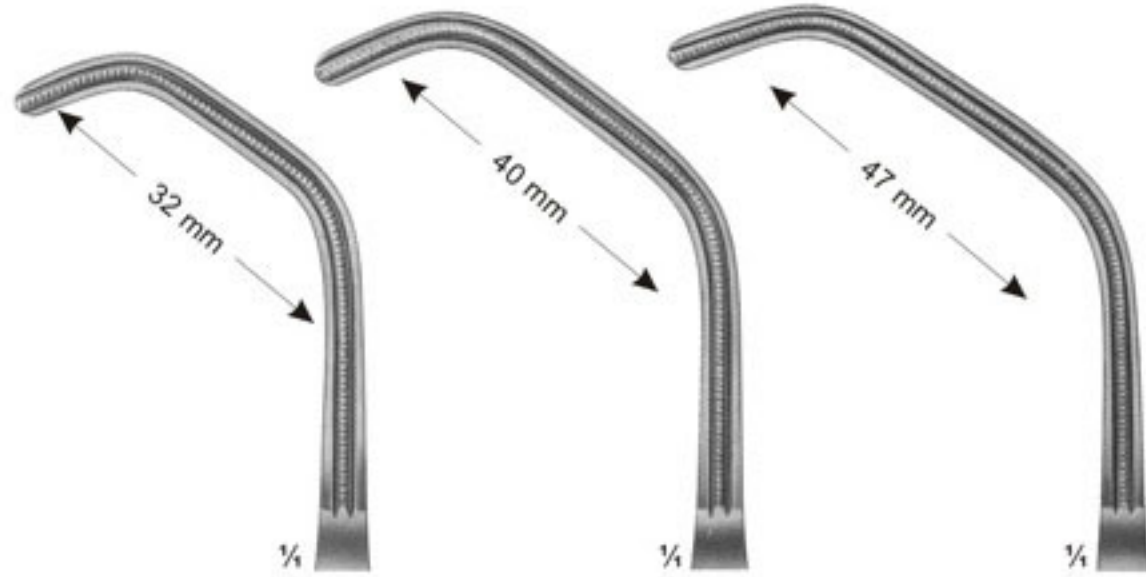

**05-7181**  
68 mm  
Length 235mm

**05-7182**  
76 mm  
Length 240mm

**05-7183**  
84 mm  
Length 245mm



**05-7184 - 05-7185**  
DE BAKEY  
05-7184 170mm  
05-7185 165mm



**05-7184**  
50 mm

**05-7185**  
50 mm

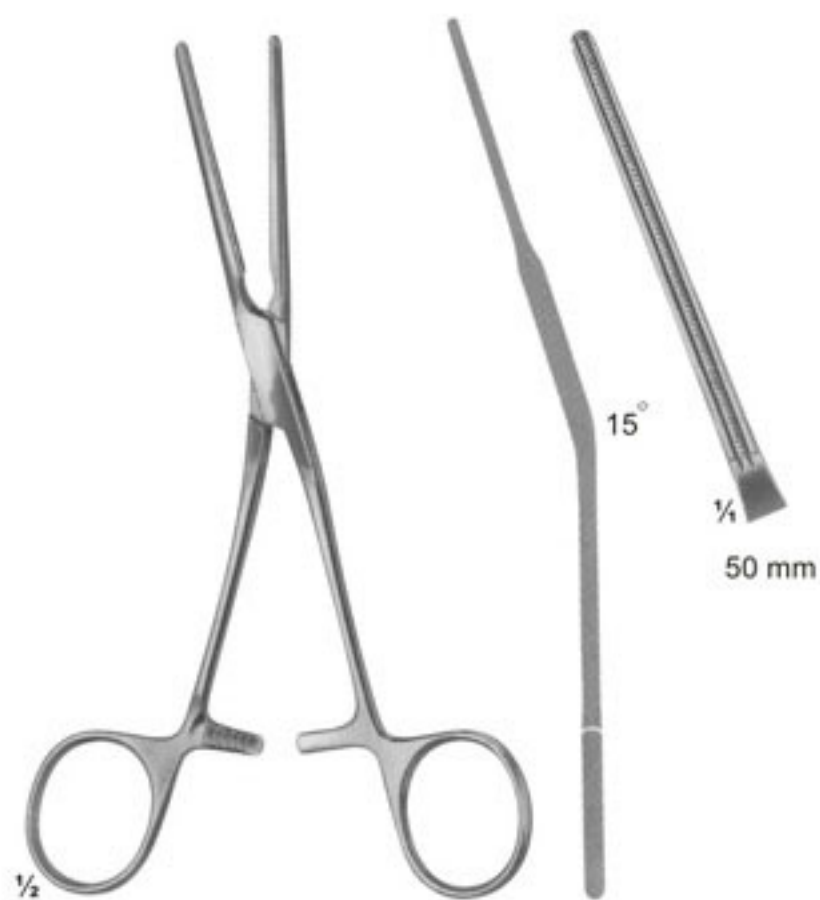

**05-7186**  
DE BAKEY  
165 mm





# Atraumata Coarctation Clamps, Patent-Ducts Clamps

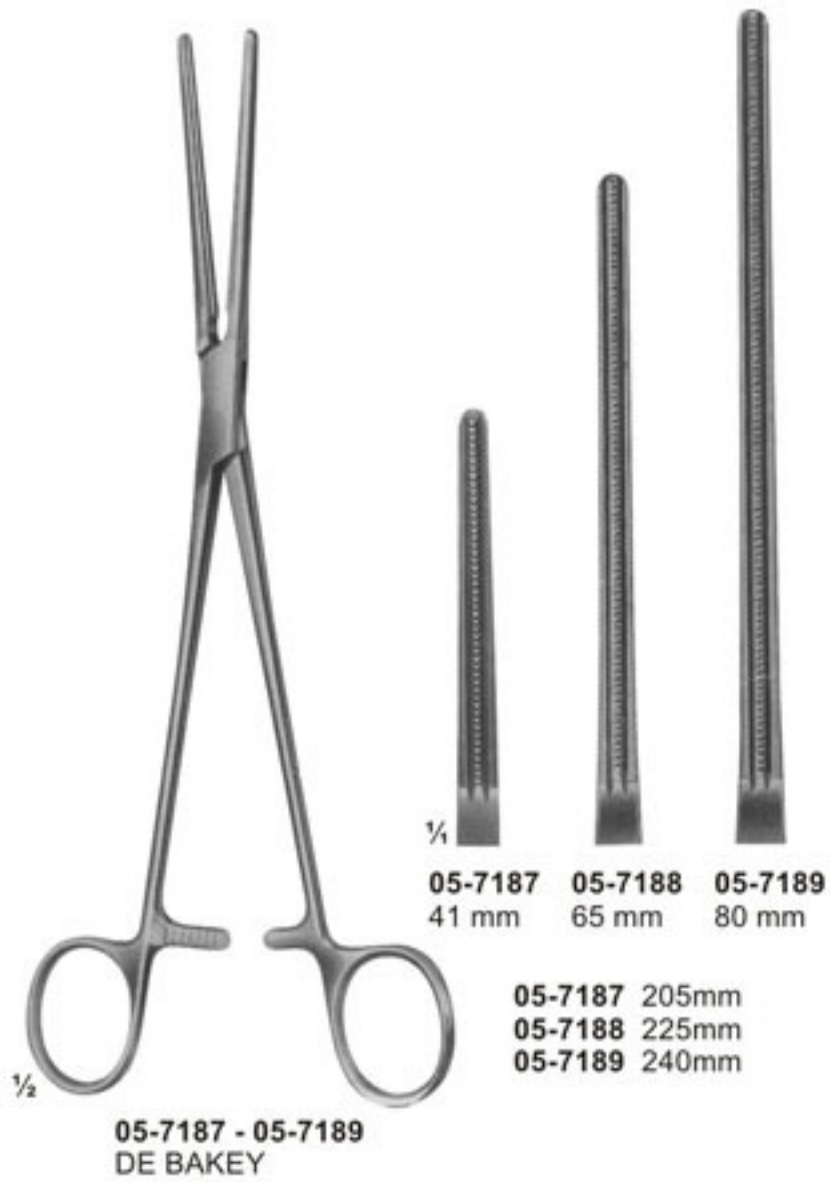



# Atraumata Peripheral-Vascular Clamps

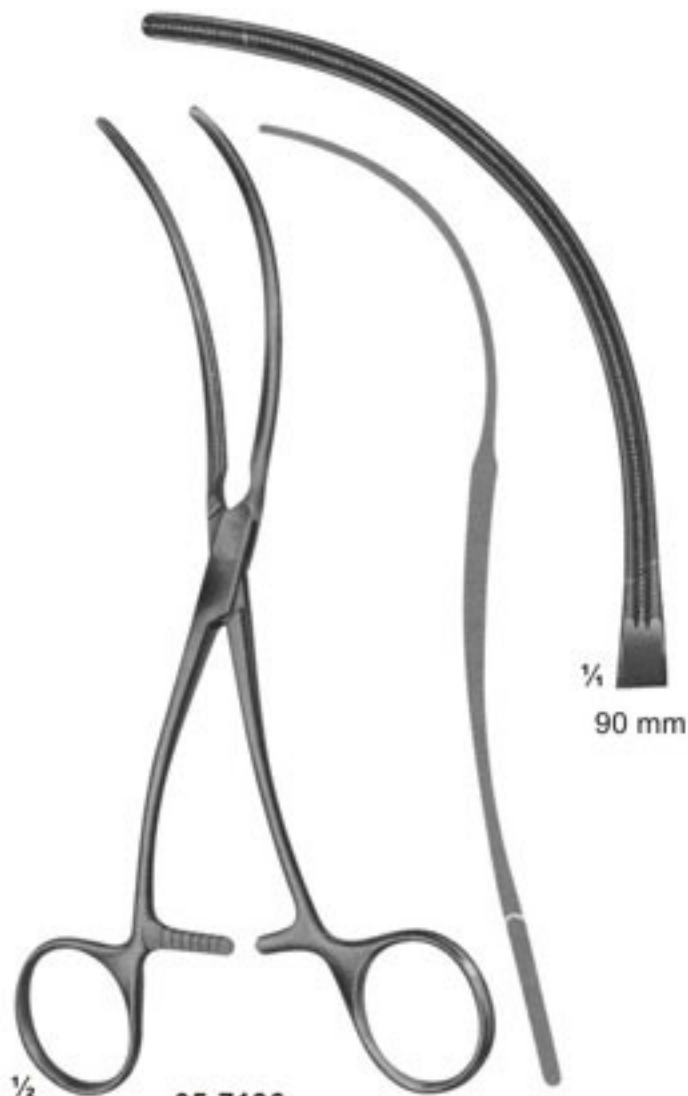

05-7196  
DE BAKEY  
190 mm

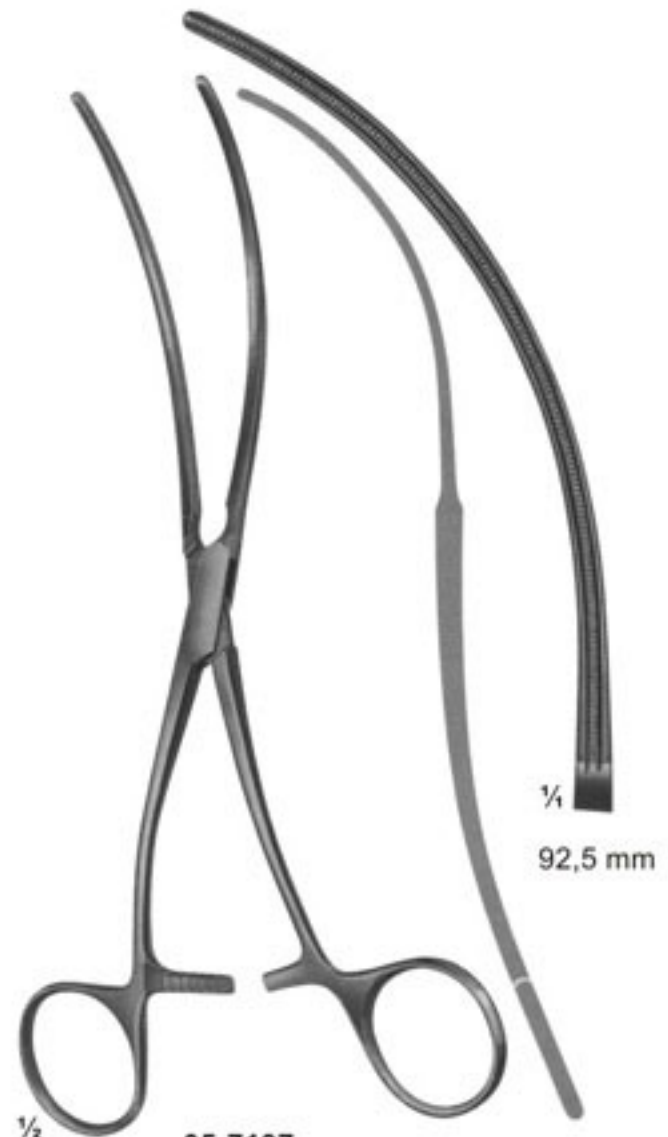

05-7197  
DE BAKEY  
200 mm

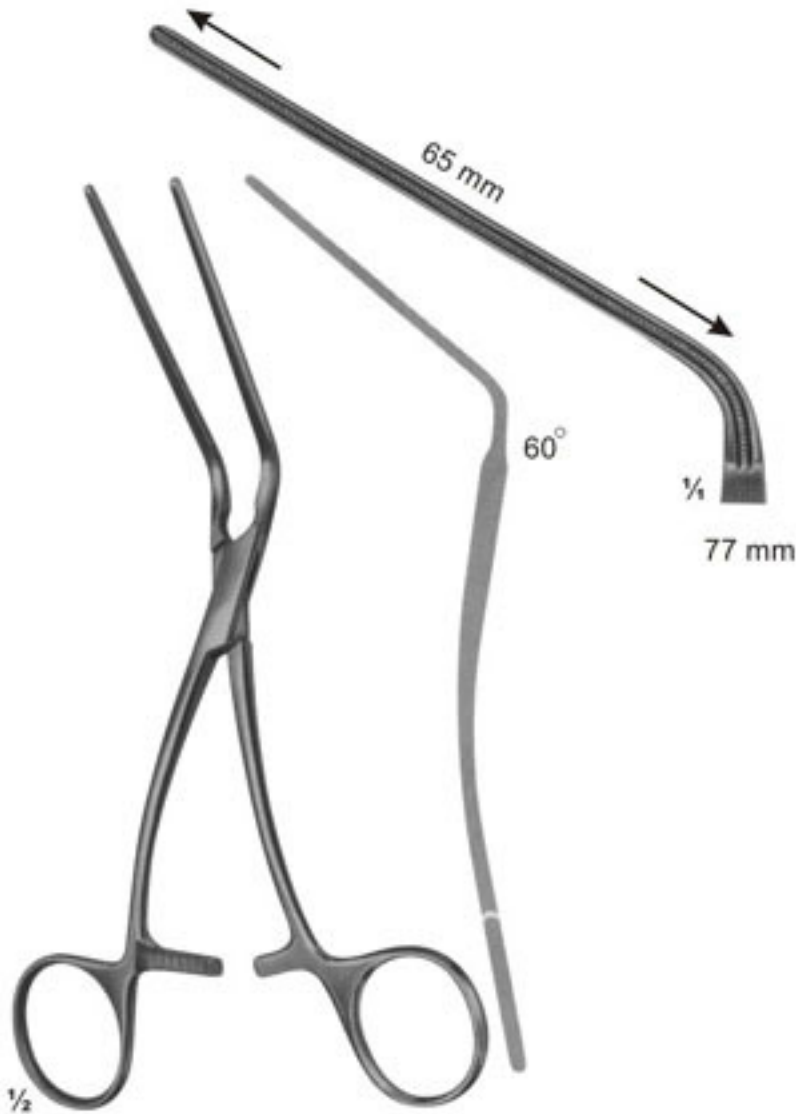

05-7198  
DE BAKEY  
180 mm

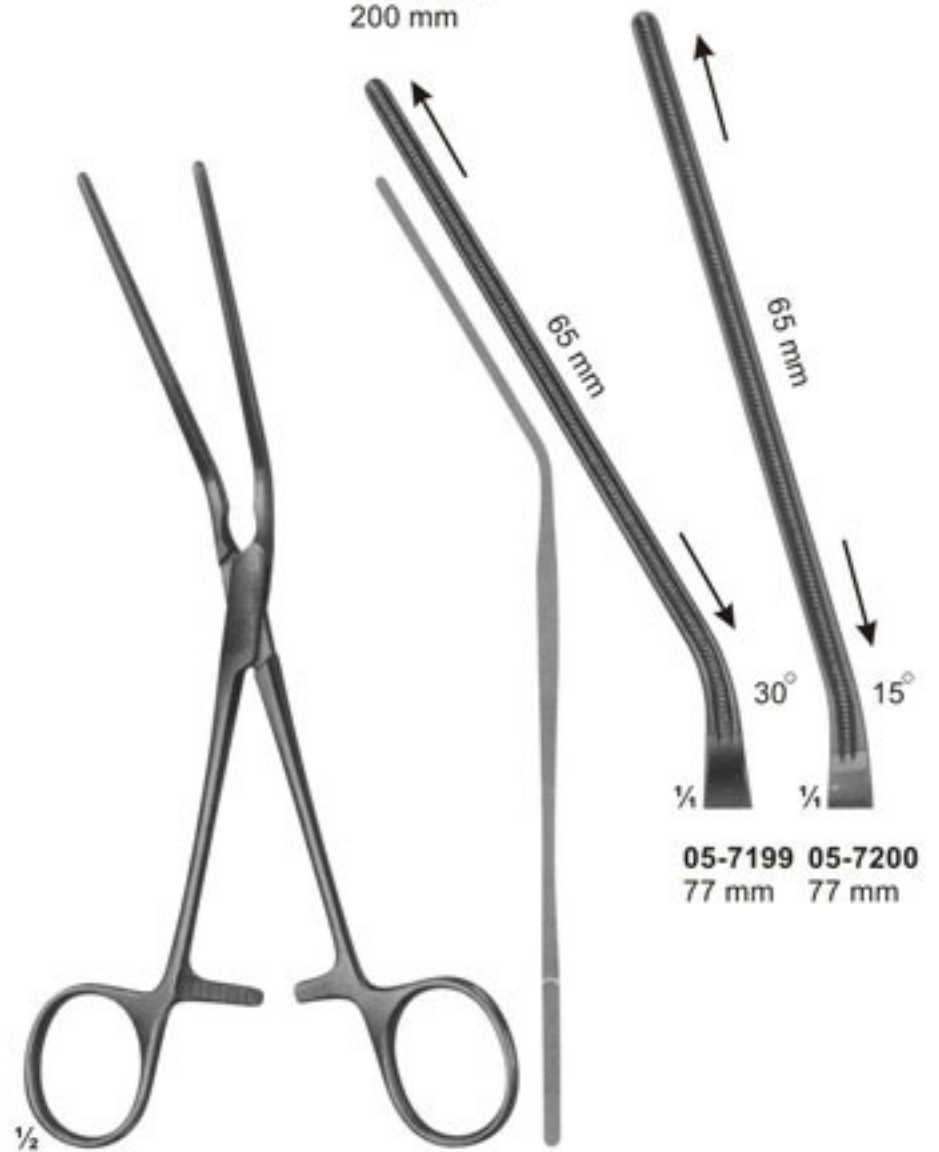

05-7199 - 05-7200  
LELAND-JONES  
190 mm





# Atraumata Peripheral Vascular And Anastomosis Clamps



**05-7201**  
LELAND-JONES  
195 mm



**05-7202**  
DE BAKEY  
200 mm

Iliac clamp

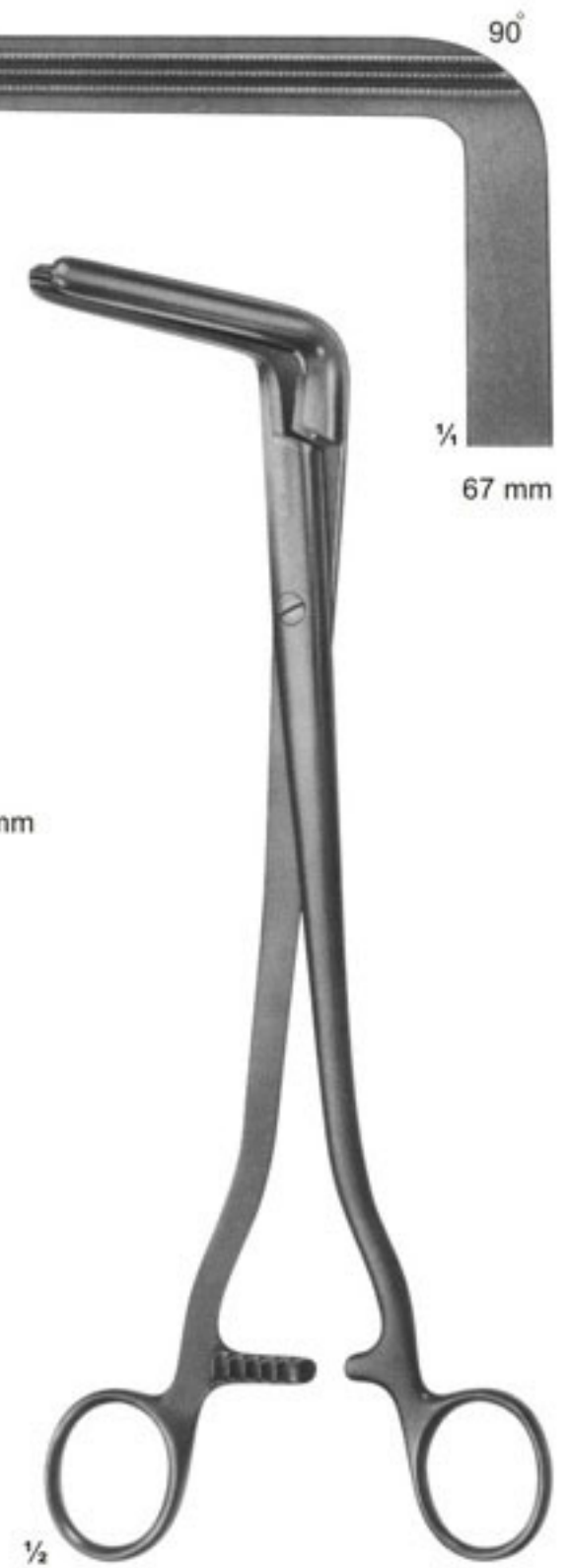

**05-7203**  
WERTHEIM  
250 mm



# Atraumata Anastomosis And Ascending Aotra Cross Clamps



**05-7204**  
78 mm

**05-7205**  
88 mm

**05-7206**  
98 mm

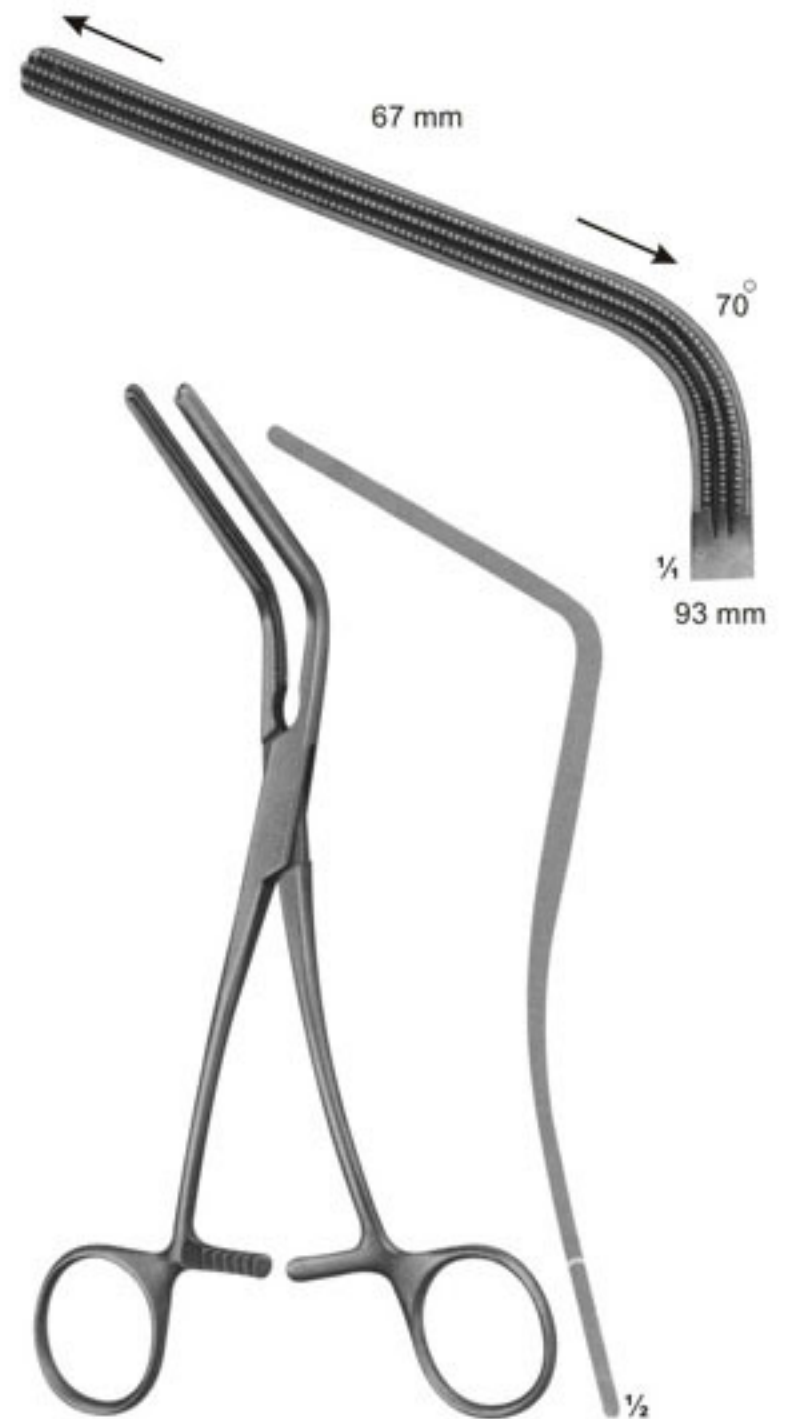

**05-7207**  
MORRIS  
175 mm

**05-7204 - 05-7206**  
DICK  
**05-7204** 255mm  
**05-7205** 265mm  
**05-7206** 275mm





# Atraumata Ascending Aorta Cross, Bronchus Clamps

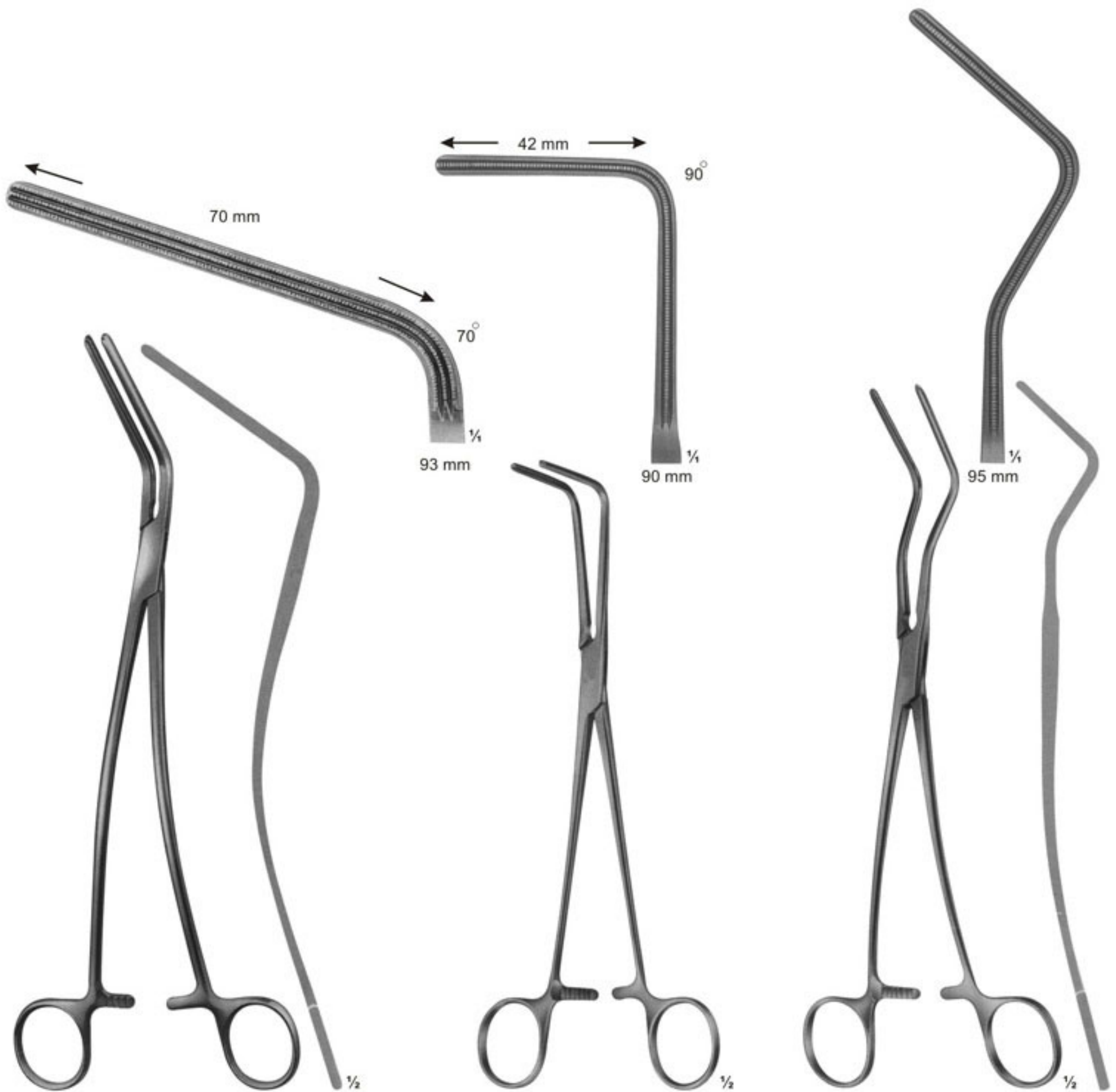

05-7208  
DE BAKEY (Morris Modif)  
240 mm

05-7209  
LEES  
220 mm

05-7210  
LEES  
245 mm



# Atraumata Aorta-Aneurysm Clamps

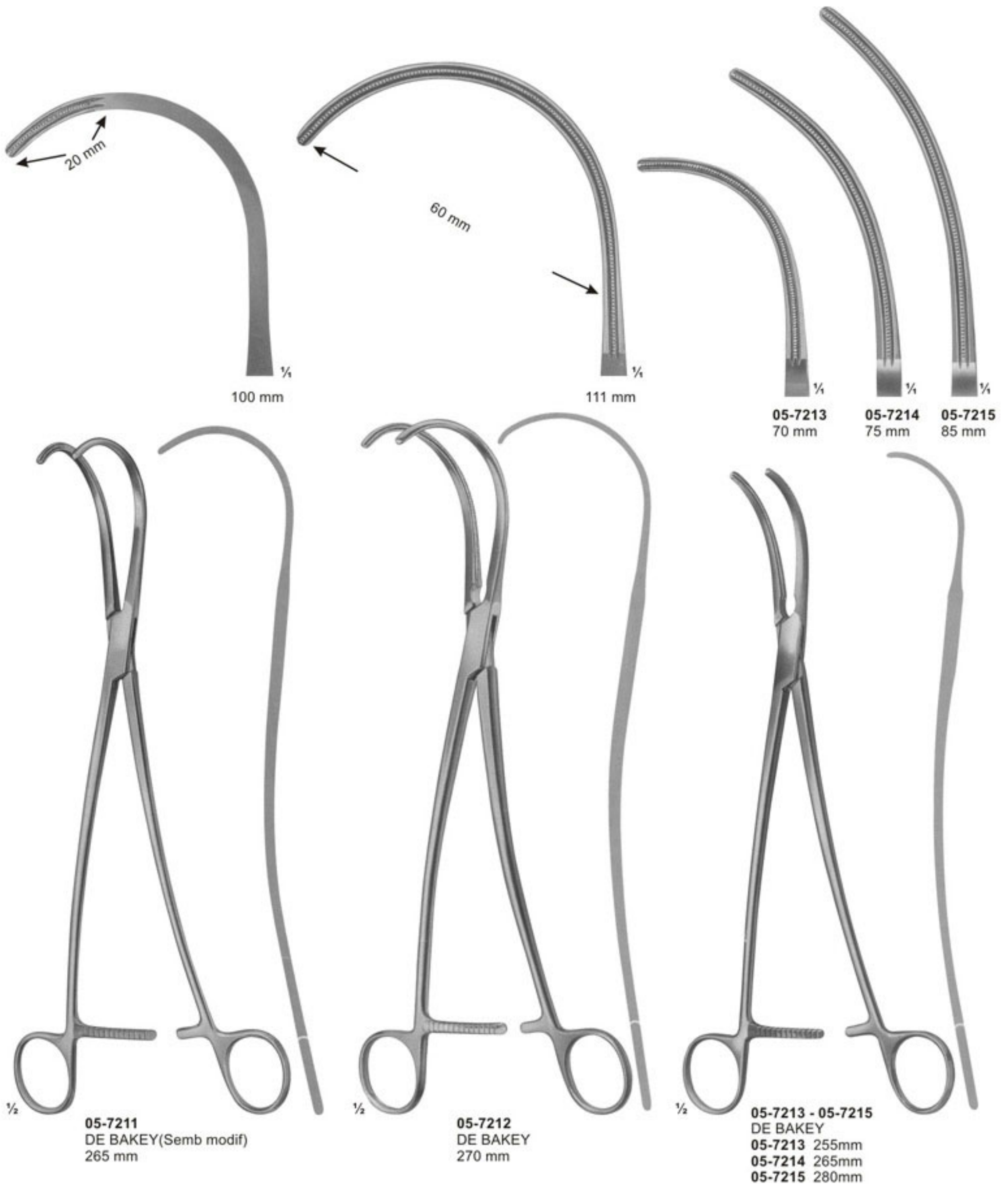





# Atraumata Aorta-Aneurysm Clamps

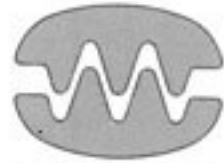

2.3 Teeth Rows



05-7216 05-7217 05-7218 05-7219  
95 mm 110 mm 130 mm 140 mm

05-7216 - 05-7219  
DE BAKEY  
05-7216 250mm  
05-7217 300mm  
07-7218 315mm  
07-7219 330mm



115 mm

05-7220  
DE BAKEY  
300 mm



# Atraumata Aorta Clamps



**05-7221**  
DIETRICH  
210 mm

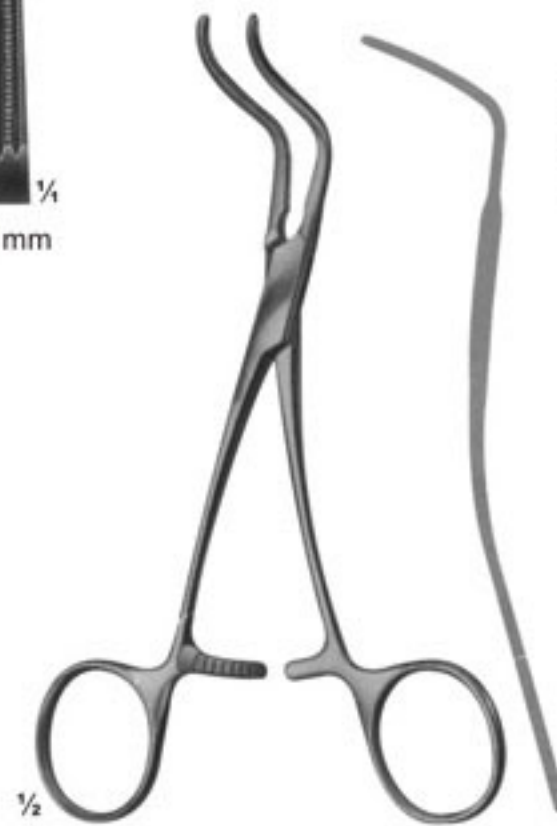

**05-7222**  
SUBRAMANIAN(Modif)  
155 mm





# Atraumata Aorta Clamps

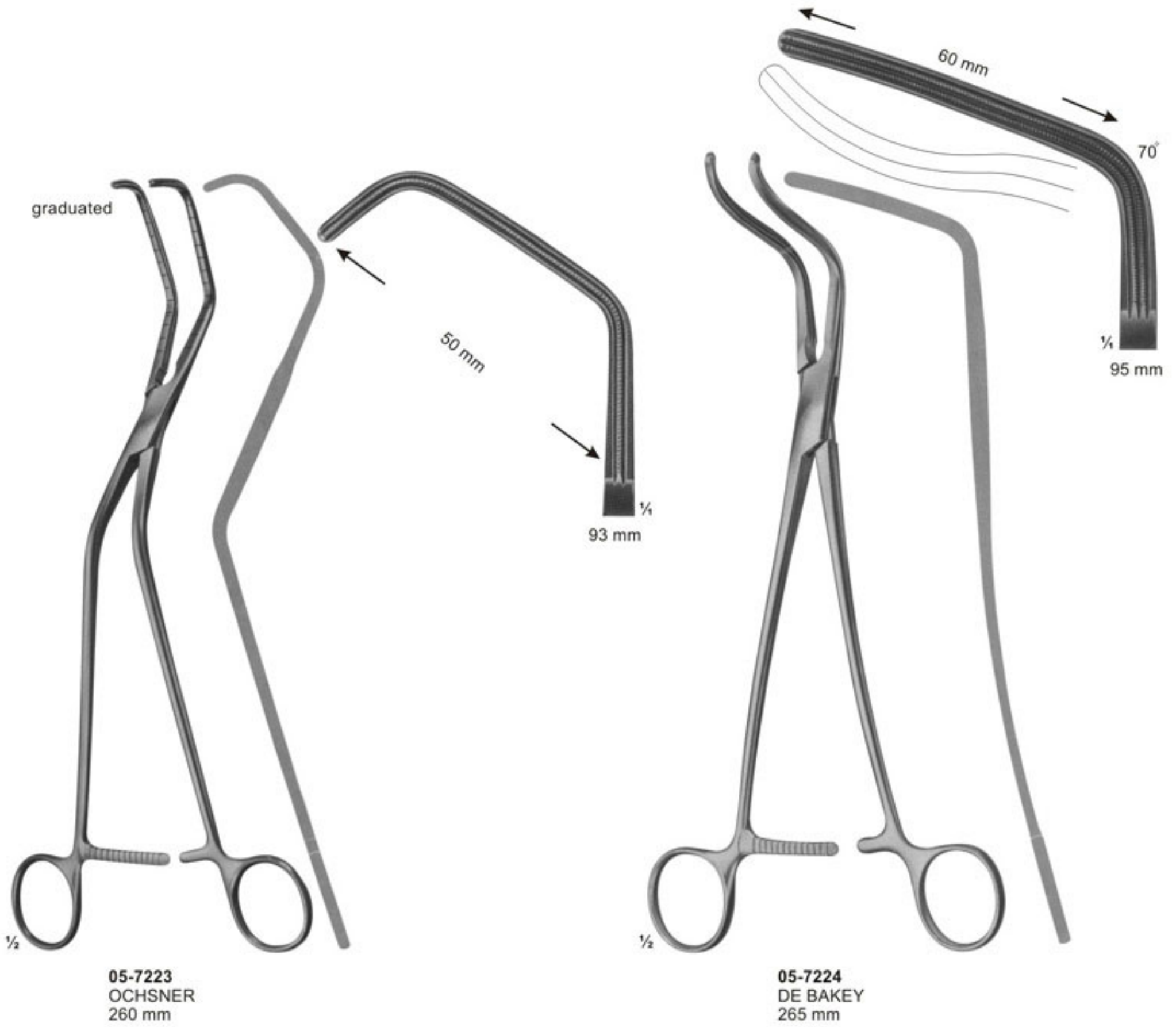



# Atraumata Aorta-Anastomosis Clamps



L  
05-7225  
WEBER  
260 mm



R  
05-7226  
WEBER  
260 mm





# Multi-Purpose Clamps



1/2 05-7227 - 05-7230  
DE BAKAY

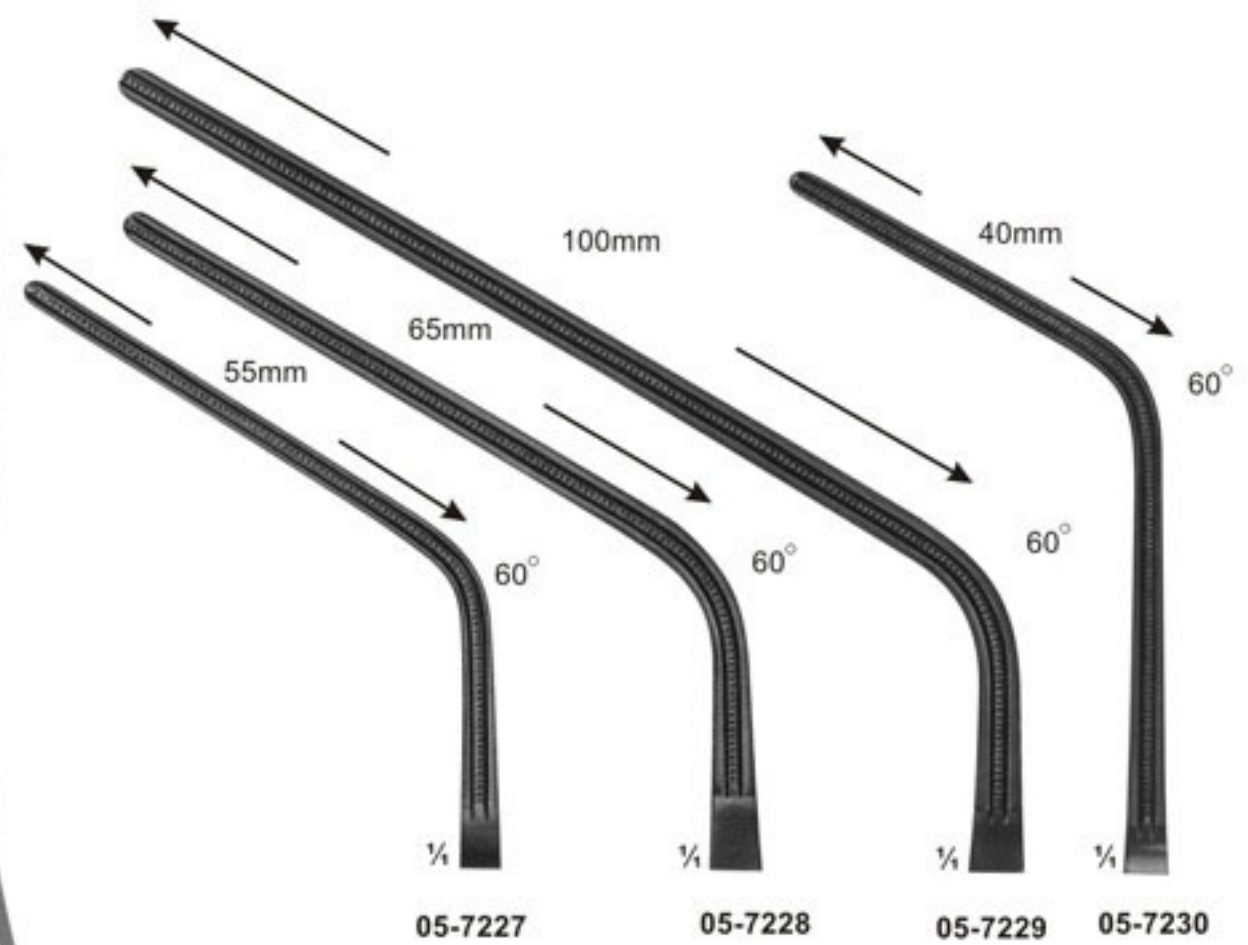

Total Length:	230 mm	280 mm	305 mm	240 mm
Length of jaws:	85 mm	100 mm	135 mm	93 mm



1/2 05-7231 - 05-7234  
DE BAKAY

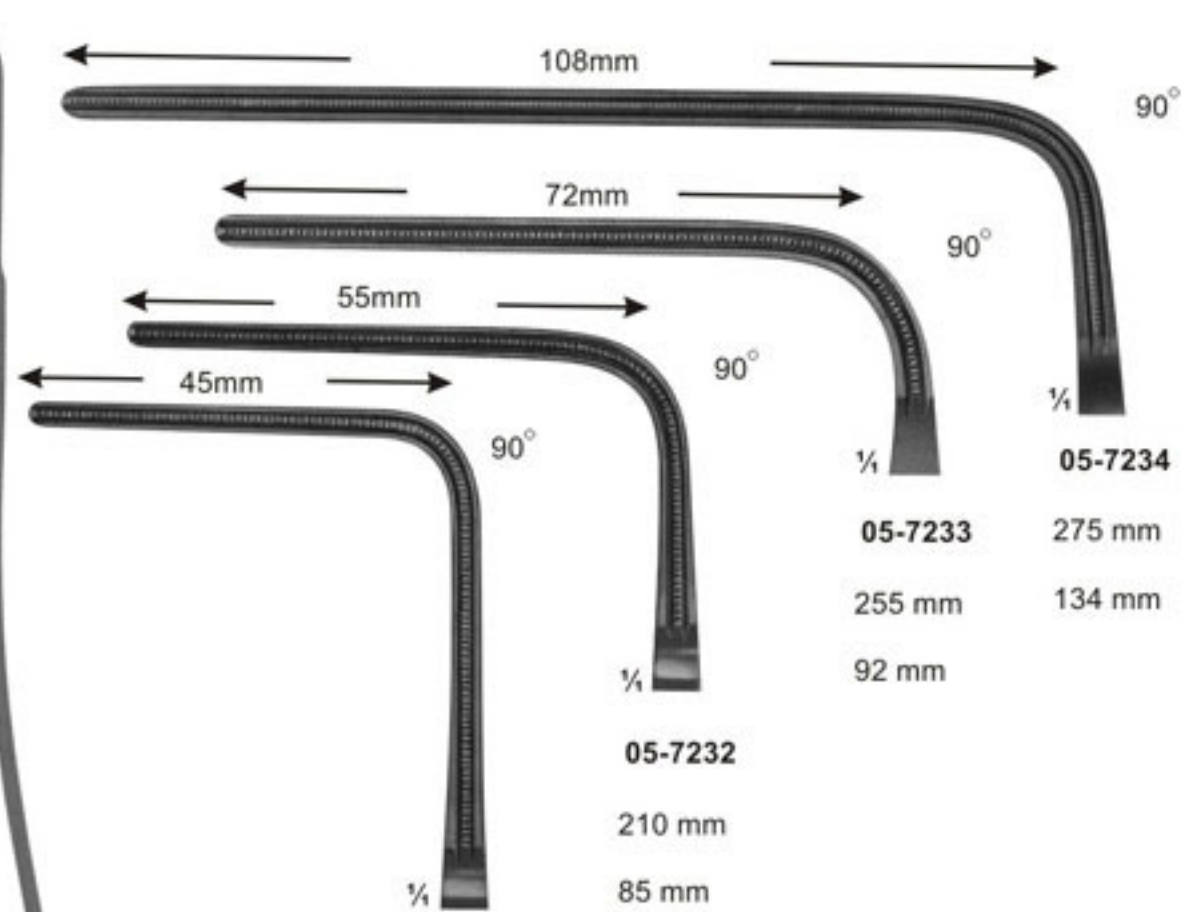

Total Length:	275 mm	255 mm	210 mm	225 mm
Length of jaws:	134 mm	92 mm	85 mm	93 mm



# Ring Handle Bulldog Clamps Anastomosis Clamps, Pediatric Types



05-7235  
50mm



05-7236  
50mm



05-7237  
COOLEY  
100 mm

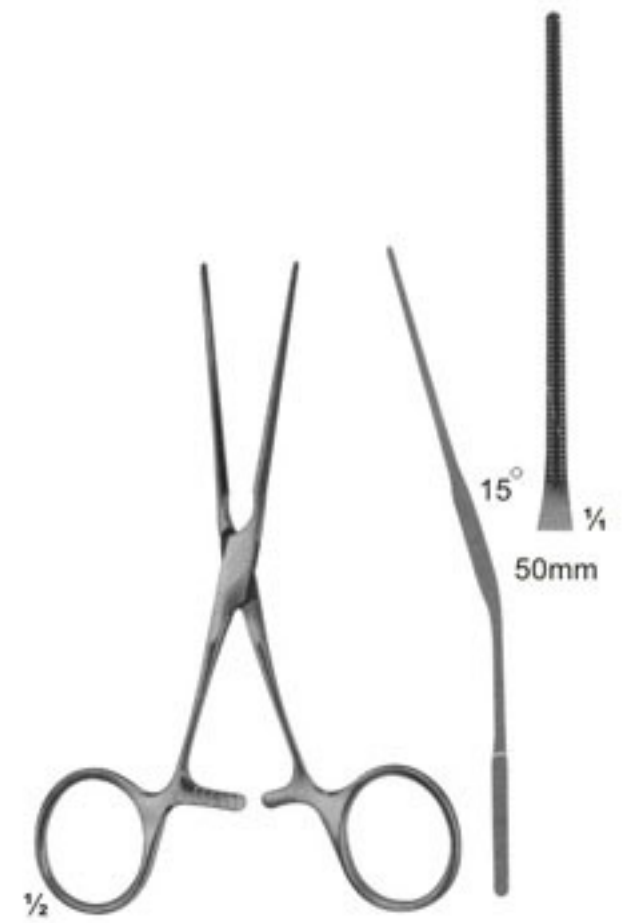

05-7238  
COOLEY  
125 mm

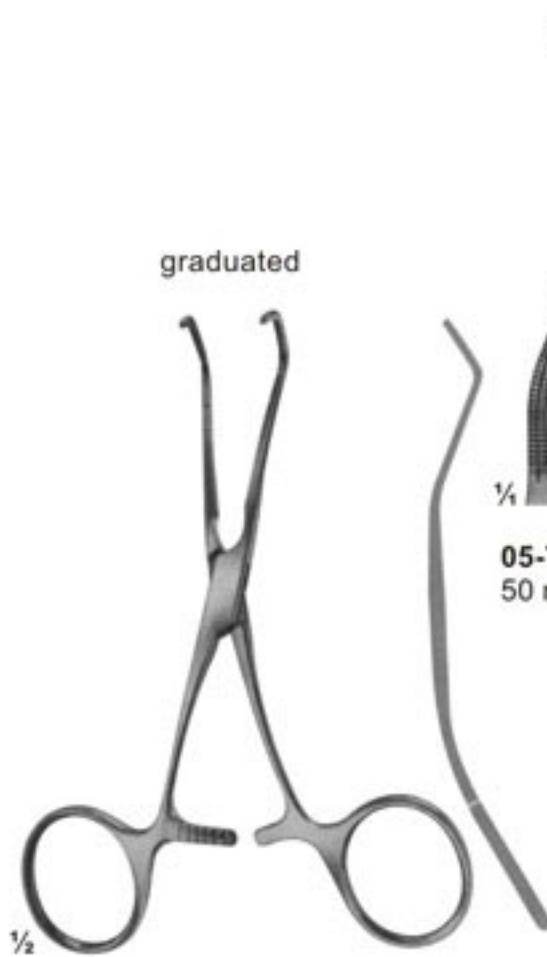

graduated

05-7239 - 05-7240  
COOLEY  
120 mm, 115 mm

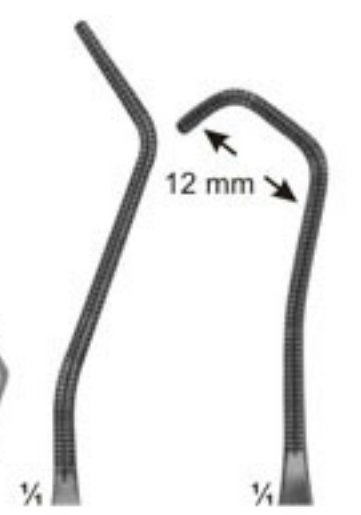

05-7239  
50 mm

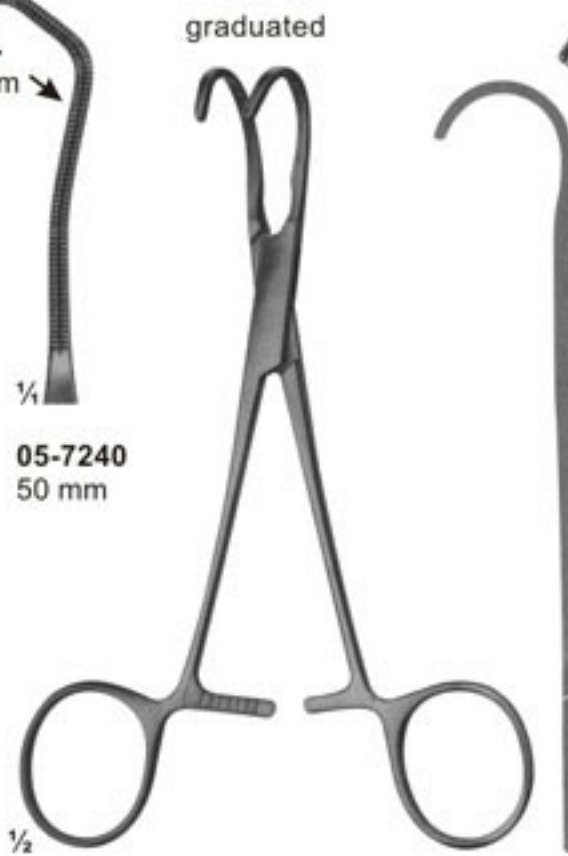

graduated

05-7241 - 05-7242  
COOLEY-BECK  
150 mm, 155 mm

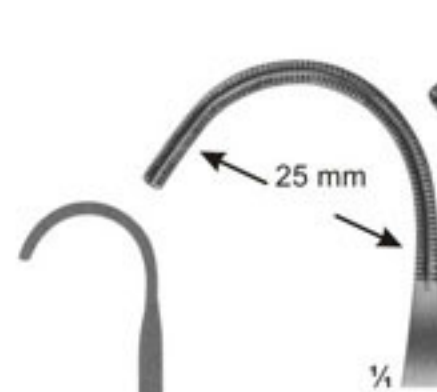

05-7241  
56 mm

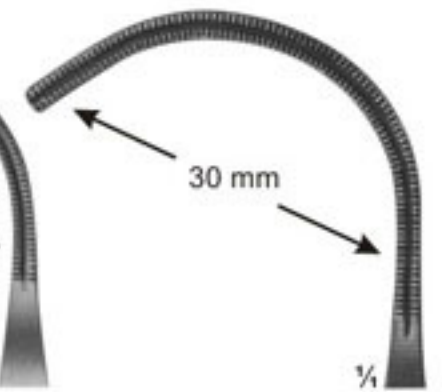

05-7242  
63 mm





# Anastomosis Clamps, Pediatric Types

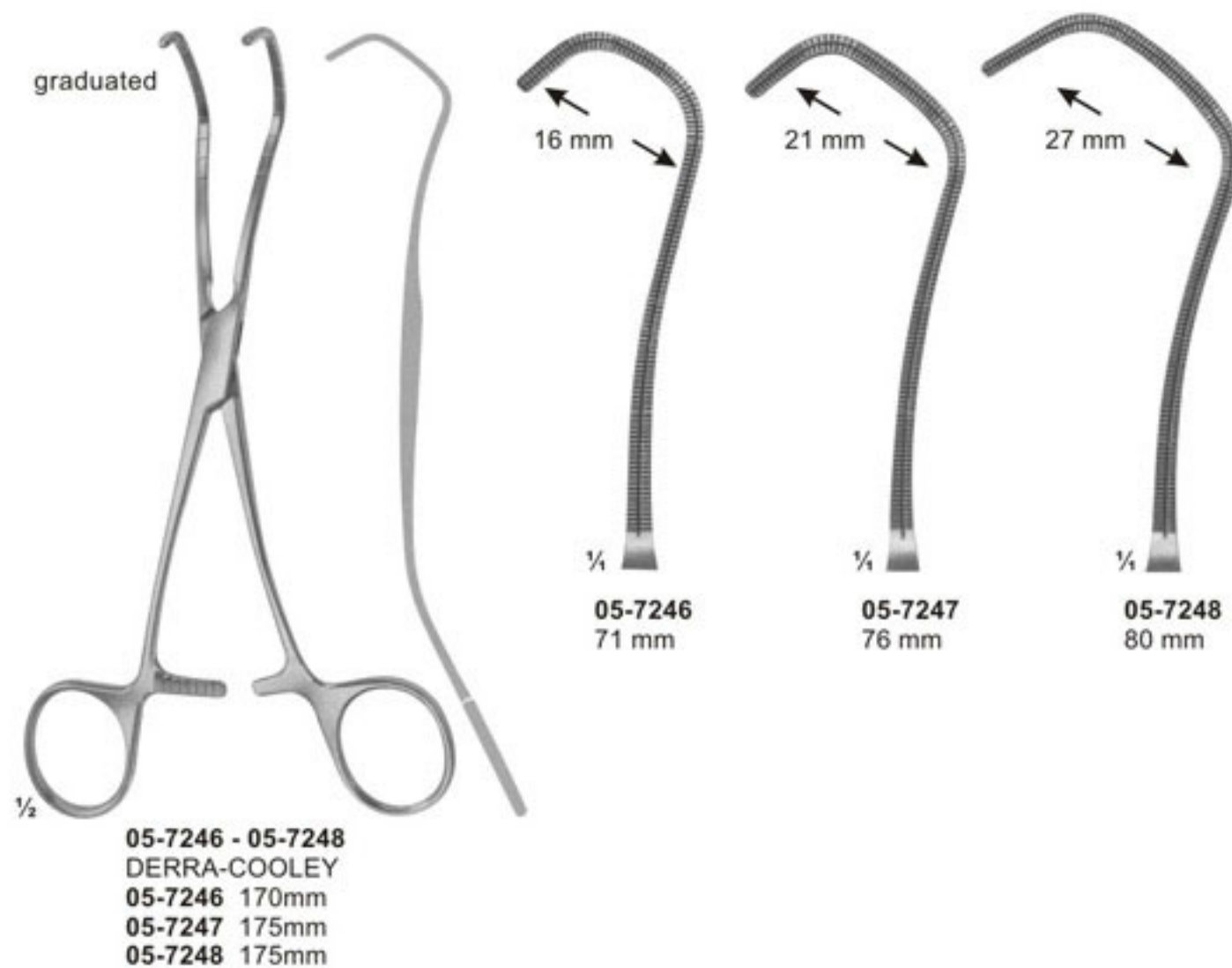
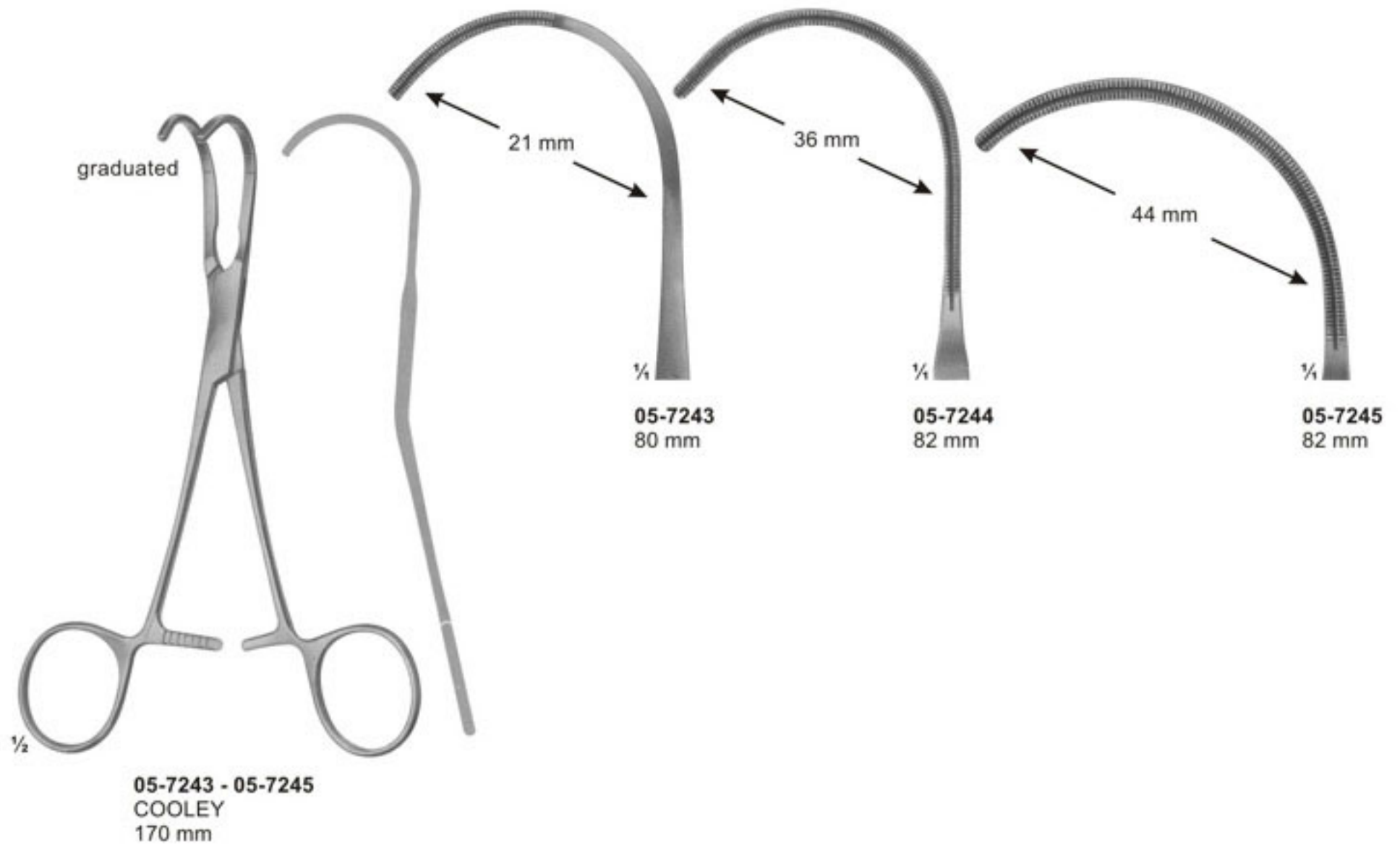



# Anastomosis Clamps Multi-Purpose Clamps Pediatric Types

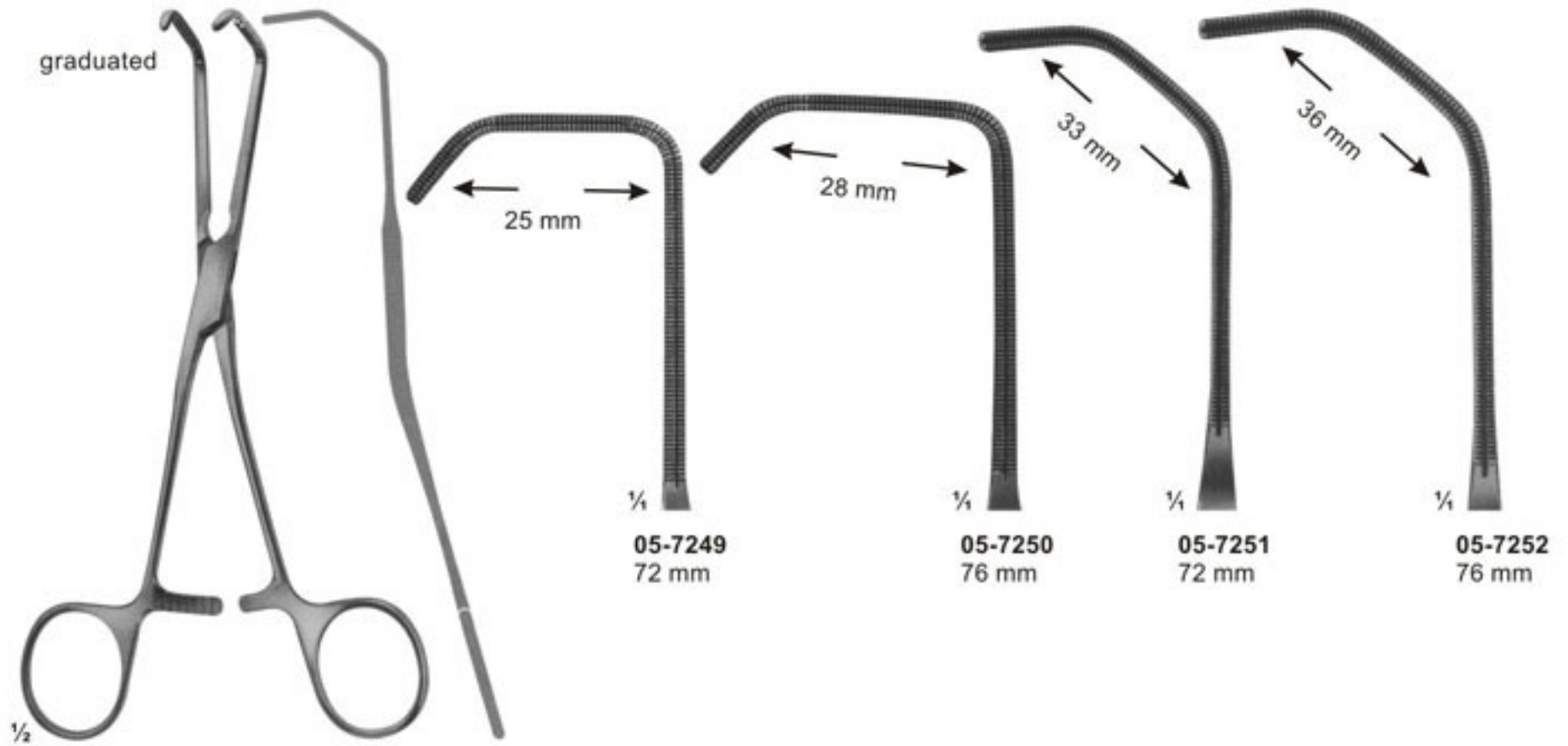

05-7249 - 05-7252  
COOLEY  
05-7249 165mm  
05-7250 165mm  
05-7251 175mm  
05-7252 180mm

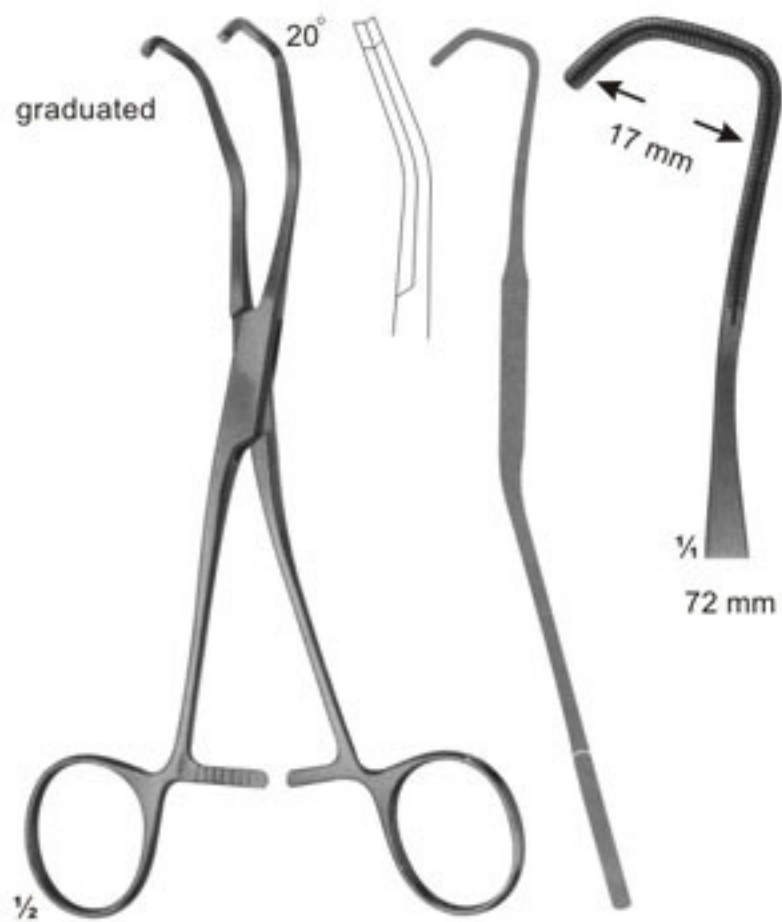

05-7253  
COOLEY  
170 mm

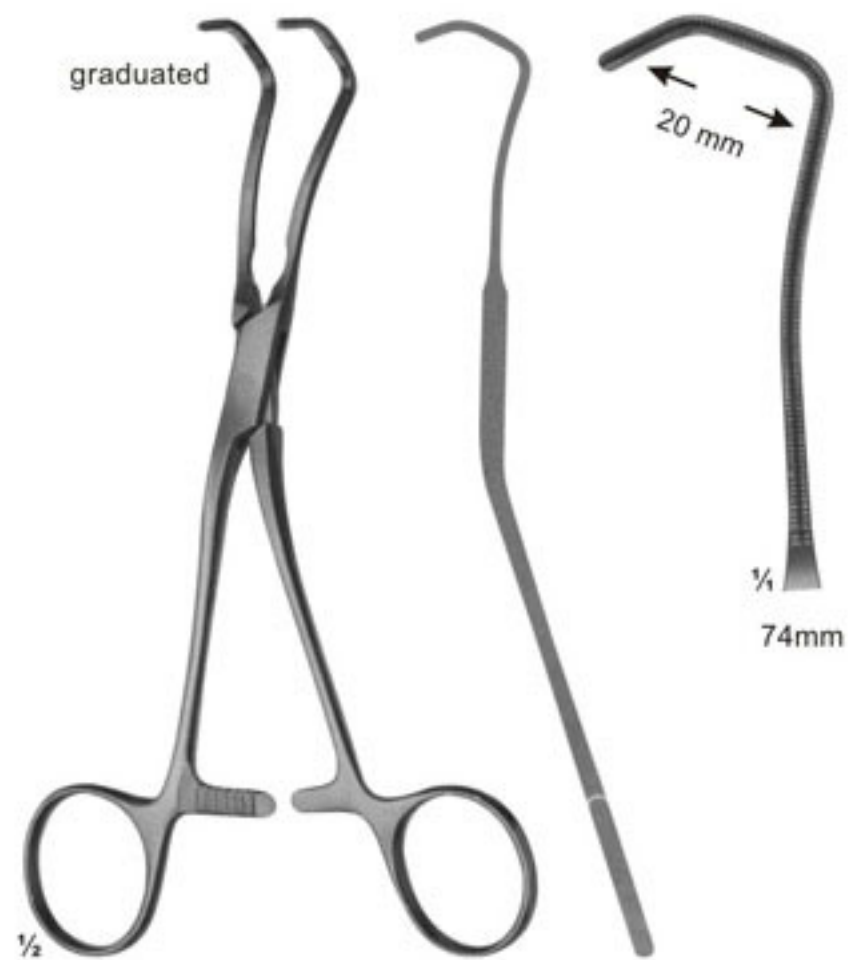

05-7254  
COOLEY  
175 mm





# Multi-Purpose Clamps, Pediatric Types

graduated

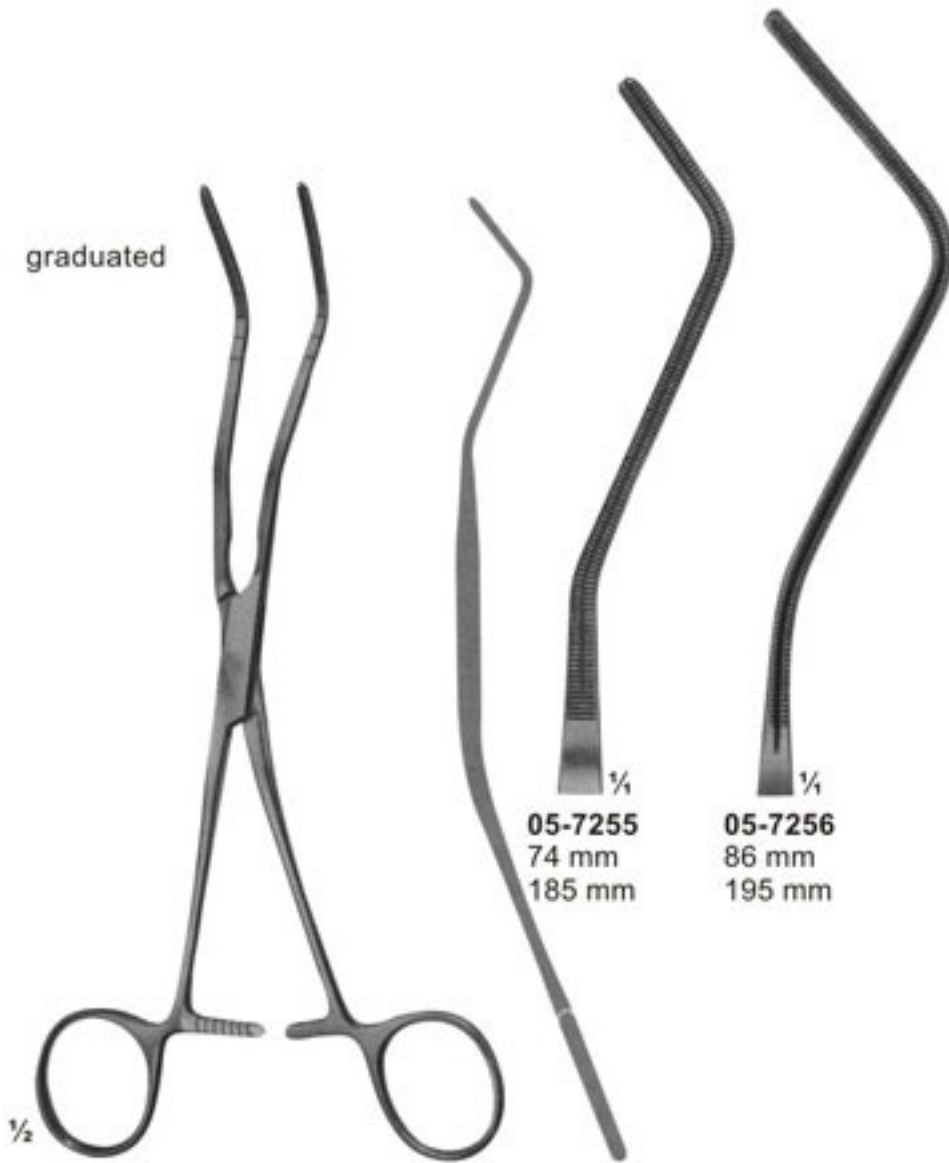

1/2

**05-7255 - 05-7256**  
COOLEY

05-7255  
74 mm  
185 mm

05-7256  
86 mm  
195 mm

graduated



1/2

**05-7257**  
COOLEY  
260 mm

graduated

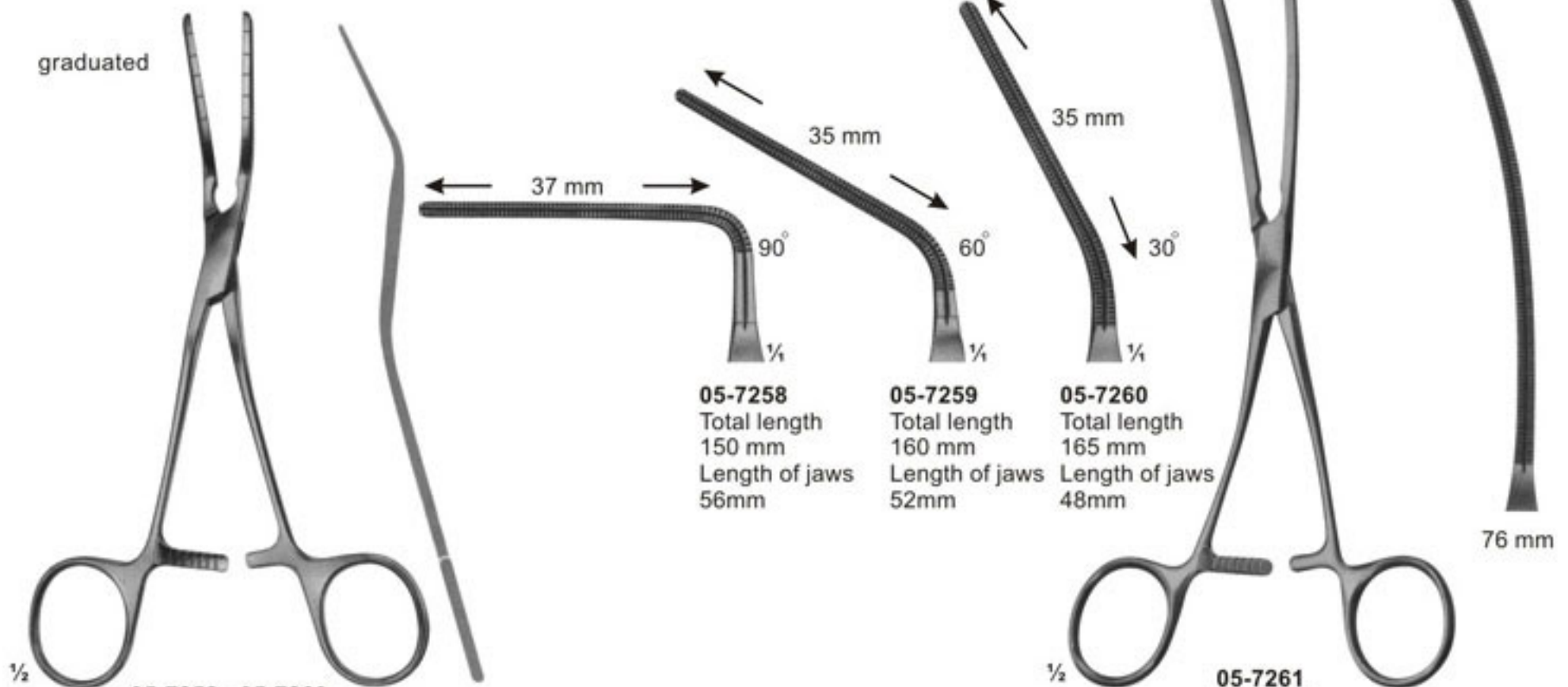

1/2

**05-7258 - 05-7260**  
COOLEY

05-7258  
Total length  
150 mm  
Length of jaws  
56mm

05-7259  
Total length  
160 mm  
Length of jaws  
52mm

05-7260  
Total length  
165 mm  
Length of jaws  
48mm

76 mm

**05-7261**  
COOLEY  
190 mm





# Atraumata Aorta Clamps, Patent-Ductus Clamps, Coarctation Clamps Pediatric Types

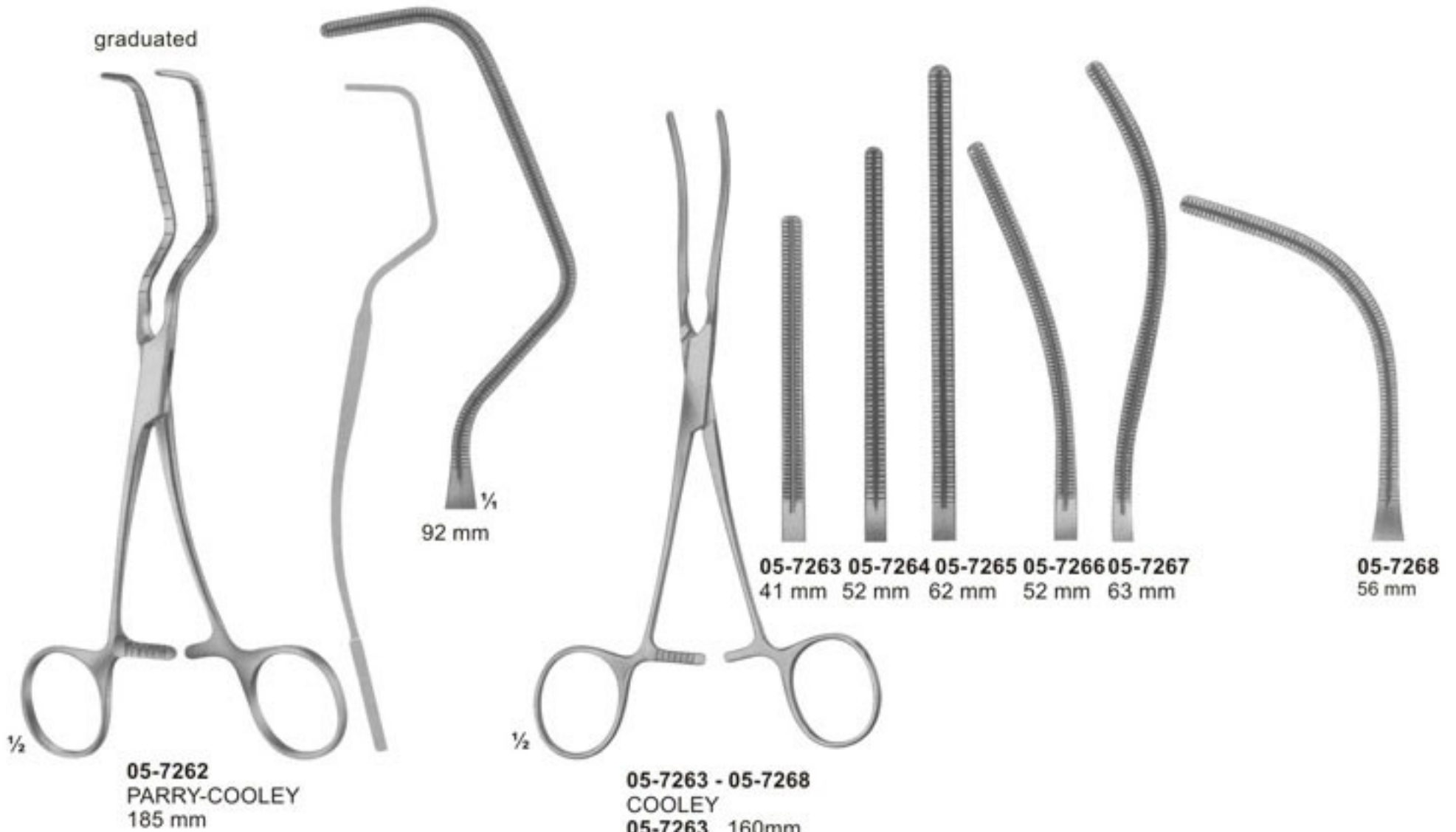

05-7263 05-7264 05-7265 05-7266 05-7267  
41 mm 52 mm 62 mm 52 mm 63 mm

05-7268  
56 mm

05-7262  
PARRY-COOLEY  
185 mm

05-7263 - 05-7268  
COOLEY  
05-7263 160mm  
05-7264 170mm  
05-7265 180mm  
05-7266 180mm  
05-7267 180mm  
05-7268 160mm

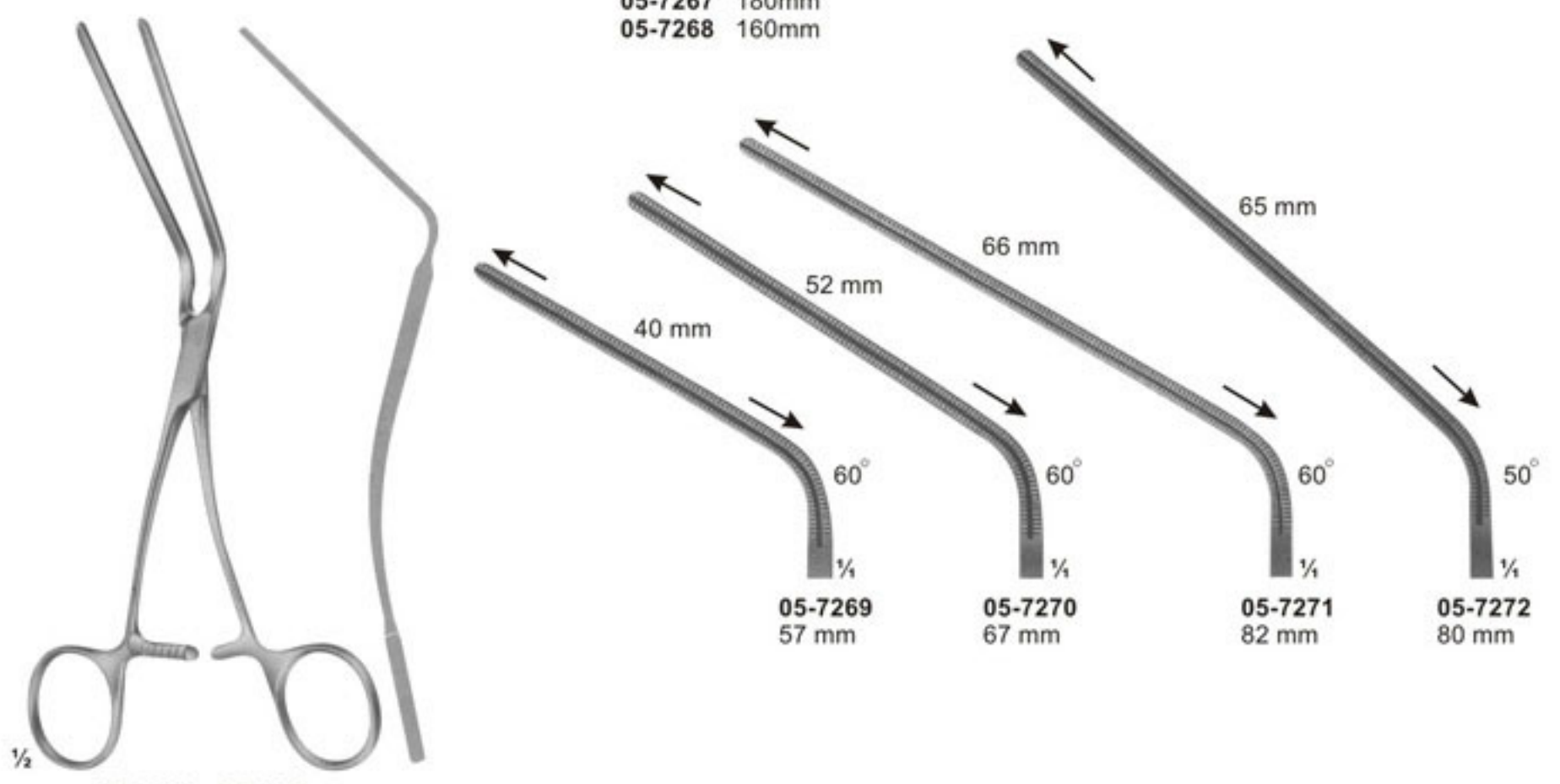

05-7269 - 05-7272  
05-7269 165mm  
05-7270 170mm  
05-7271 185mm  
05-7272 185mm

05-7269  
57 mm

05-7270  
67 mm

05-7271  
82 mm

05-7272  
80 mm





# Multi-Purpose Clamps



05-7273 - 05-7282

DARDIK

05-7273	150 mm	05-7278	170 mm
05-7274	150 mm	05-7279	170 mm
05-7275	150 mm	05-7280	170 mm
05-7276	145 mm	05-7281	160 mm
05-7277	130 mm	05-7282	135 mm

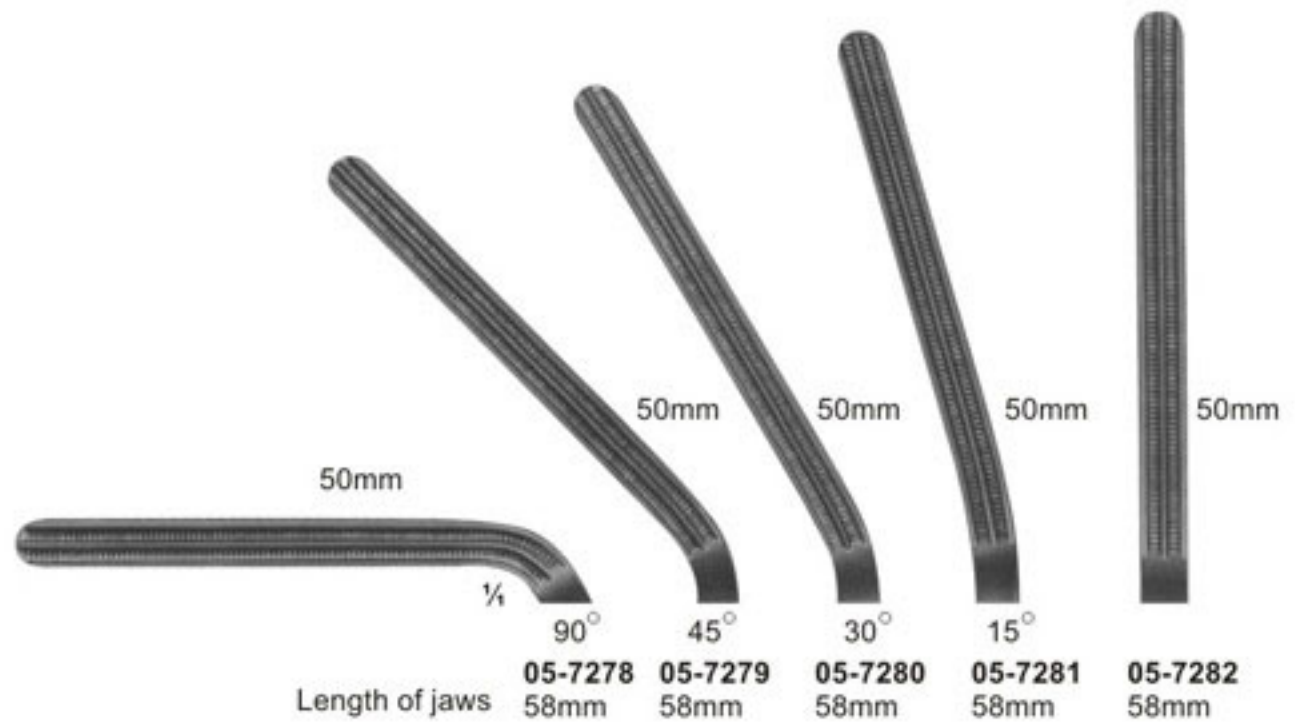
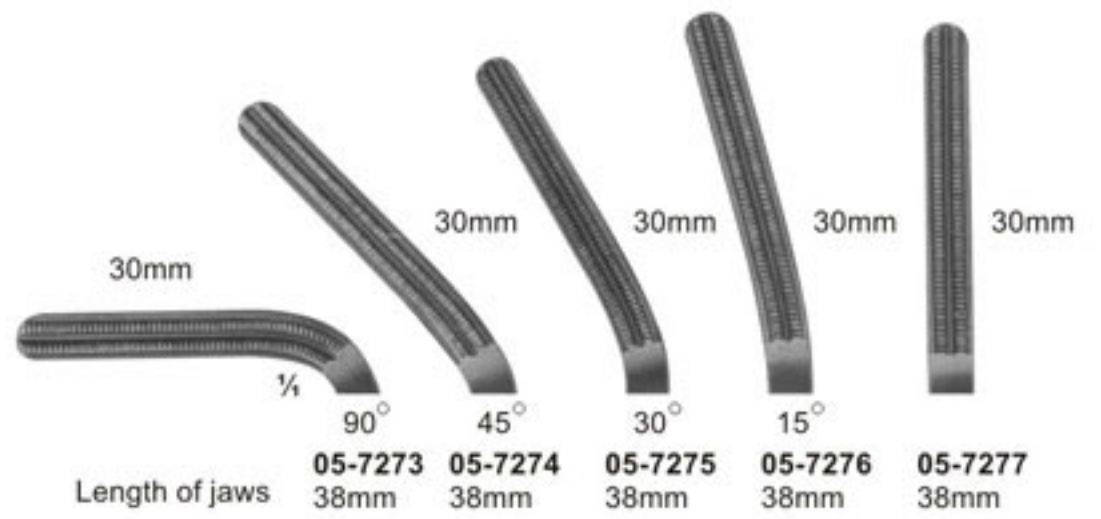



# Lung Grasping Forceps



**05-7283**  
WILLIAMS  
160 mm



**05-7284**  
TUTTLE  
230 mm



**05-7285**  
NELSON  
230 mm



**05-7286**  
DUVAL  
230 mm



**05-7287**

**05-7288**

**05-7289**



**05-7287 - 05-7289**  
BABCOCK  
**05-7287** 170 mm  
**05-7288** 215 mm  
**05-7289** 220 mm

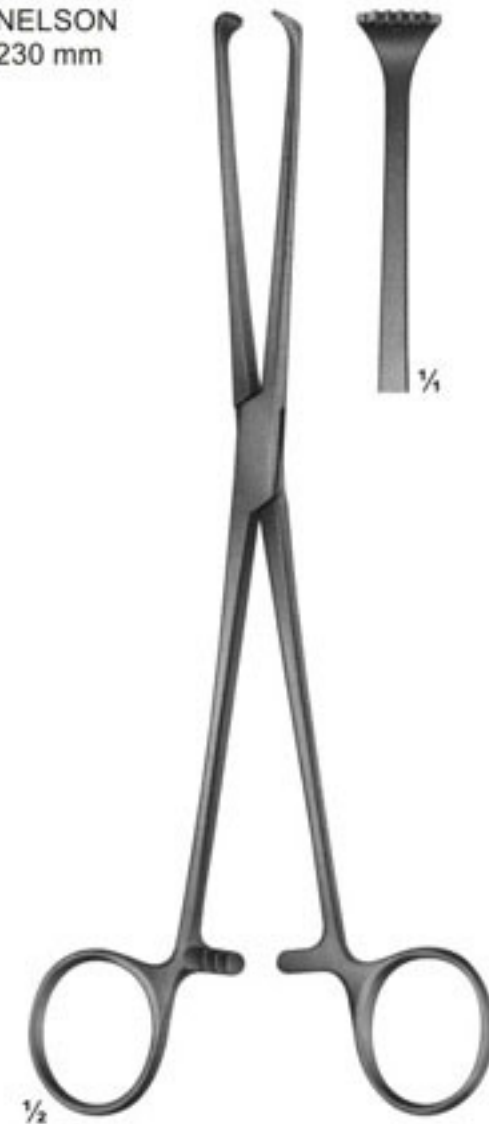

**05-7290**  
ALLIS  
220 mm





# Dissecting And Ligature Forceps

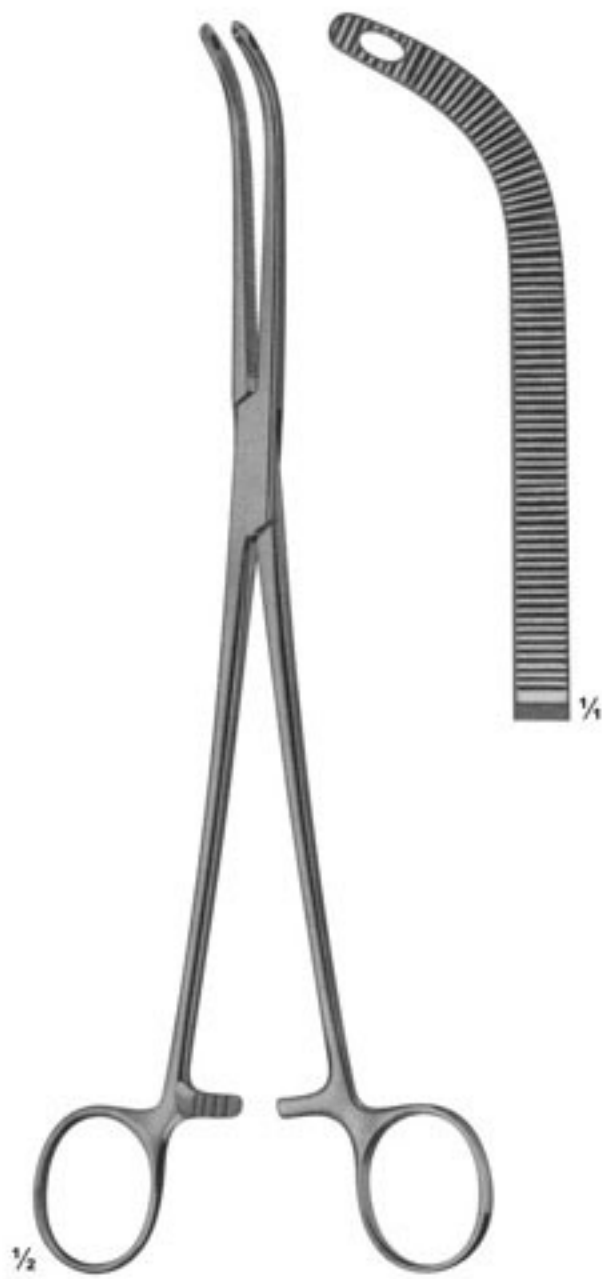

**05-7291**  
FINOCHIETTO  
245 mm

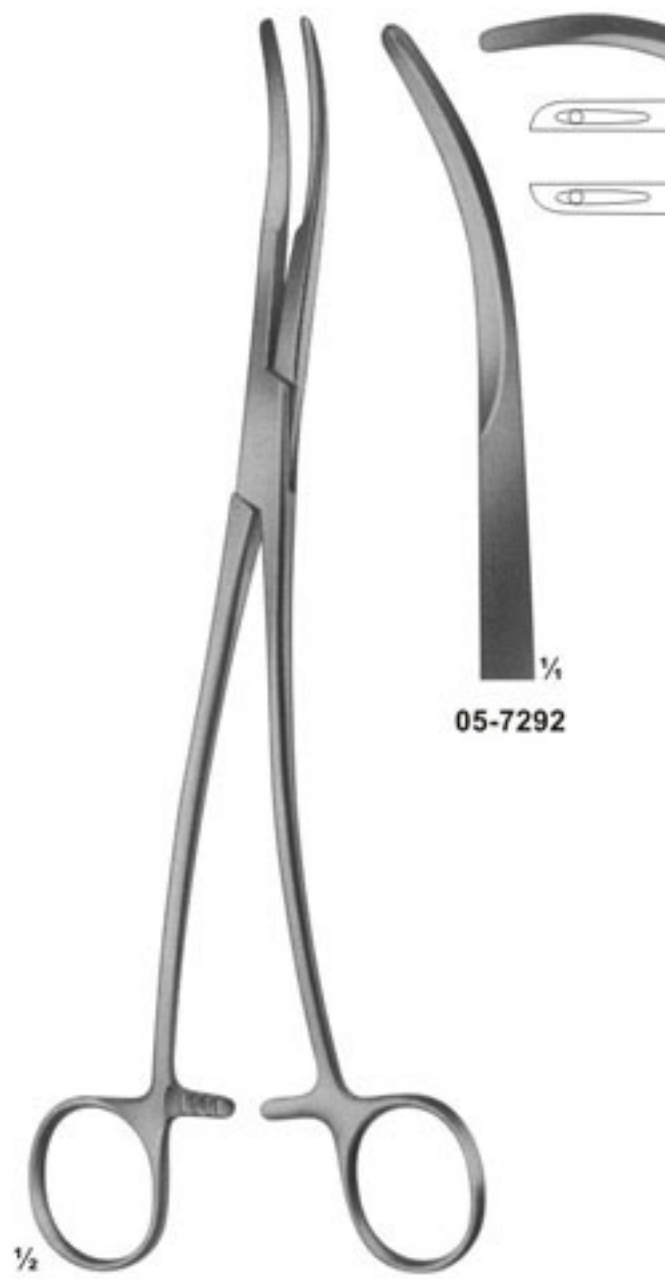

**05-7292 - 05-7293**  
SEMB  
240 mm

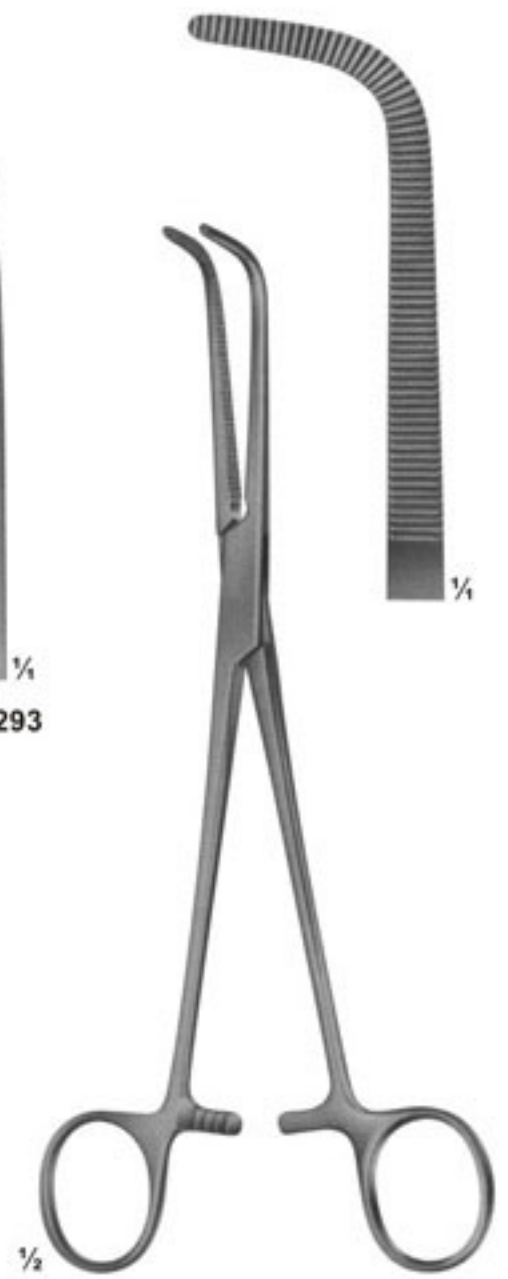

**05-7294**  
WIKSTROEM  
205 mm



# Dissecting And Ligature Forceps, Vessel Clamps



**05-7295**  
MIXTER  
230 mm

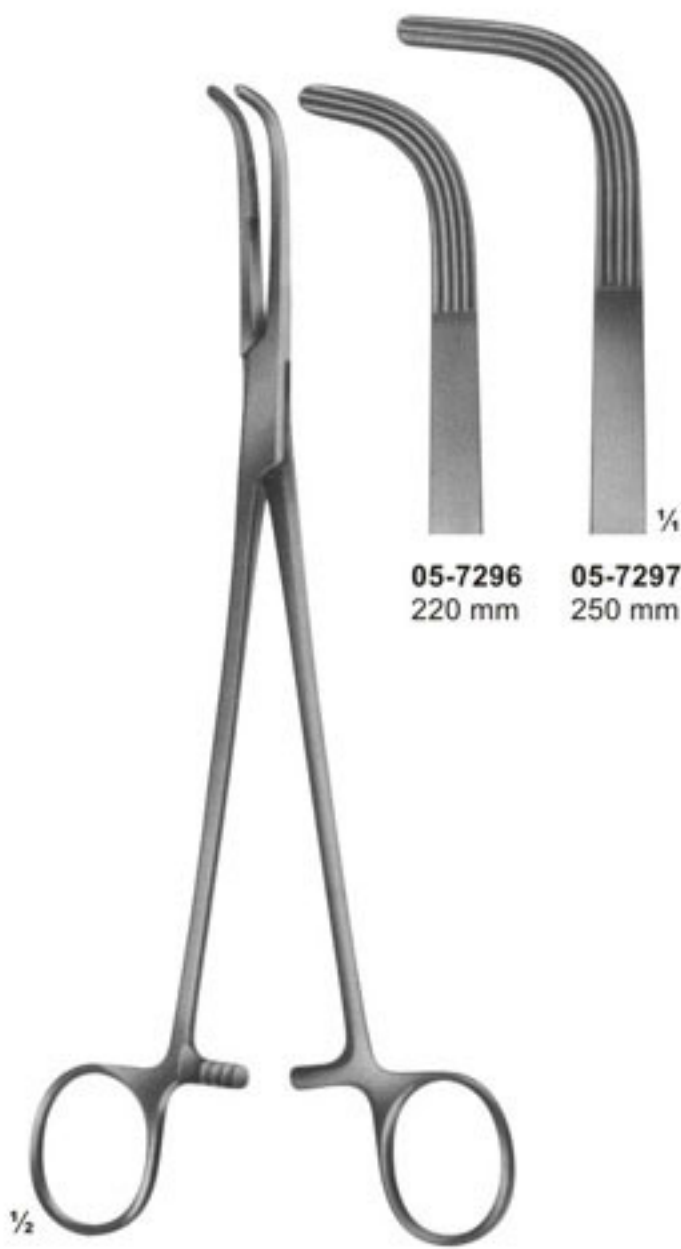

**05-7296** 220 mm  
**05-7297** 250 mm

**05-7296 - 05-7297**  
MIXTER

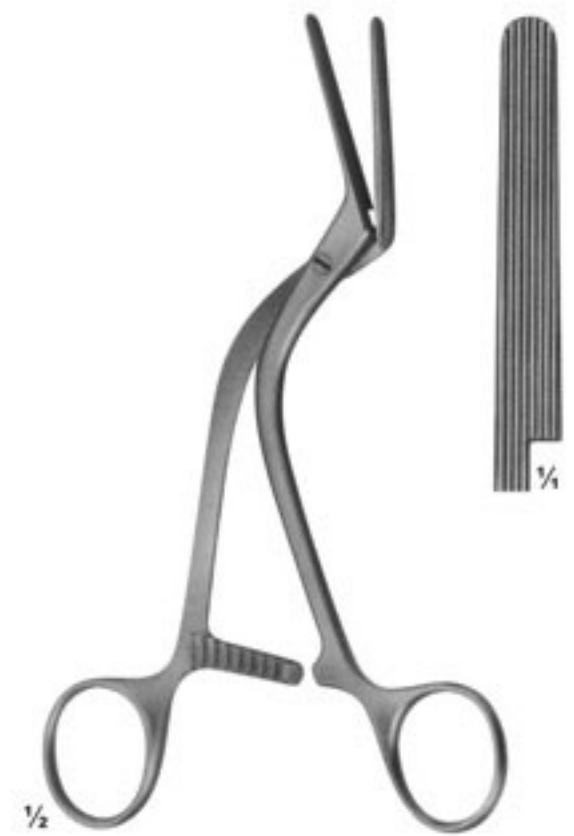

**05-7298**  
HOEPFNER  
Vessel clamp  
160 mm





# Vena Cava Clamps

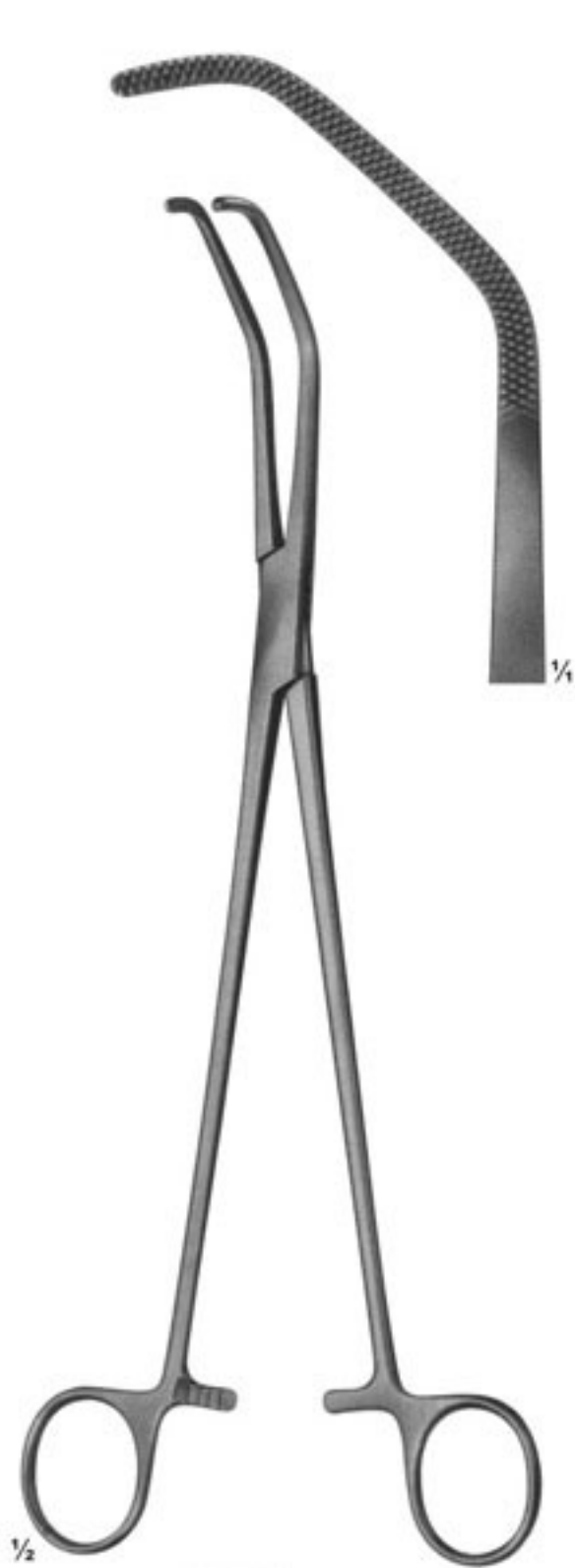

**05-7299**  
SATINSKY  
Anastomosis clamps  
265 mm

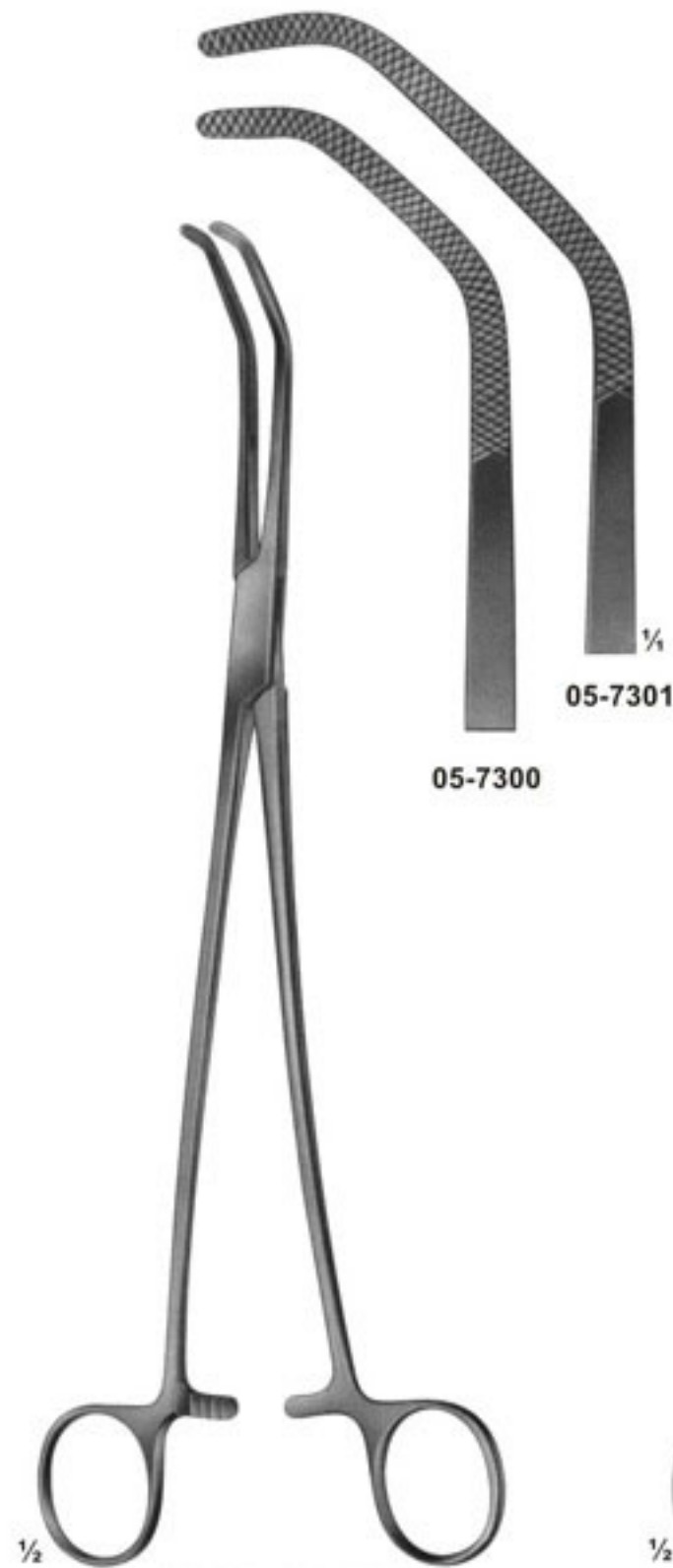

**05-7300 - 05-7301**  
SATINSKY  
Anastomosis clamps  
265 mm

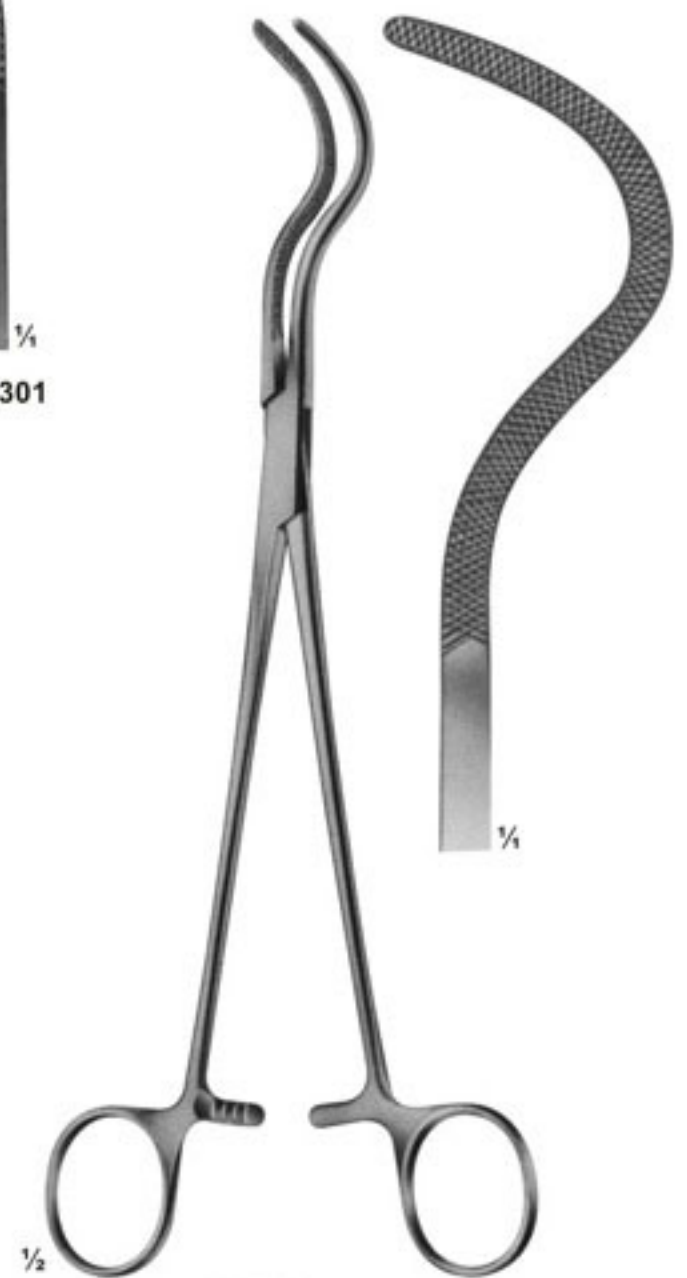

**05-7302**  
HARKEN  
240 mm



# Carotid Clamps, Auricle Clamps



$\frac{1}{2}$   
**05-7303**  
PERTUISET  
Carotid Clamp  
90 mm

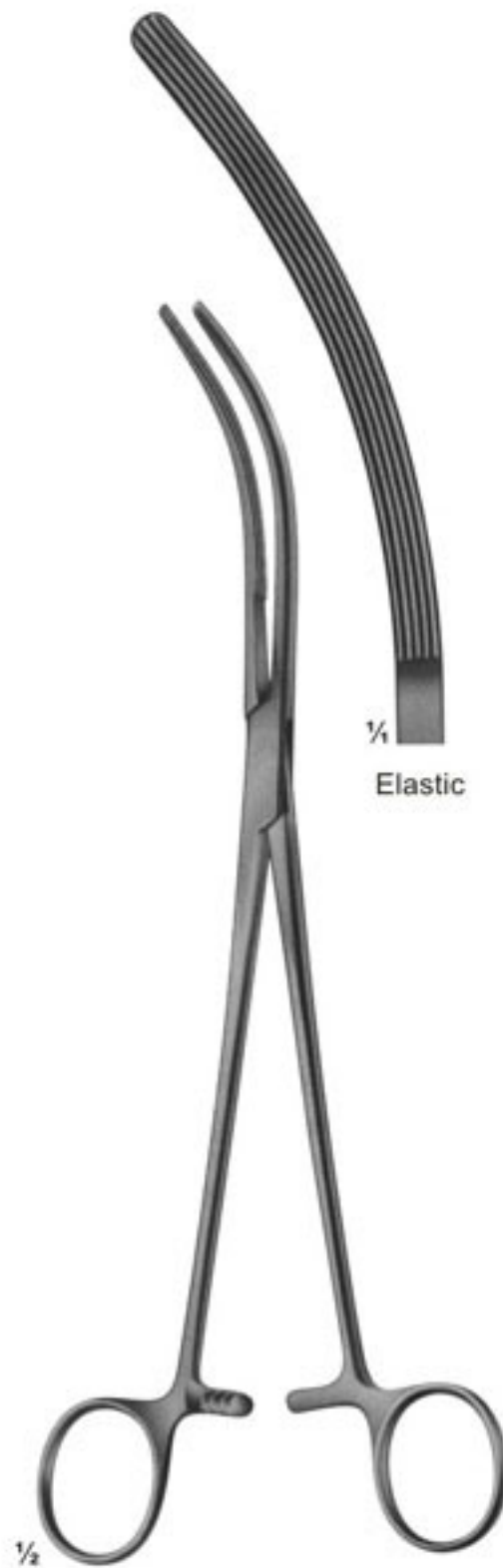

$\frac{1}{2}$   
**05-7304**  
CRAFOORD-SELLORS  
240 mm

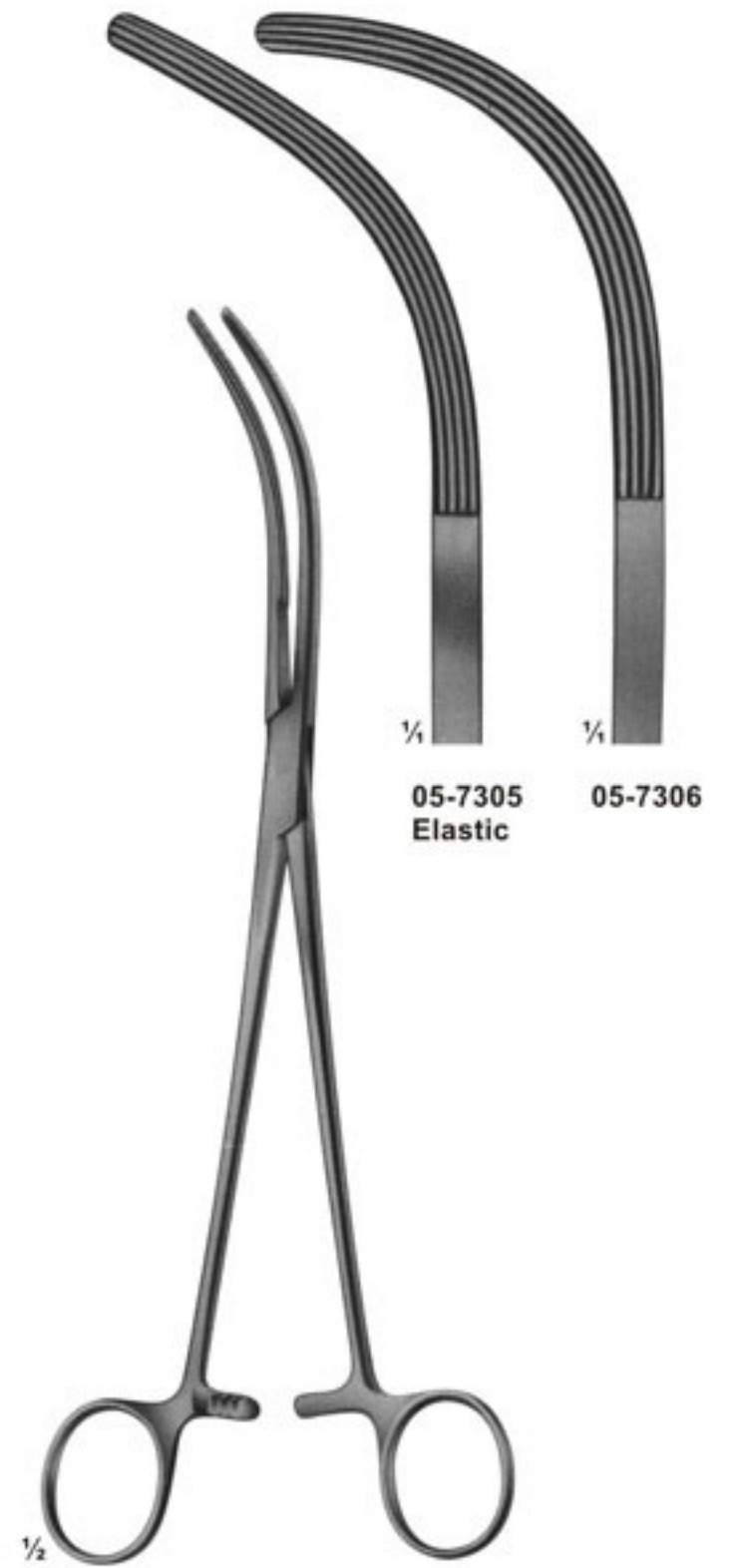

$\frac{1}{2}$   
**05-7305 - 05-7306**  
CRAFOORD  
240 mm





# Bronchus Forceps



**05-7307**  
PRICE THOMAS  
225 mm



**05-7308 - 05-7309**  
PRICE THOMAS  
225 mm



**05-7308**  
jaws with pins



**05-7309**  
jaws with pins



# Sternum Instruments And Rib Shears



05-7310  
SCHUMACHER  
Sternum shears  
210 mm



05-7311  
LEBSCHKE  
Sternum chisel  
200 mm



05-7312  
230 mm



05-7313  
COLLIN  
195 mm



05-7314  
GLUCK  
190 mm



05-7315  
BETHUNE  
340 mm



05-7316  
BRUNNER  
Universal Pattern  
340 mm



05-7317  
GIERTZ-STILLE  
250 mm





# Rib Holding Forceps, Bone Cutting Forceps, Rib Rongeurs

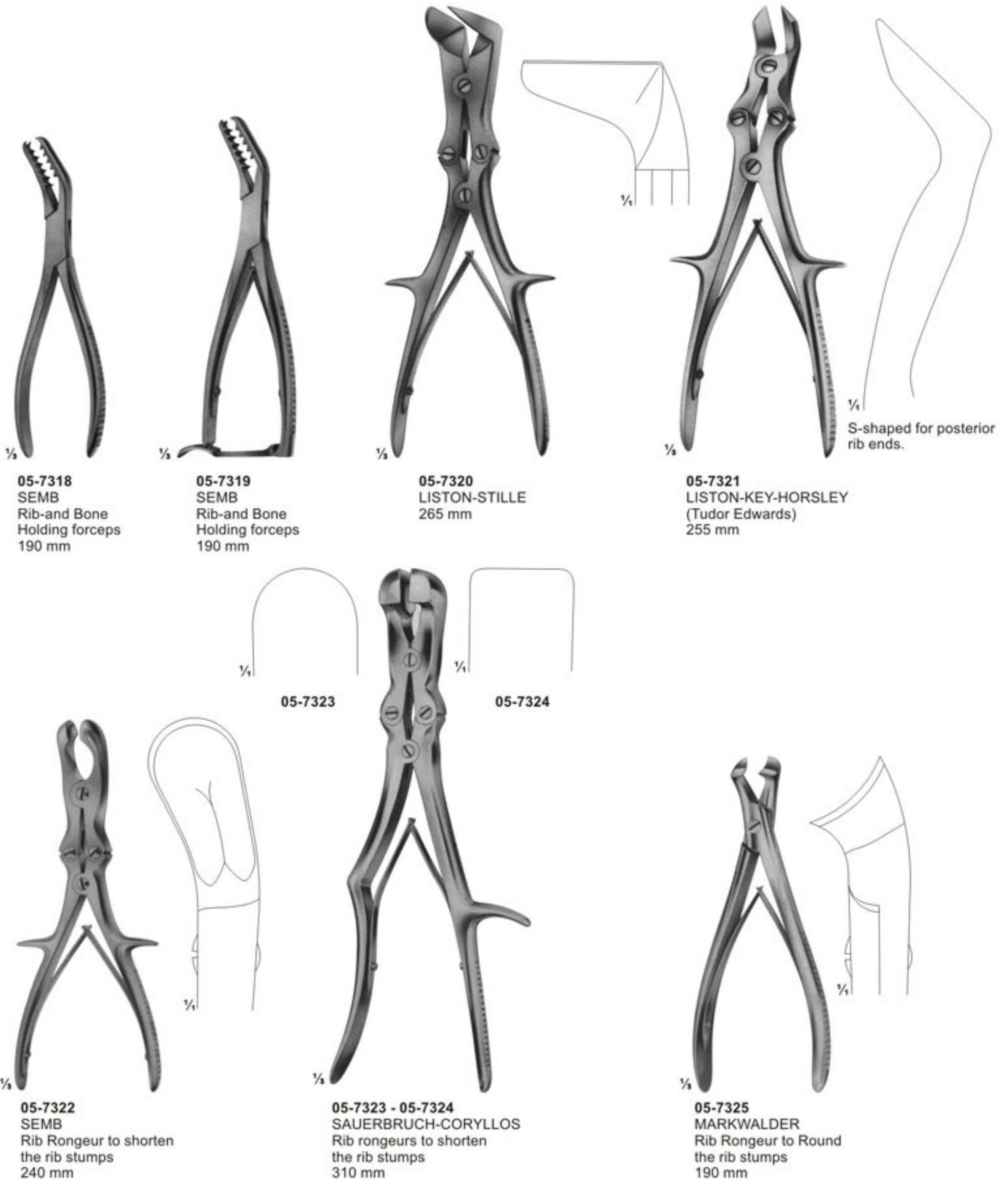

**05-7318**  
SEMB  
Rib-and Bone  
Holding forceps  
190 mm

**05-7319**  
SEMB  
Rib-and Bone  
Holding forceps  
190 mm

**05-7320**  
LISTON-STILLE  
265 mm

**05-7321**  
LISTON-KEY-HORSLEY  
(Tudor Edwards)  
255 mm

**05-7323**

**05-7324**

**05-7322**  
SEMB  
Rib Rongeur to shorten  
the rib stumps  
240 mm

**05-7323 - 05-7324**  
SAUERBRUCH-CORYLLOS  
Rib rongeurs to shorten  
the rib stumps  
310 mm

**05-7325**  
MARKWALDER  
Rib Rongeur to Round  
the rib stumps  
190 mm



# Rib Raspatories



05-7326 - 05-7327  
DOYEN  
for children  
175 mm

05-7328 - 05-7329  
DOYEN  
for adults  
175 mm

05-7330 - 05-7331  
DOYEN  
240 mm





# Rib Raspatories



1/2  
05-7332 - 05-7336  
SEMB  
230 mm



12 mm  
05-7332  
190 mm



12 mm  
05-7333  
230mm

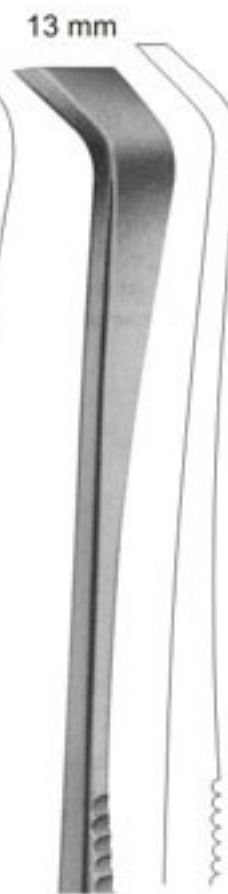

13 mm  
05-7334  
230mm



13 mm  
05-7335  
230mm



15 mm  
05-7336  
230mm

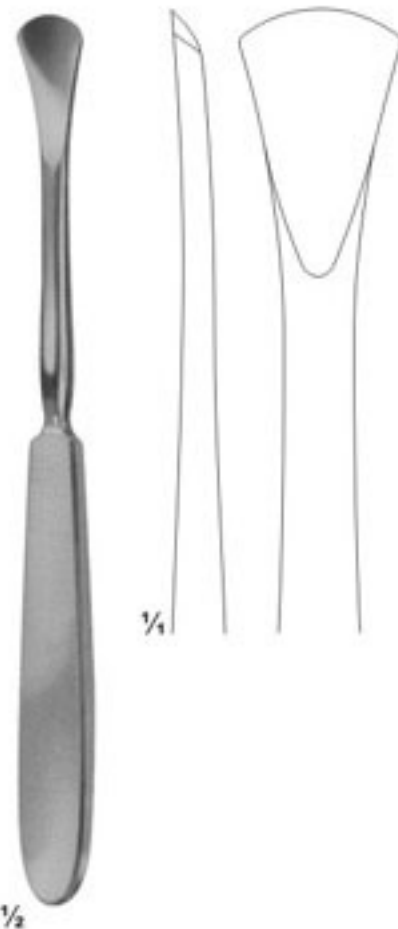

1/2  
05-7337  
LANGENBECK  
190 mm



1/2  
05-7338 - 05-7342  
LAMBOTTE  
215 mm

- 05-7338 5 mm
- 05-7339 10 mm
- 05-7340 15 mm
- 05-7341 20 mm
- 05-7342 25 mm

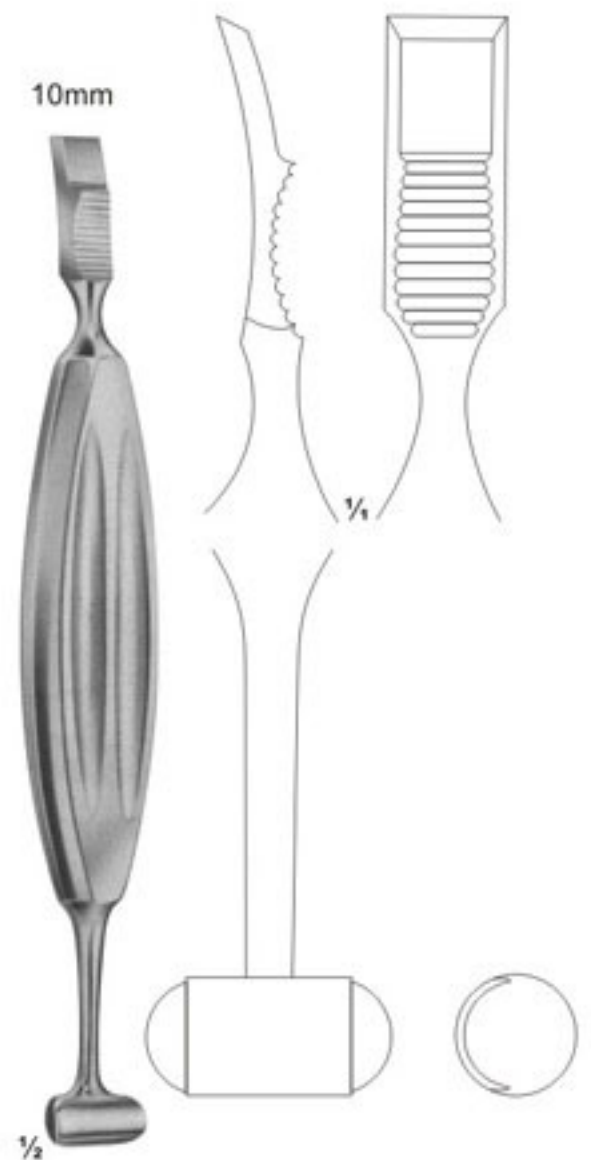

10mm  
1/2  
05-7343  
ALEXANDER  
210 mm



# Rib Spreaders



**05-7344**  
FINOCHIETTO  
Blades  
18X21 mm



**05-7345**  
HERTZLER  
Blades  
20X25 mm

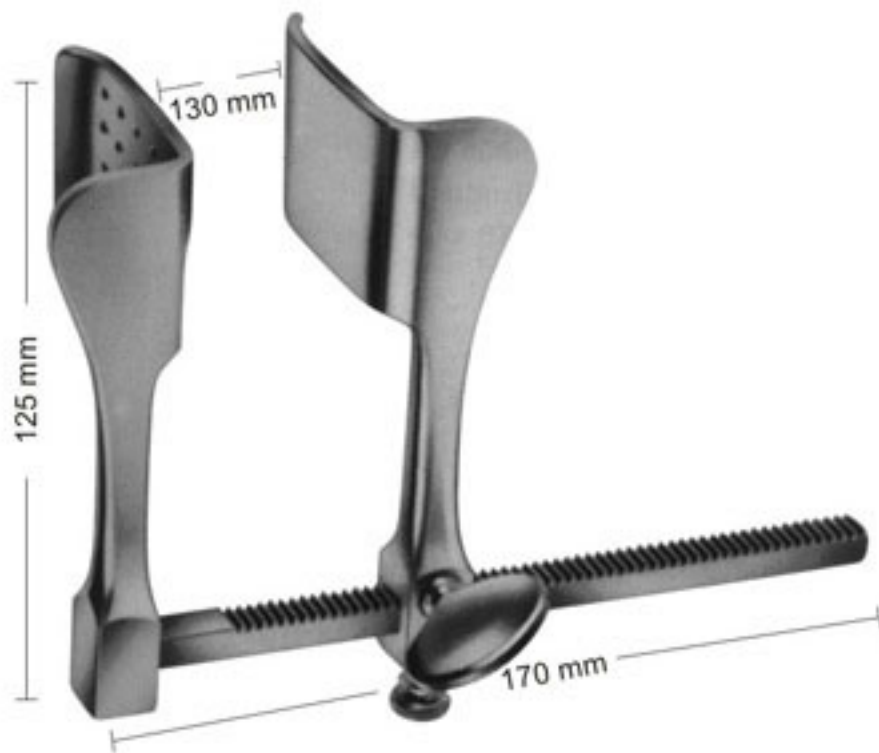

**05-7346**  
TUFFIER  
Blades  
43X53 mm

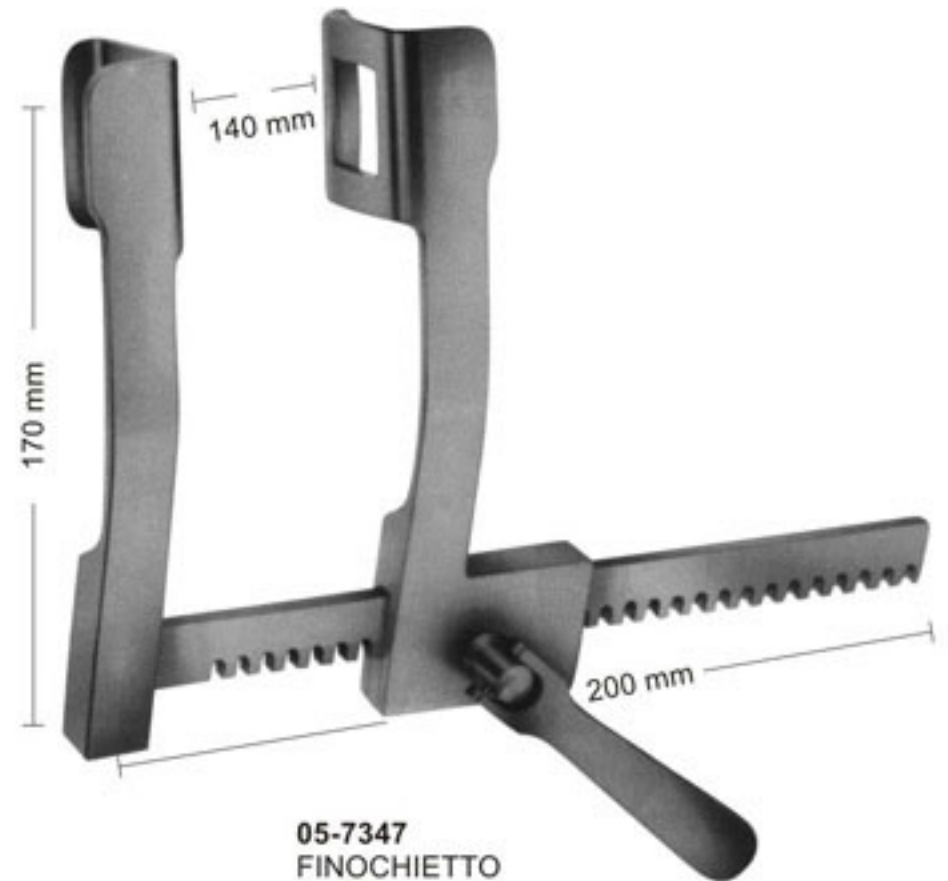

**05-7347**  
FINOCHIETTO  
Blades  
36X45 mm





# Rib Spreaders

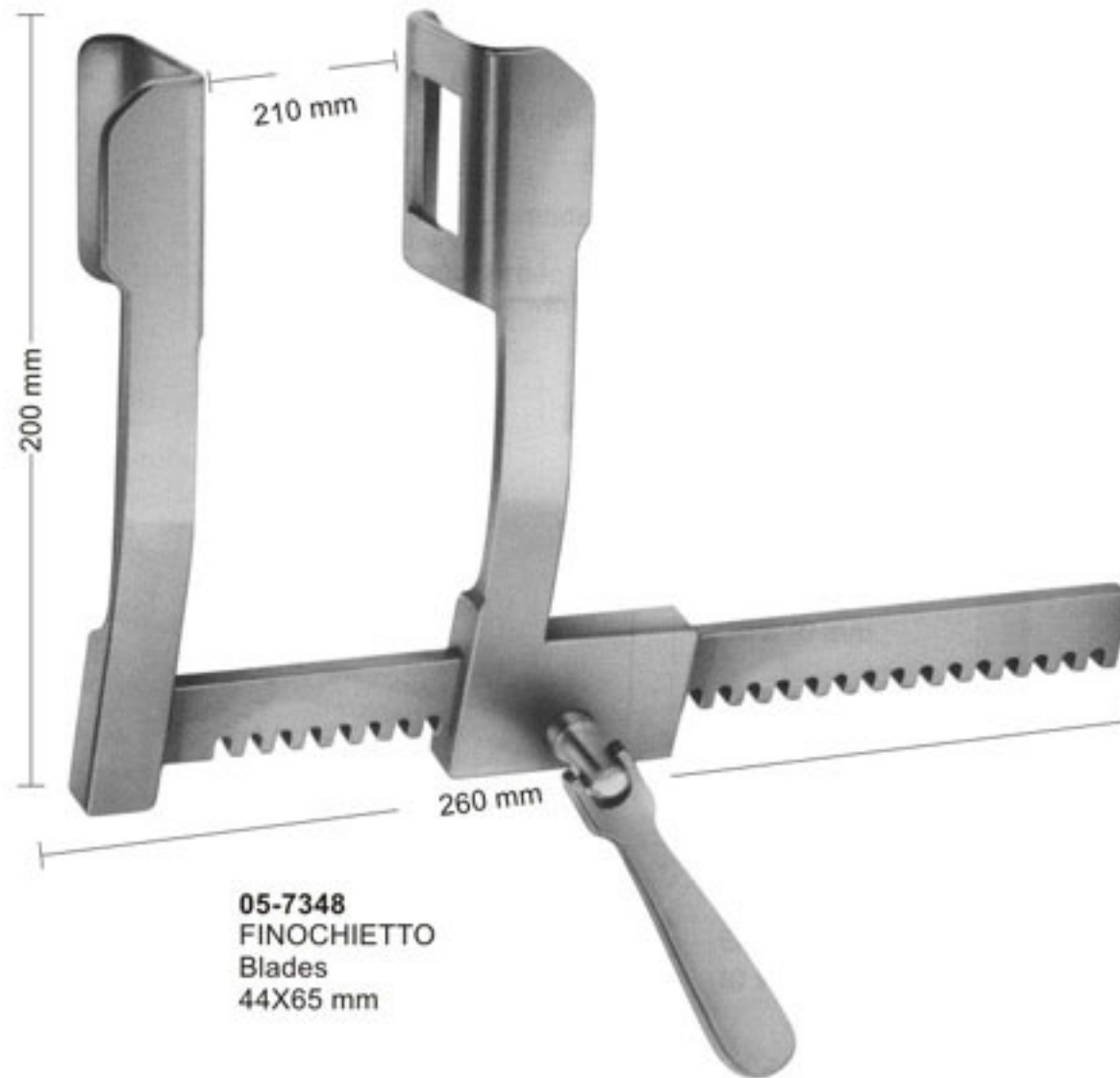

**05-7348**  
FINOCHIETTO  
Blades  
44X65 mm

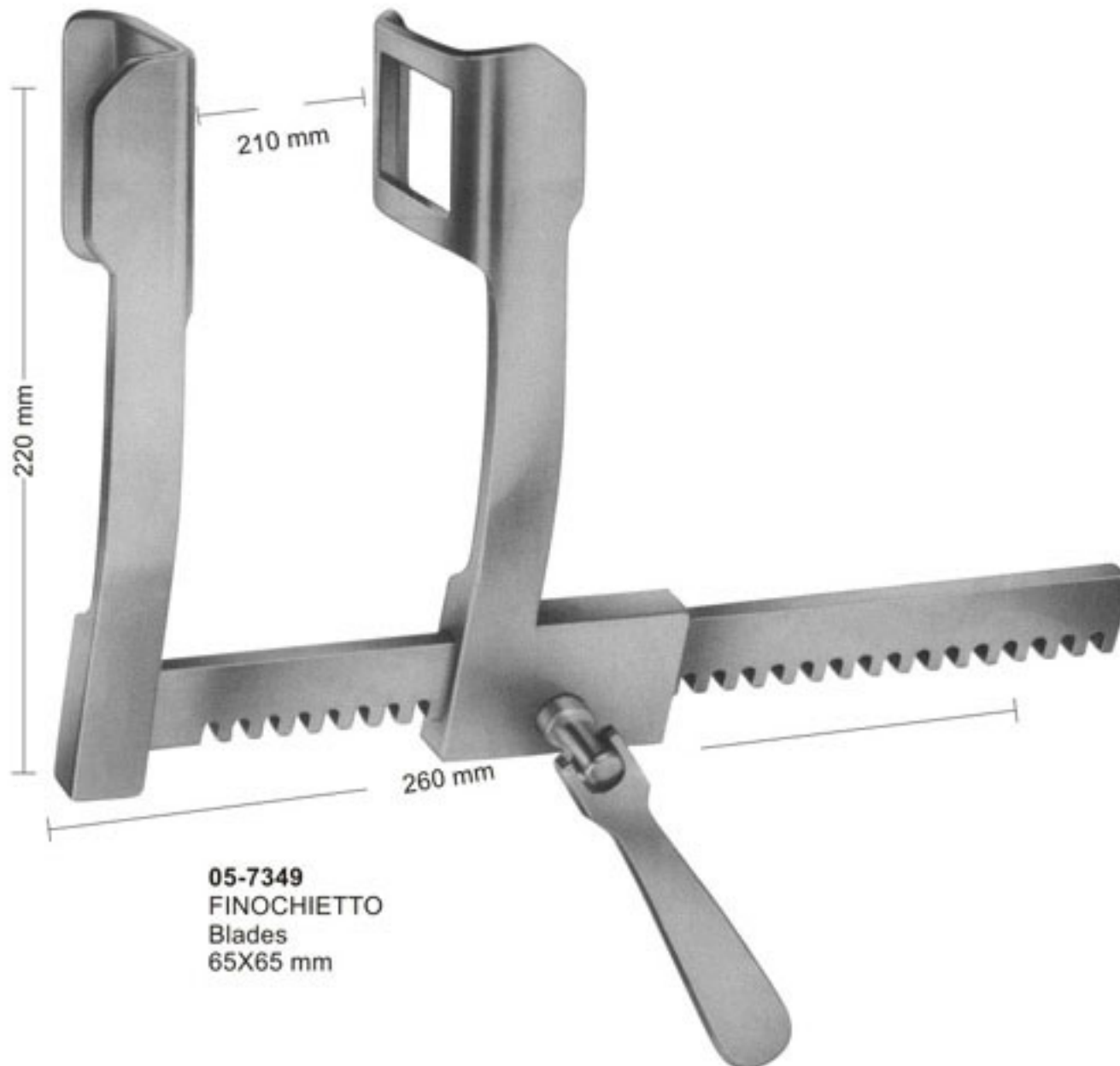

**05-7349**  
FINOCHIETTO  
Blades  
65X65 mm



# Rib Spreaders



**05-7351**  
Blades  
30x80 mm



**05-7352**  
Blades  
40x67 mm



**05-7353**  
Blades  
80x67 mm



220 mm

220 mm

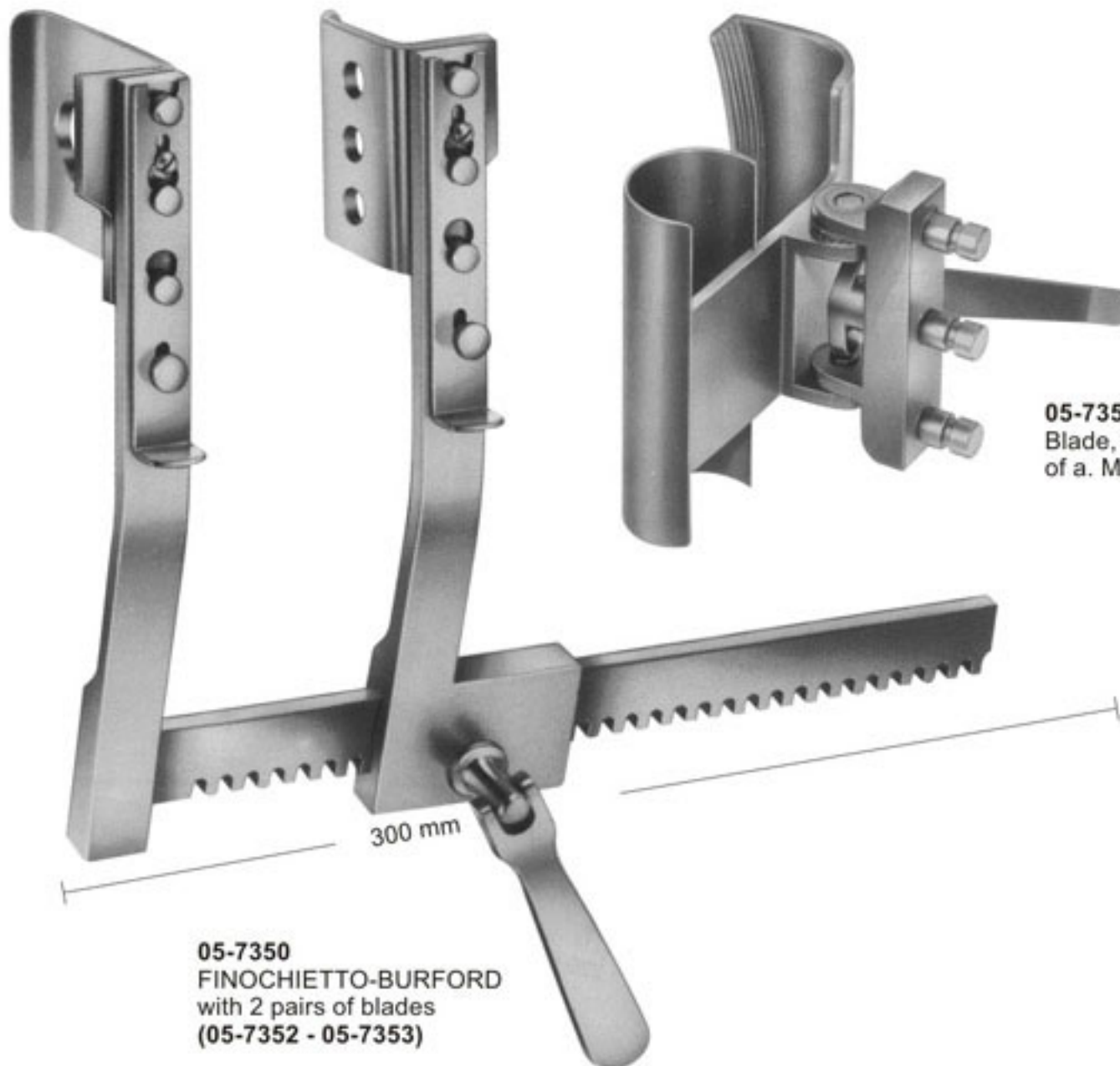

**05-7350**  
FINOCHIETTO-BURFORD  
with 2 pairs of blades  
(05-7352 - 05-7353)

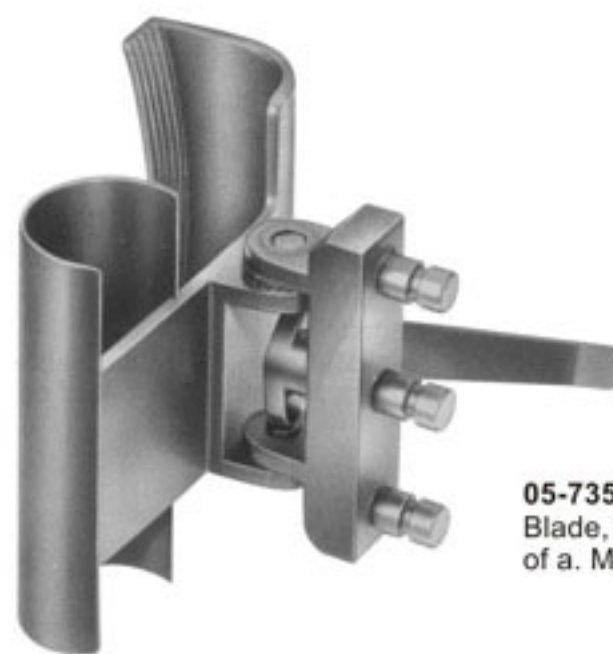

**05-7354**  
Blade, Only, for preparation  
of a. Mammaria, 25.5x80mm

300 mm





# Rib Spreaders

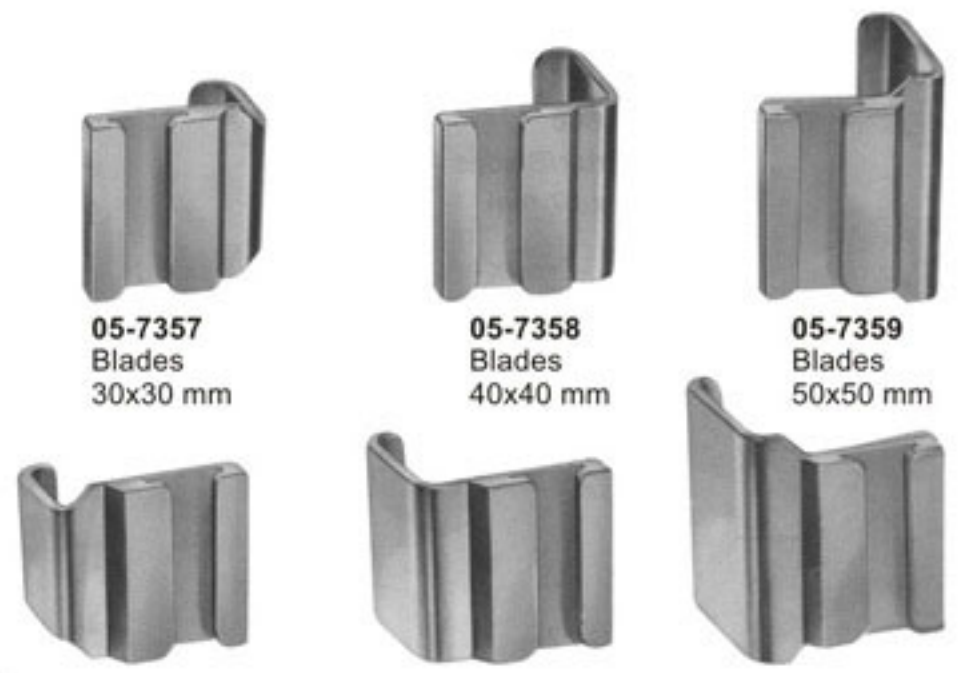
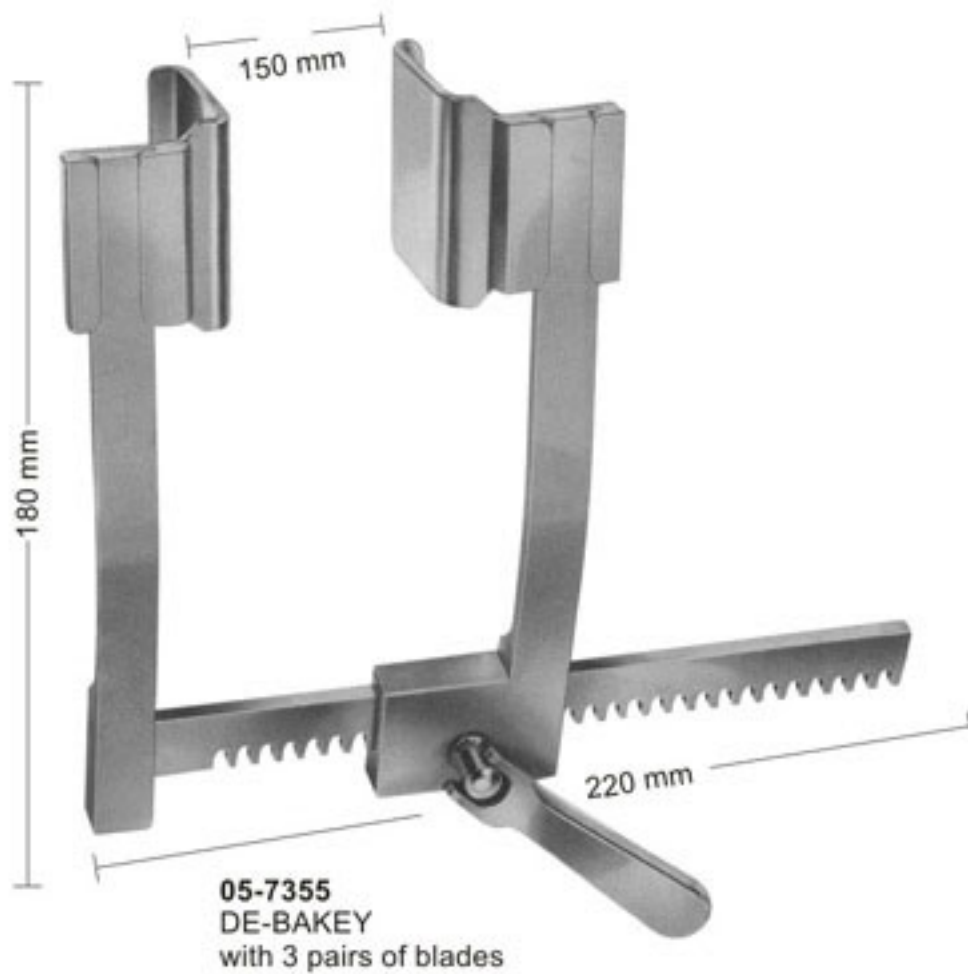

Components for **05-7355**  
 Spreader only      Blades only  
**05-7356**      **05-7357** 30x30mm  
                   **05-7358** 40x40mm  
                   **05-7359** 50x50mm  
 The Blades are delivered in Pairs.

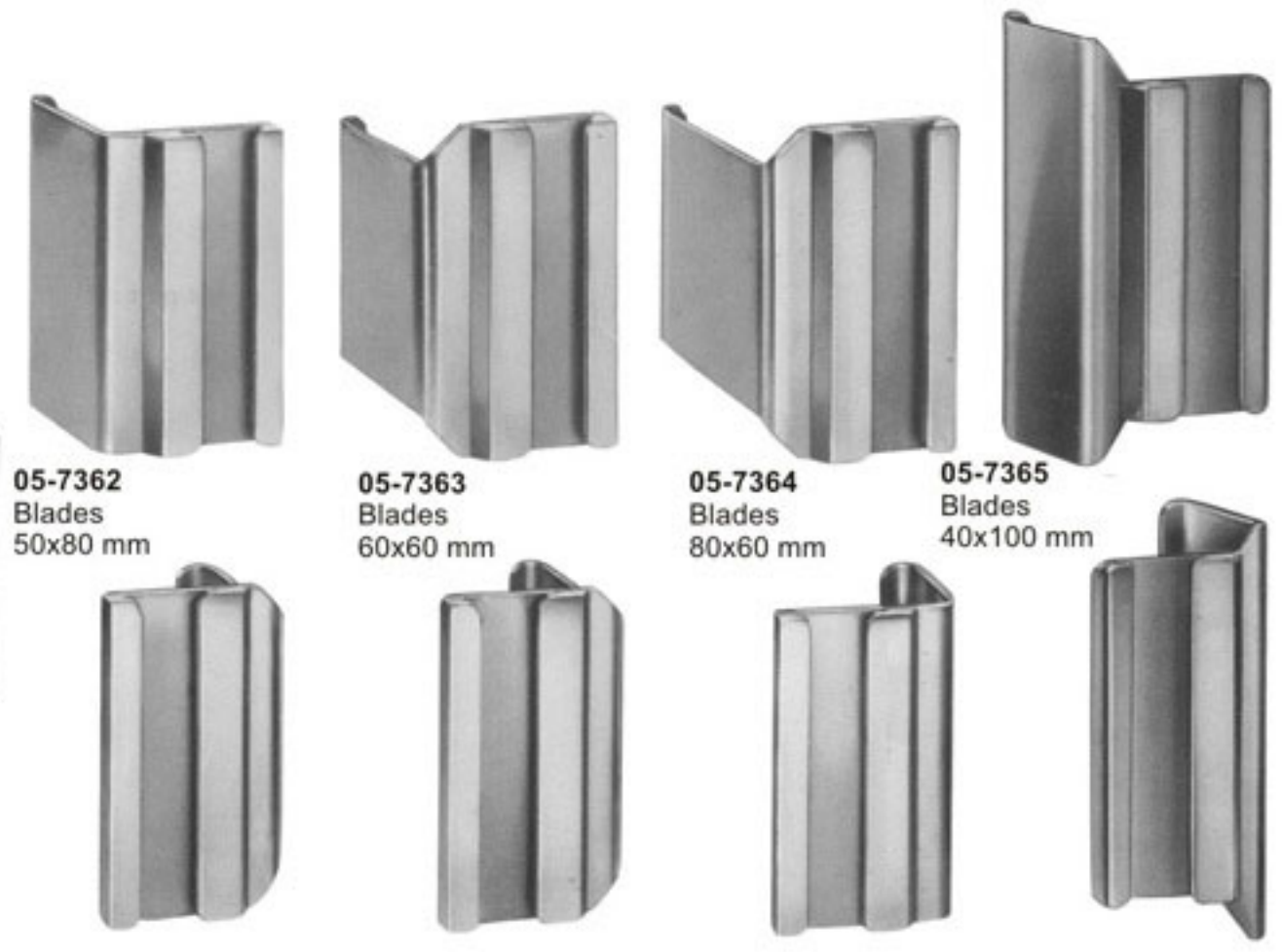
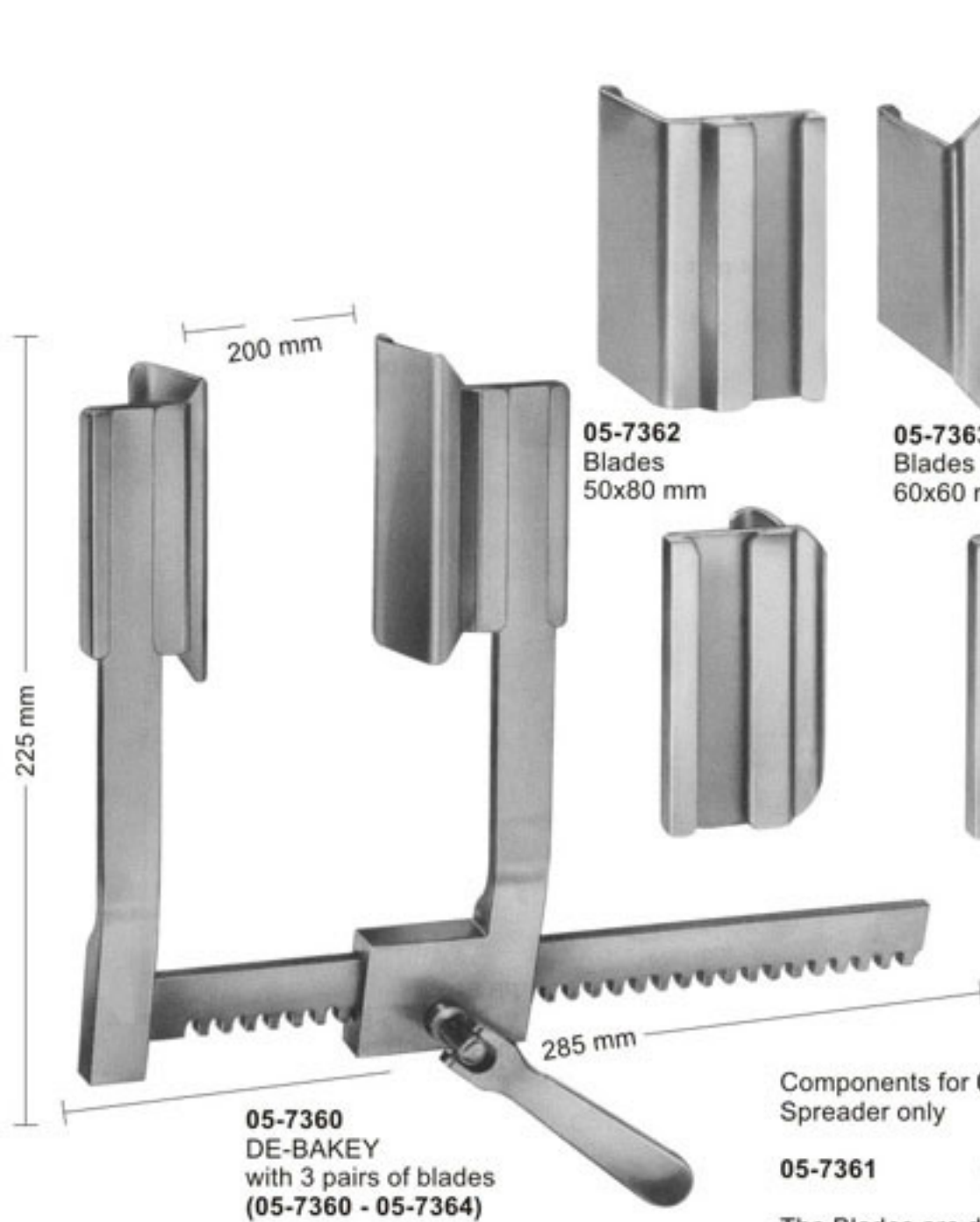

Components for **05-7360**  
 Spreader only      Blades only  
**05-7361**      **05-7362** 50x80mm  
                   **05-7363** 60x60mm  
                   **05-7364** 40x100mm  
 The Blades are delivered in Pairs.





## Sternotomy Spreaders

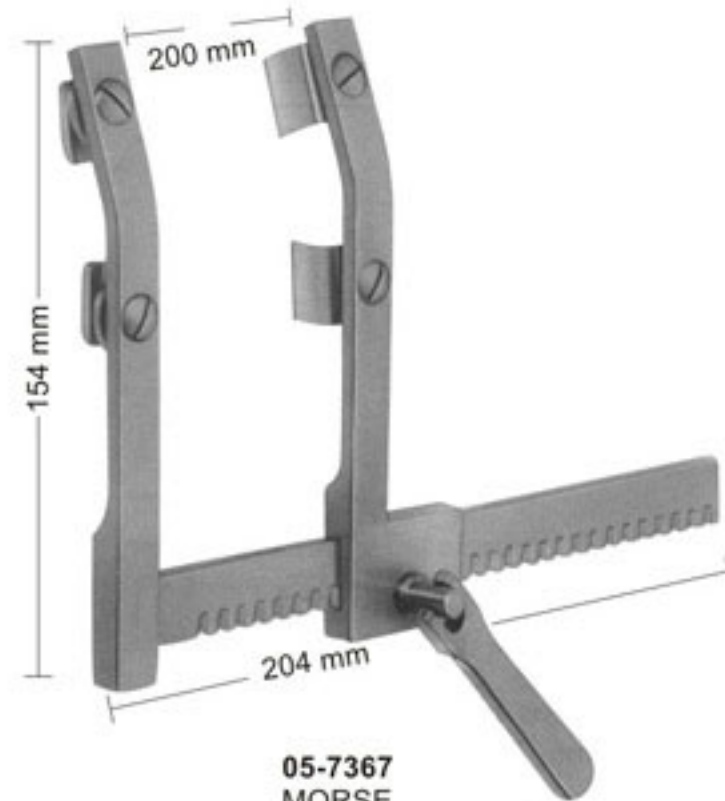

**05-7367**  
MORSE  
Sternotomy spreader  
for children, with moveable  
double, blades each blade  
12x20 mm

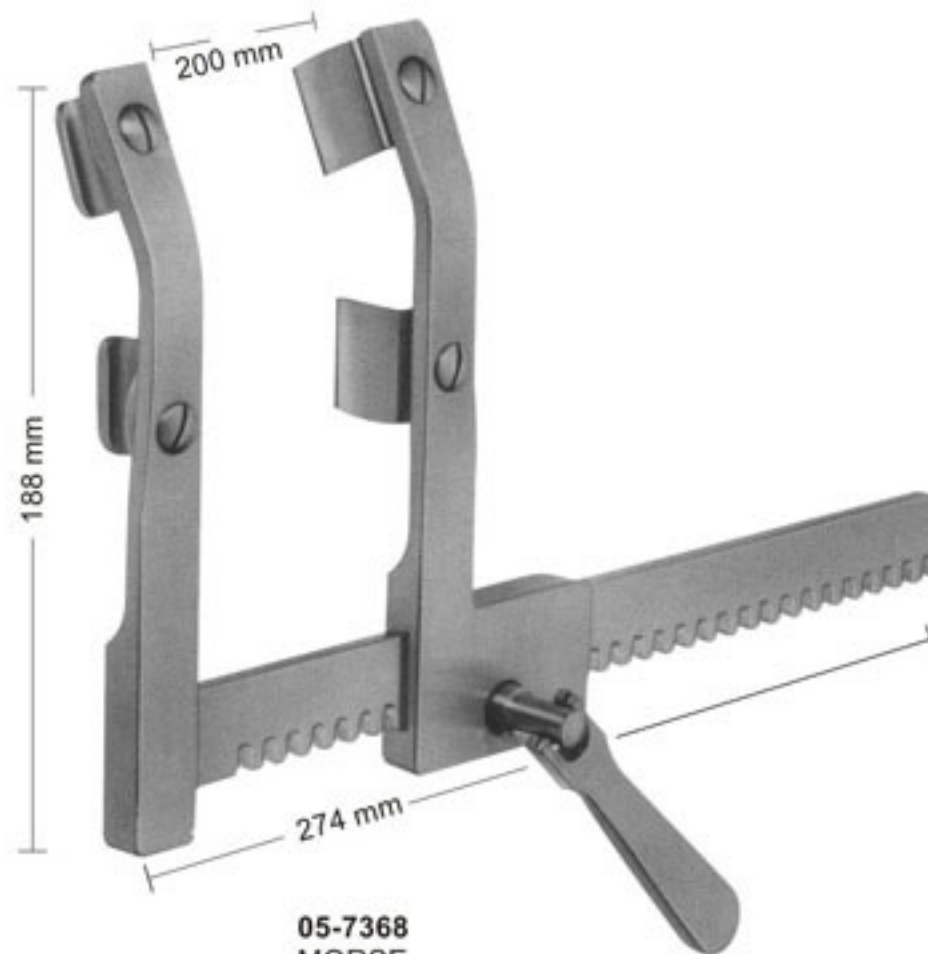

**05-7368**  
MORSE  
Sternotomy spreader  
for adults, with moveable  
double, blades each blade  
19x19 mm





# Sternotomy- Spreaders

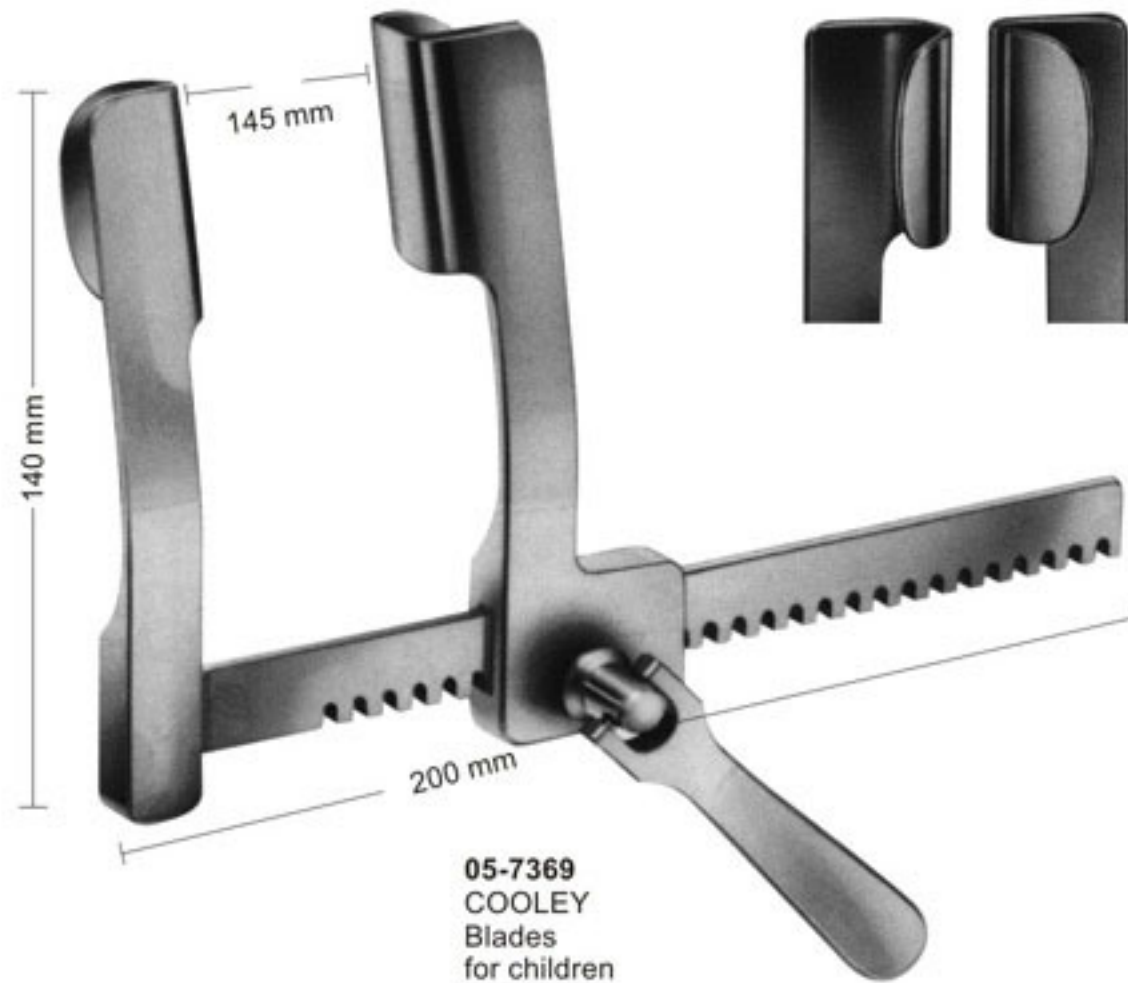

**05-7369**  
COOLEY  
Blades  
for children  
21x45mm

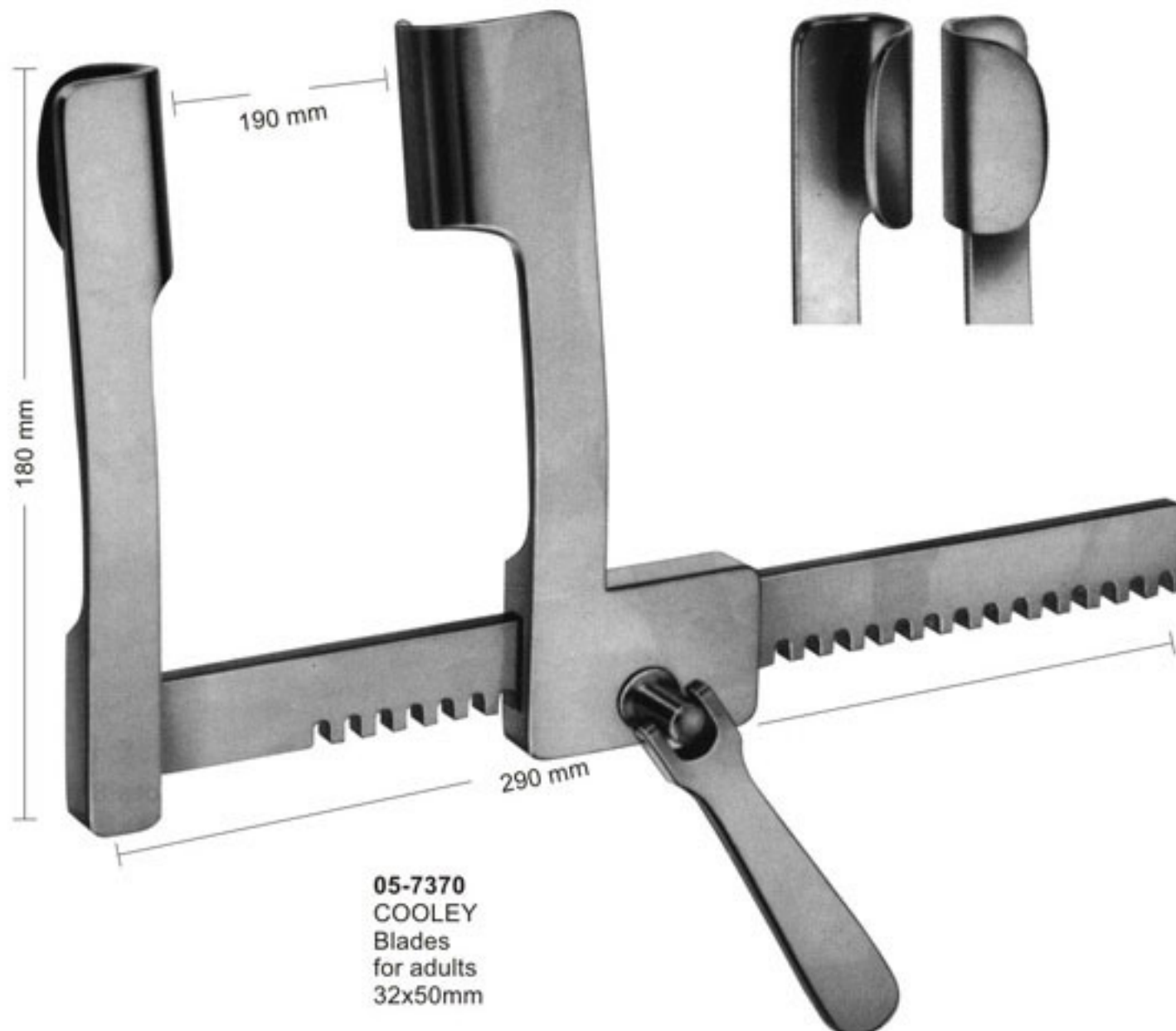

**05-7370**  
COOLEY  
Blades  
for adults  
32x50mm



# Thoracic Retractors



**05-7371**  
Blades  
75x75 mm



**05-7373**  
Blades  
42x65 mm

Blades with Ball Snap System  
Delivery: in Pairs

- 05-7371 - 05-7373**  
Thoracic Retractor (Mercedes-Retractor)  
complete consisting of:
- 05-7371** Retractor only
  - 05-7372** 1 Pair of blades 75x75 mm
  - 05-7373** 1 Pair of blades 42x65 mm





# Rib Spreaders-and Contractors



**05-7374**  
**SELLORS**  
Rib spreader-and contractor  
with swivel blades  
200 mm



**05-7375**  
**BAILEY**  
150 mm



**05-7376**  
for children

**05-7377**  
for adults

**05-7376 - 05-7377**  
**BAILEY**  
200 mm



# Retractors, Lung Spatulas

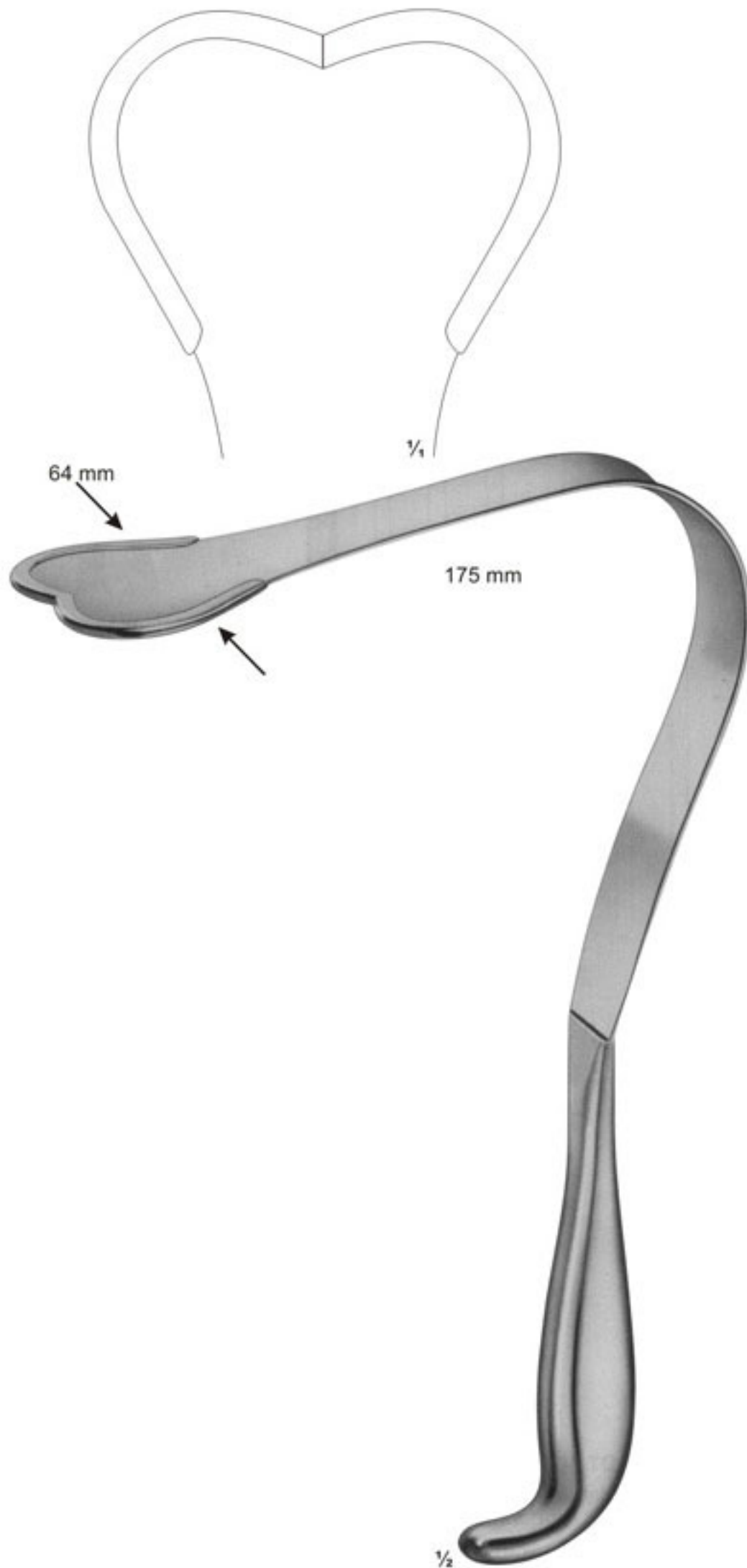

**05-7378**  
HARRINGTON-PEMBERTON  
flexible  
295 mm

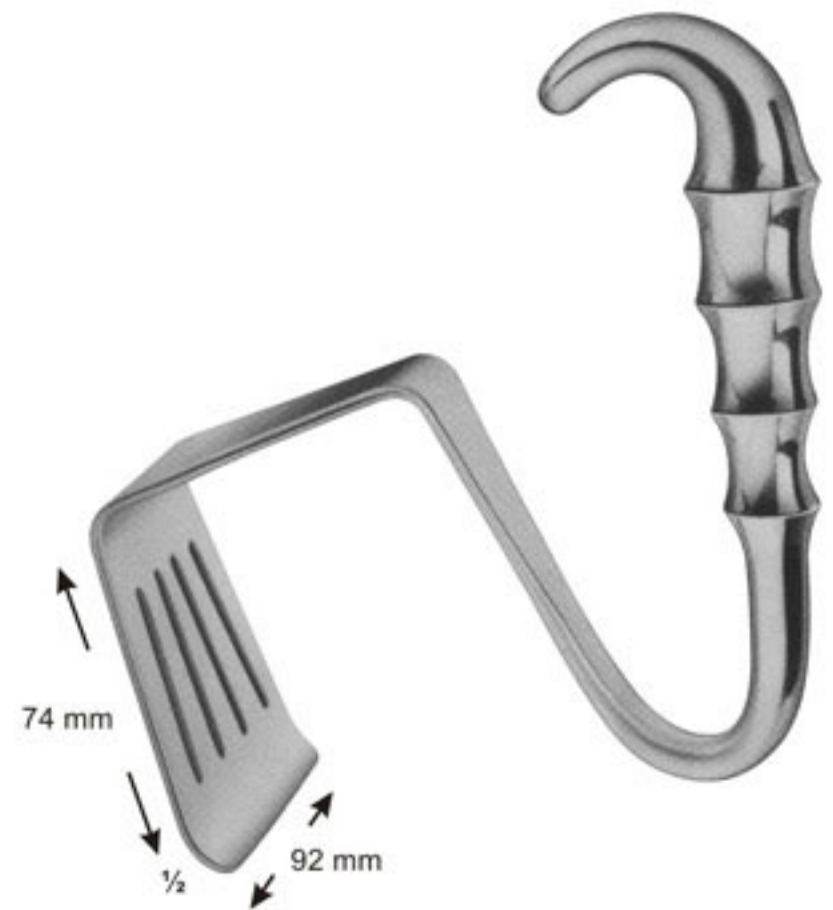

**05-7379**  
DAVIDSON  
Scapula retractor





# Lung Spatulas, Suction Cannulae

