

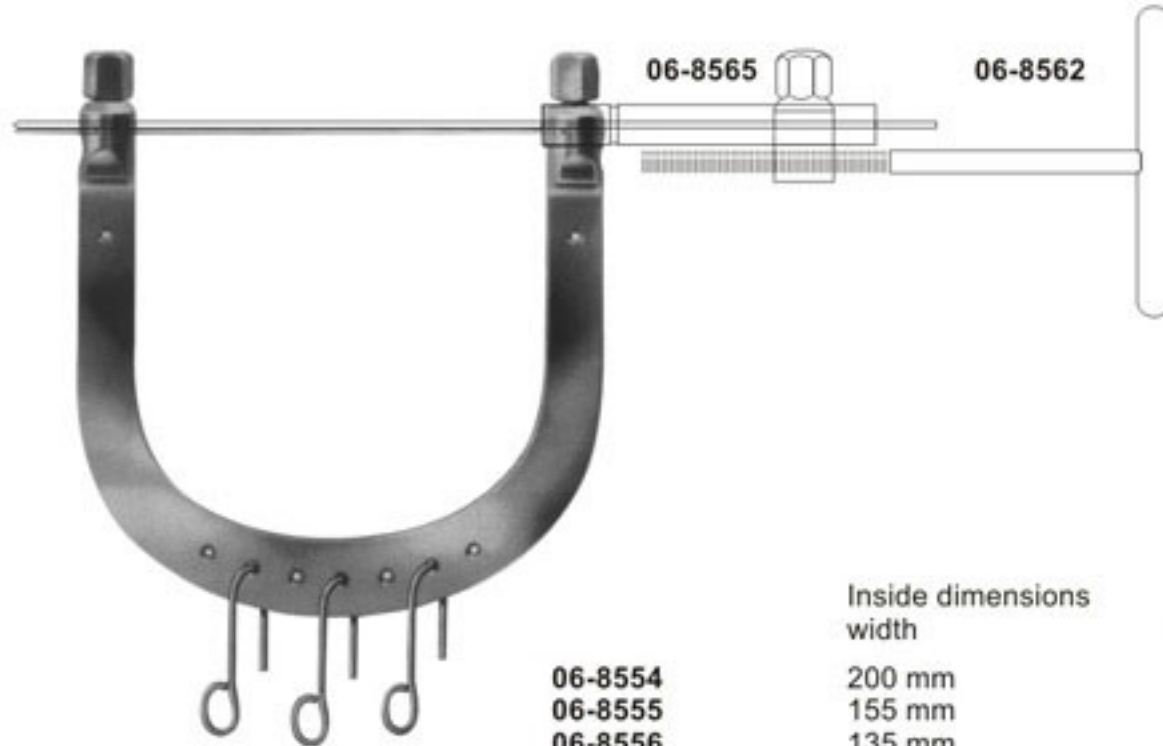

Wire Extension



06-8554 - 06-8560
KIRSCHNER
 Wire traction bows,
 to be used with
 KIRSCHNER-wires
 up to 2.5 mm diam.,
 With 3 hooks,
 stainless steel

	Inside dimensions width	depth	
06-8554	200 mm	155 mm	for the hip
06-8555	155 mm	155 mm	for the femur
06-8556	135 mm	130 mm	for the knee
06-8557	120 mm	120 mm	for the knee
06-8558	105 mm	100 mm	for the knee
06-8559	95 mm	110 mm	for the calcaneus
06-8560	95 mm	70 mm	for the arm and elbow



06-8561
 Wrench, double - ended,
 for wire traction bows



06-8562
 Wire tightener, with
 clamping jaws



06-8563
 Traction hook only,
 large size



06-8564
 Traction hook only,
 small size



06-8565
 Fixation clamp, to secure clamping
 jaws of **06-8562** stainless steel



Wire Extension

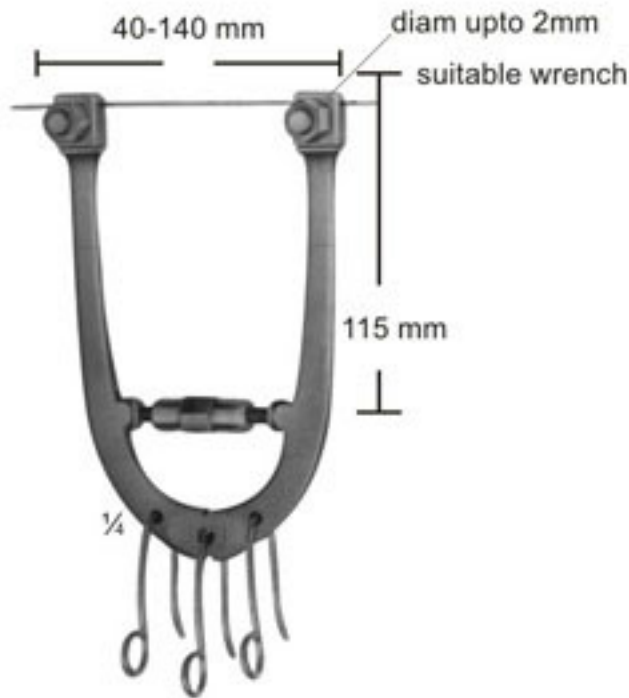

06-8566
Wire traction bow, adjustable, with 3 hooks, small size

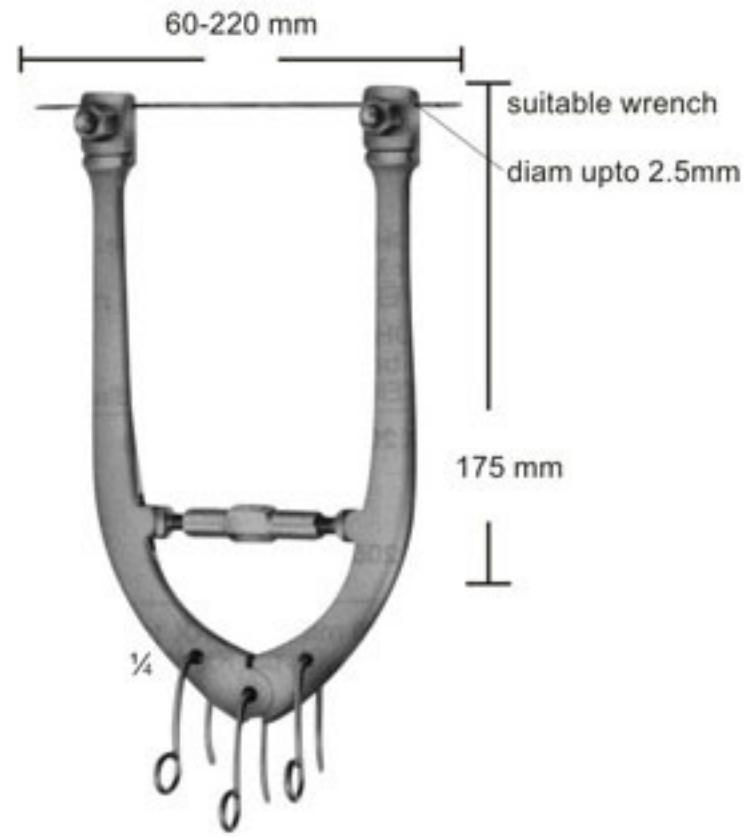

06-8567
Wire traction bow, adjustable, with 3 hooks, large size

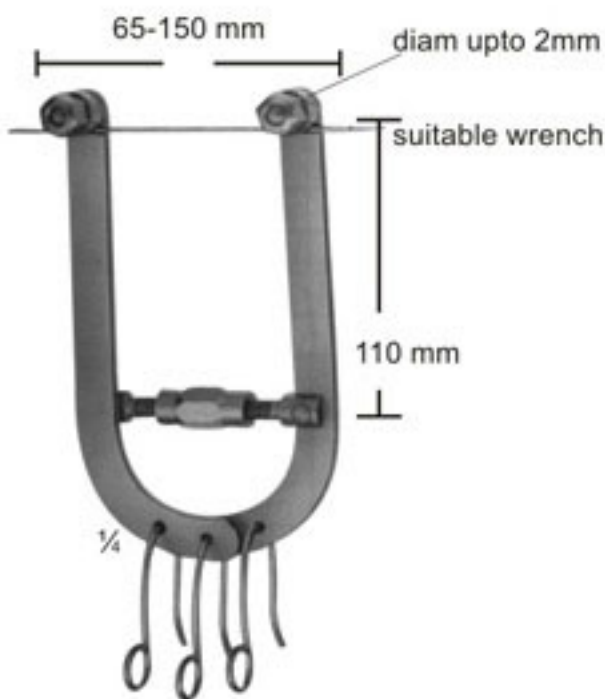

06-8568
Wire traction bow, adjustable, with 3 hooks, small size for elbow and calcaneus, for adolescents



06-8569	max. 105 mm
06-8570	max. 160 mm
06-8571	max. 200 mm
06-8569	80-95 mm
06-8570	90-120 mm
06-8571	140-170 mm
diam upto	
06-8569	1,6 mm
06-8570	2,0 mm
06-8571	2,5 mm

06-8569 - 06-8571
KIRSCHNER
Wire traction bows, modified, adjustable in width, holds wire securely, with 1 hook



06-8572
Fixation disc, slotted



06-8574
Fixation disc, slotted



06-8573
idem, aluminum, transparent to X-rays



06-8575
Screw driver, for above fixations discs



Traction Bows, Distractor



Boehler traction bows, to be used with STEINMANN pins, 4mm diam	Boehler traction bows, to be used with STEINMANN pins, 5mm diam	Inside width	For
06-8576 with pin (09-8588)		16x9cm	Arm
06-8577 without pin	06-8582 without pin		
06-8578 with pin (09-8590)		21x11cm	Femur and knee
06-8579 without pin	06-8583 without pin		
06-8580 with pin (09-8592) 06-8581 without pin		21x15cm	Femur and knee



06-8584 - 06-8598
STEINMANN
triangular shaft ended and trocar point

diam ϕ	4,0 mm	5,0 mm
Length		
80 mm	06-8584	
100 mm	06-8585	
120 mm	06-8586	
140 mm	06-8587	
150 mm	06-8588	06-8594
160 mm	06-8589	
180 mm	06-8590	06-8595
200 mm	06-8591	06-8596
210 mm	06-8592	
250 mm	06-8593	06-8597
300 mm		06-8598



06-8599
SCHWARZ
Traction bow for fingers,
to be used with KIRSCHNER-
wire up to 1.6 mm diam.



06-8600
Small distractor
as a repositioning device for
distraction and compression of small bones,
for wires with 3.0 mm diam.



06-8601
Protection cap
for 4,0 mm STEINMANN Pins



06-8602
Protection cap
for 5,0 mm STEINMANN Pins



Drilling Chucks and Cerclage Wire Tightener



1/2

06-8603
REILL
Drilling chuck, cannulated, for shanks from 2.0 - 2.5 mm diam 115 mm



1/2

06-8604
Drilling chuck, cannulated, for shanks from 0.8 - 2.0 mm diam 150 mm



1/2

06-8605
Drilling chuck, cannulated, for shanks up to 4.5 mm diam with key 140 mm



1/2

Movable tip made of (material used for implants). While twisting the movable head remains stable, therefore the wire will not slip off.

06-8606
LOUTE
Wire tightener, improved pattern, with movable tip, for wires up to 1.0 mm diam. 220 mm

Chuck jaws made of material used for implants



1/2

06-8607
Drilling chuck, cannulated, for shanks up to 6.35 mm diam., To be tightened by hand 100 mm



1/2

06-8608
Drilling chuck, cannulated, for shanks up to 4.5 mm diam., And for triangular shaft width across flats 4.7 mm (schanz screws, steinmann pins). with key **06-8609**



1/2

06-8610
Drilling chuck, cannulated, for shanks up to 6.35 mm diam., With key (**06-8611**) 160 mm



Cerclage Instruments

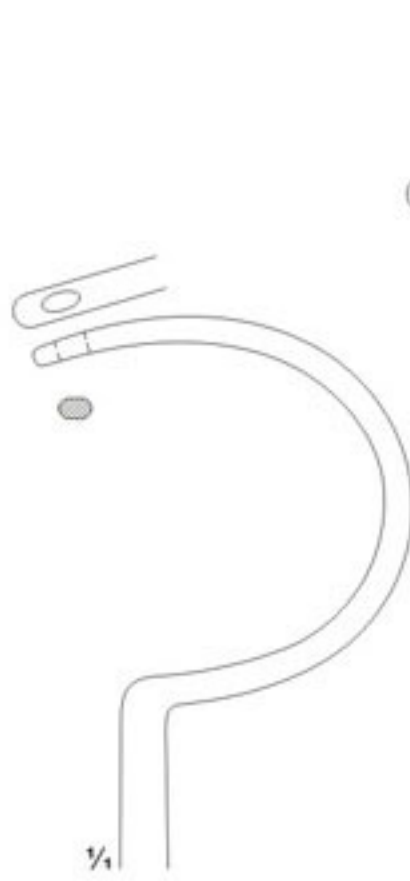

06-8612
275 mm

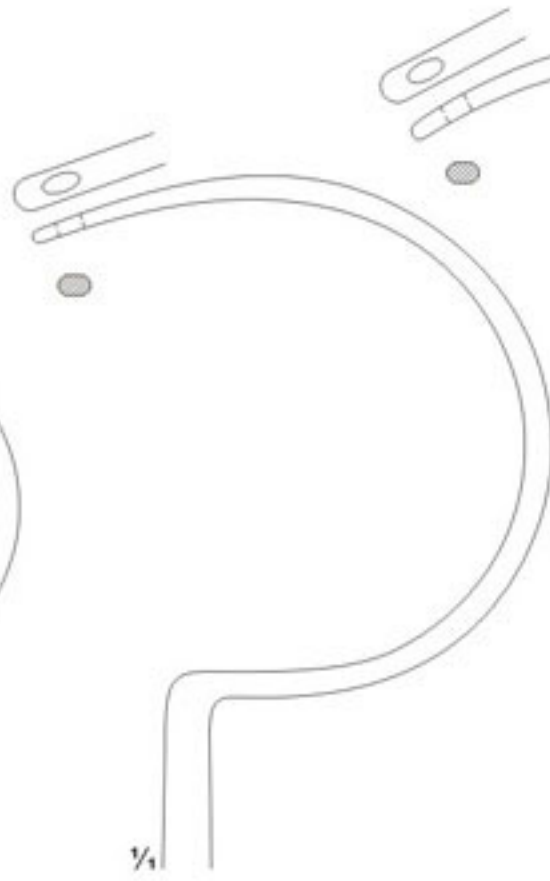

06-8613
285 mm

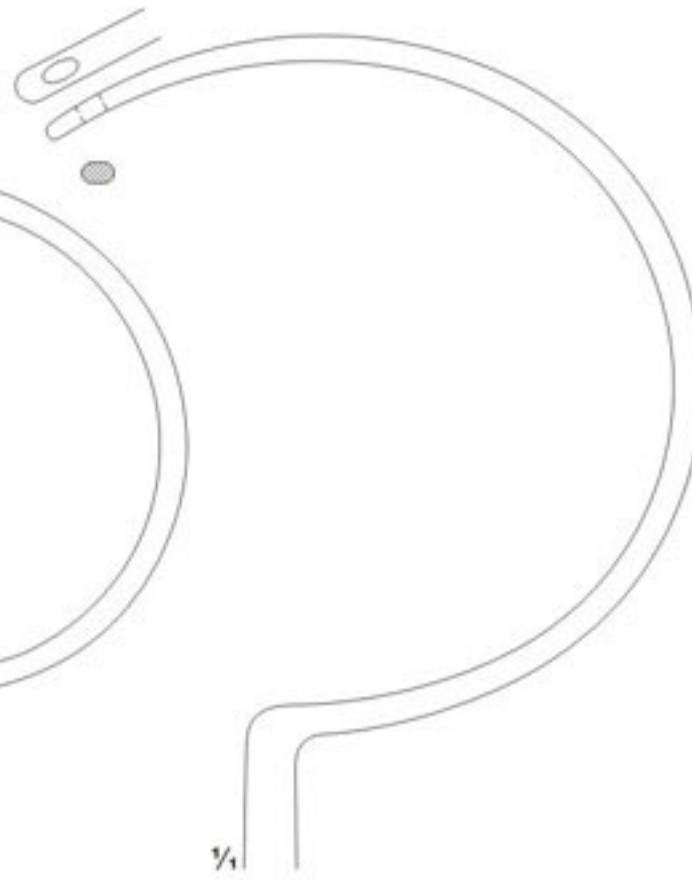

06-8614
305 mm



06-8612 - 06-8614
DEMEL
Wire guides

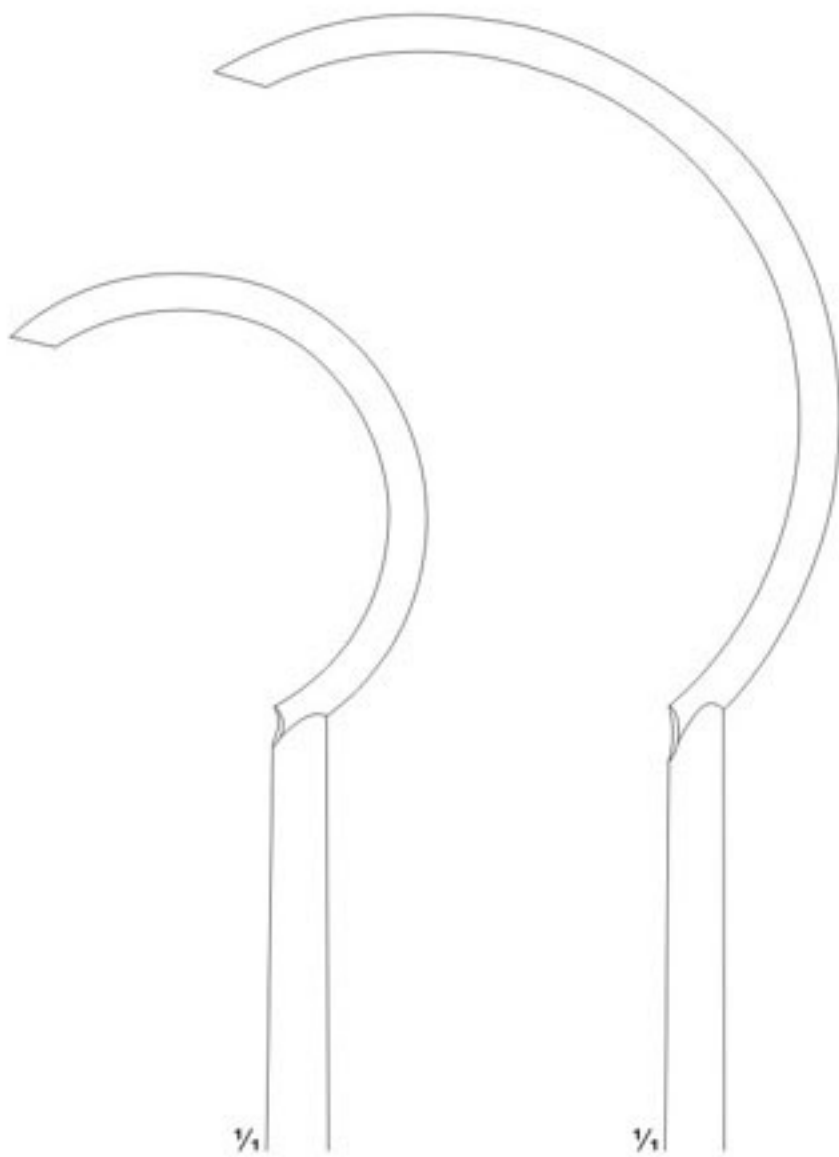

06-8615
240 mm



06-8616
270 mm



06-8617
225 mm



JORDAN instruments for subcutaneous Tibia Cerclage

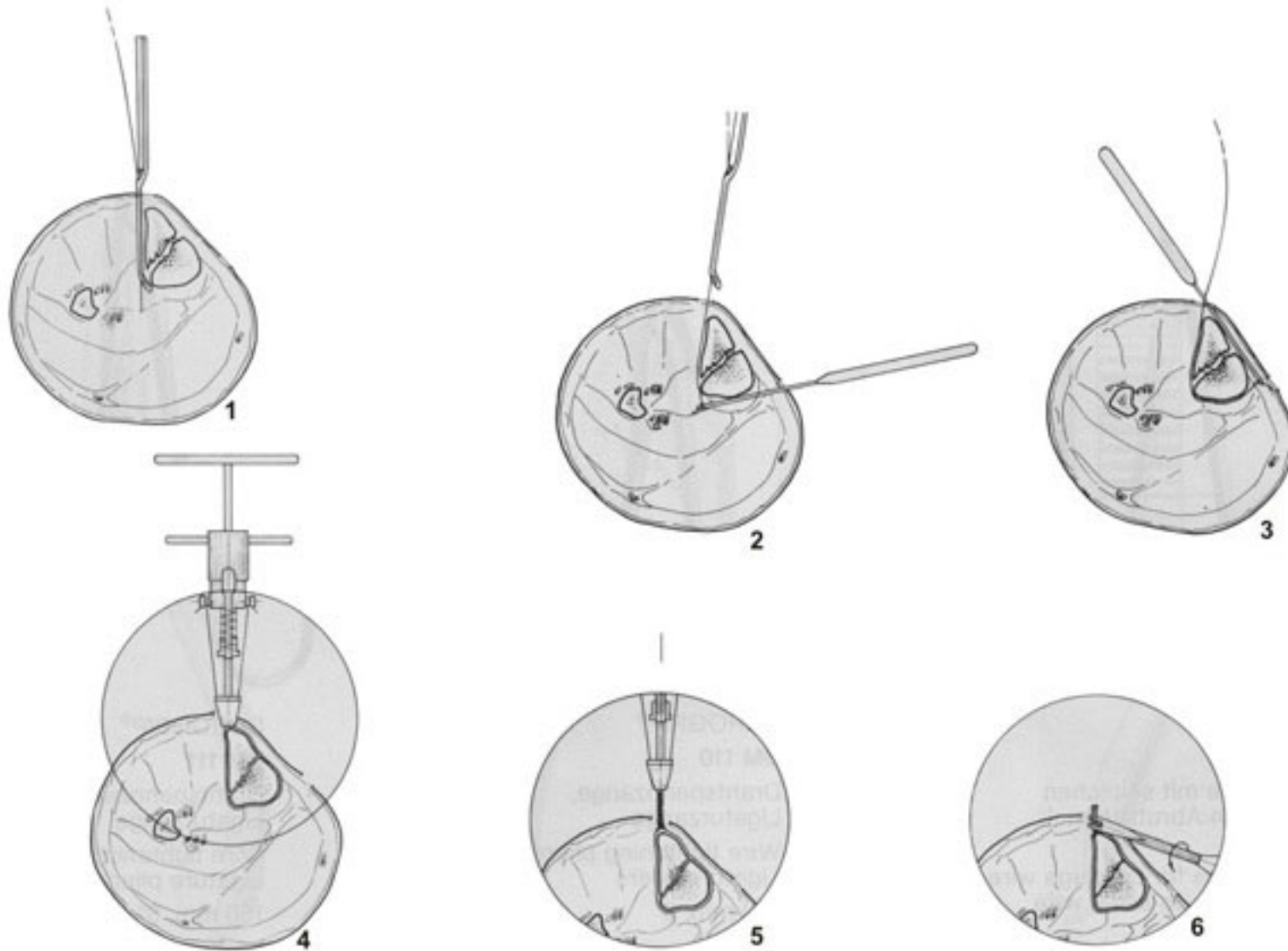

06-8618
JORDAN
Wire tightener



$\frac{1}{2}$
06-8619
JORDAN
Wire twister
170 mm



$\frac{1}{2}$
06-8620
JORDAN
Wire catcher
180 mm



$\frac{1}{2}$
06-8621
JORDAN
Probe, cannulated
170 mm



Wire Holding forceps, Wire Tightening Pliers, Flat-nosed Pliers DUROGRIP with Hard Metal Inserts



06-8622
DUROGRIP
Holding forceps for cerclage wire, with lateral jaws to avoid wire slipping off
170 mm



06-8623
DUROGRIP
Wire, tightening pliers, Ligature pliers
150 mm



06-8624
DUROGRIP
Wire, tightening pliers, Ligature pliers
150 mm



06-8625
with serrated jaws
140 mm



06-8626
one jaw smooth, one jaw serrated
140 mm



06-8627
with serrated jaws
06-8628
with longitudinal and transversal grooves
170 mm



06-8629
190 mm



Wire Holding forceps, Flat-nosed Pliers, Pliers for bending and cutting wires

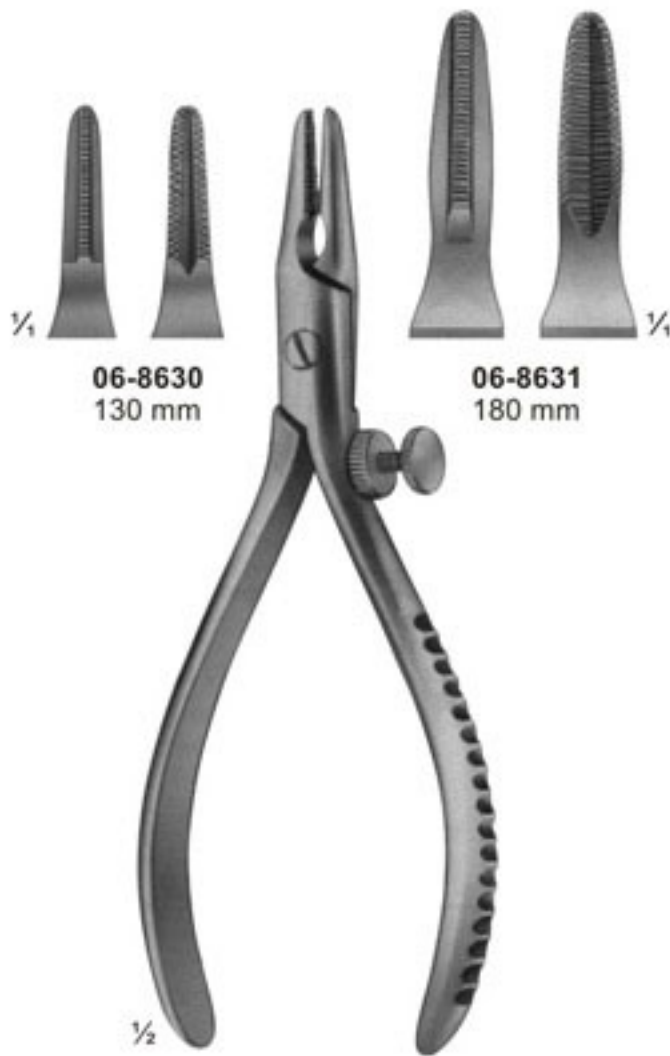

06-8630
130 mm

06-8631
180 mm

06-8630 - 06-8631
Extraction pliers
for boring wires



06-8632
Flat-nosed pliers,
parallel
185 mm

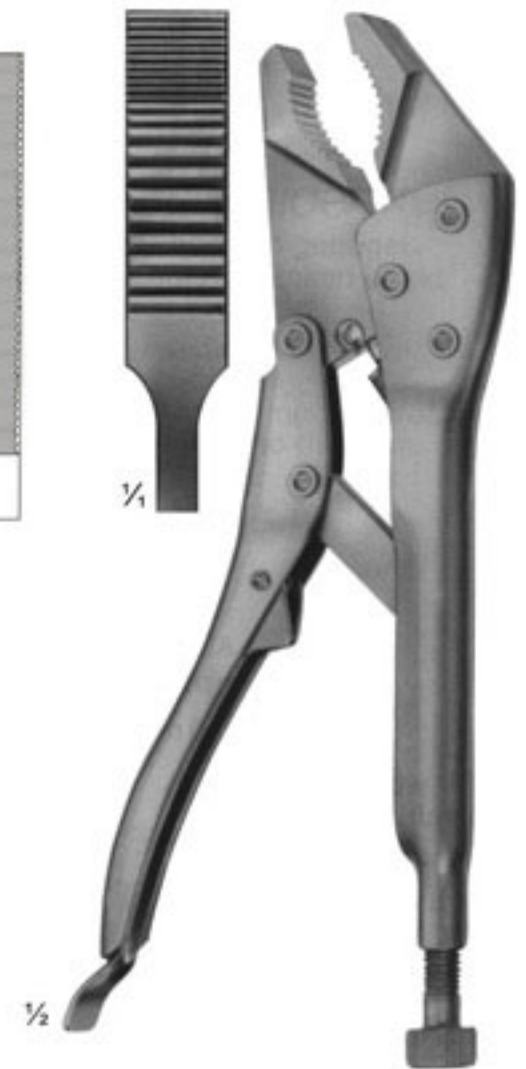

06-8633
Vise grip
200 mm

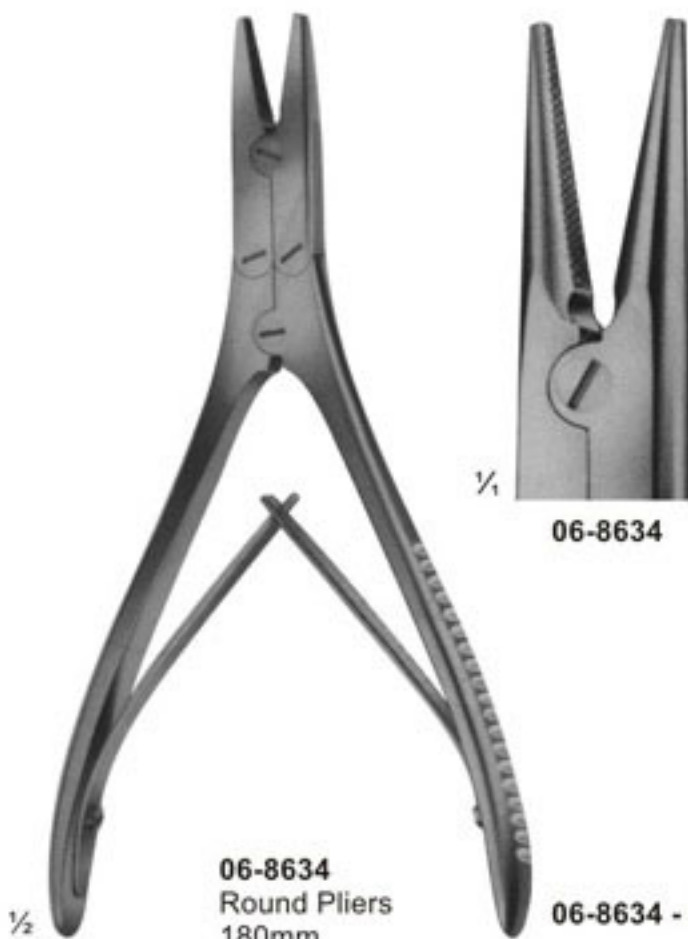

06-8634
Round Pliers
180mm

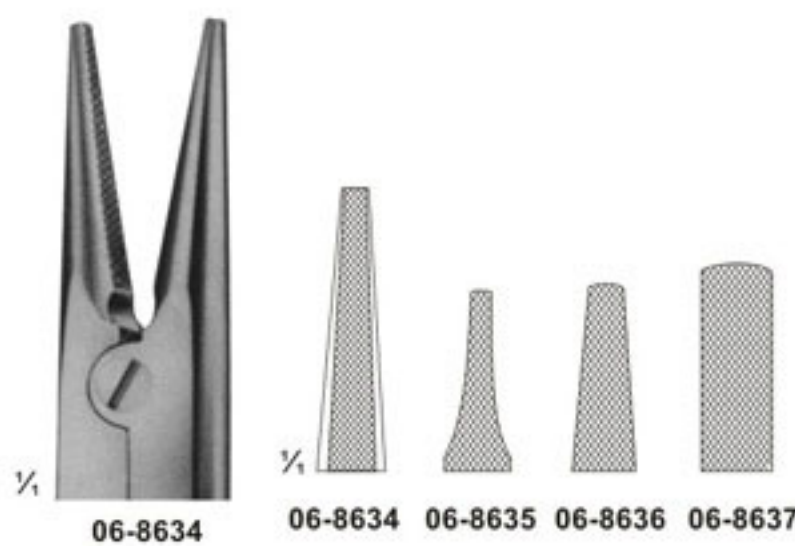

06-8634

06-8634

06-8635

06-8636

06-8637

06-8635 145 mm
06-8636 180 mm
06-8637 180 mm
Extraction pliers for wires

06-8634 - 06-8637



06-8638
Bending pliers
for wires up to
1.8 mm diam.



Wire Cutters and wire Cutting Scissors DUROTIP with Carbide Cutting Edges



06-8639
ANGLE
130 mm

for soft wire
up to diam.
for hard wire
up to diam.

0,5 mm
0,3 mm

06-8640
DUROTIP
ANGLE
130 mm

0,6 mm
0,4 mm

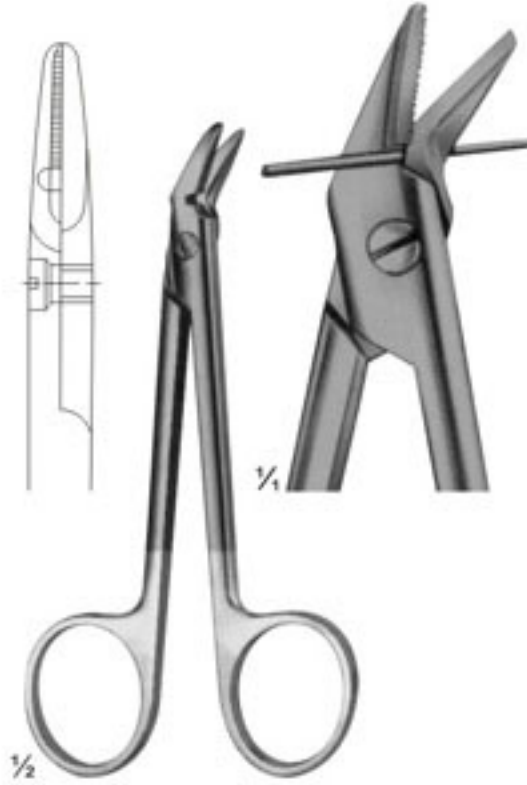

06-8641
120 mm

for soft wire
up to diam.
for hard wire
up to diam.

1,2 mm
0,8 mm

06-8642
DUROTIP
120 mm

1,2 mm
0,8 mm

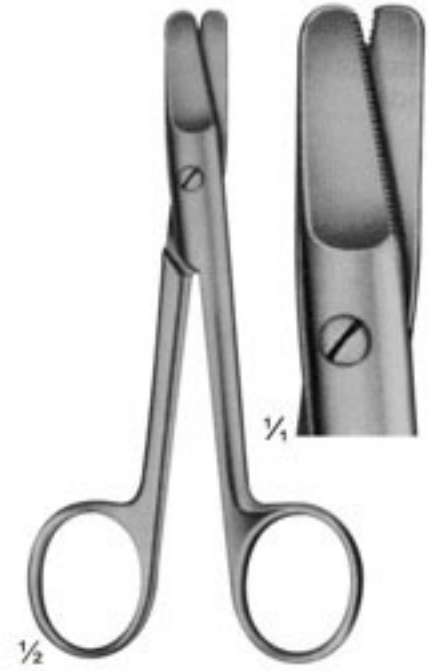

06-8643
HARVEY
125 mm

0,4 mm
0,3 mm



06-8644
150 mm

for soft wire
up to diam
for hard wire
up to diam

1,5 mm
1,0 mm



06-8645
160 mm

1,5 mm
1,2 mm



06-8646
140 mm
DUROTIP
1,5 mm

1,0 mm



Wire Cutting Pliers, Lateral Cutting Action



06-8647
180 mm

for soft wire
up to diam. 2,0 mm
For hard wire 1,5 mm
up to diam
specially hardened
cutting edges, front
and lateral cutting
action



06-8648
REILL
175 mm

for soft wire
up to diam. 2,0 mm
For hard wire 1,6 mm
up to diam
specially hardened
cutting edges, for
cutting off wires close
to the bone



DUROTIP

06-8649
235 mm

for soft wire
up to diam. 3,0 mm
For hard wire 2,2 mm
up to diam



Wire Cutting Pliers, Lateral and Front Cutting Action



06-8650
240 mm

for soft wire up to diam. 2,0 mm
For hard wire up to diam. 1,6 mm



06-8651
145 mm

for soft wire up to diam. 1,5 mm
For hard wire up to diam. 1,0 mm



06-8652
145 mm

for soft wire up to diam. 2,0 mm
For hard wire up to diam. 1,5 mm



06-8653
220 mm

for soft wire up to diam. 3,5 mm
For hard wire up to diam. 2,5 mm



Wire Cutting Pliers



06-8654
320 mm

for soft wire
up to diam. 3,0 mm
For hard wire
up to diam 3,0 mm



Cutter for cutting off
KIRSCHNER wires,
Tibia head screws,
bolts, pins, up to 3 mm diam.



DUROTIP

06-8655
Cutter for cutting off
KIRSCHNER wires,
Tibia head screws,
bolts, pins, up to 6 mm diam.
470 mm



Finger Nail Instruments

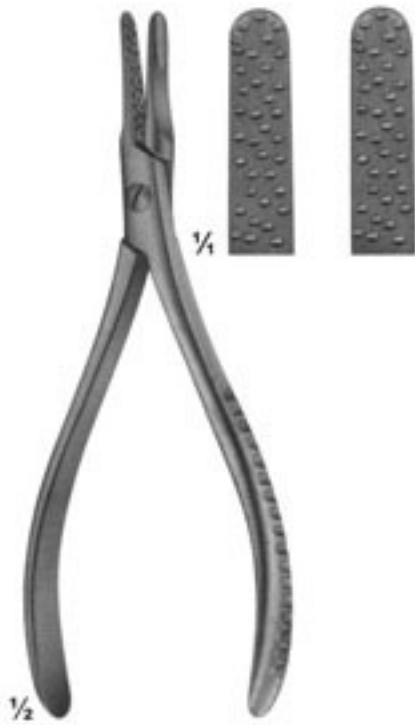

06-8656
Nail extracting
forceps
135 mm



06-8657
Nail extracting
forceps
145 mm



06-8658
Finger nail drill
with 3 drill points

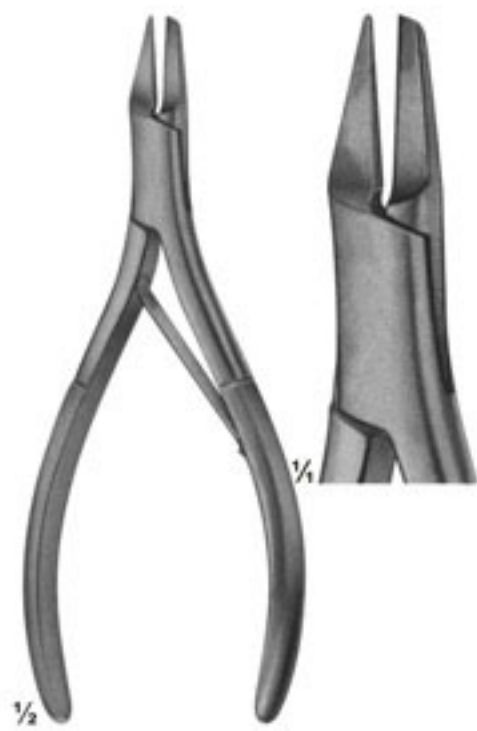

06-8662
Nail splitting
forceps
135 mm



06-8663
SYSTRUNK
Scissors, for splitting
finger nails
130 mm



06-8664
Finger ring saw
150 mm